

# Pure & Safe

Fitting for Potable Water,  
Beverages & Drink Dispense

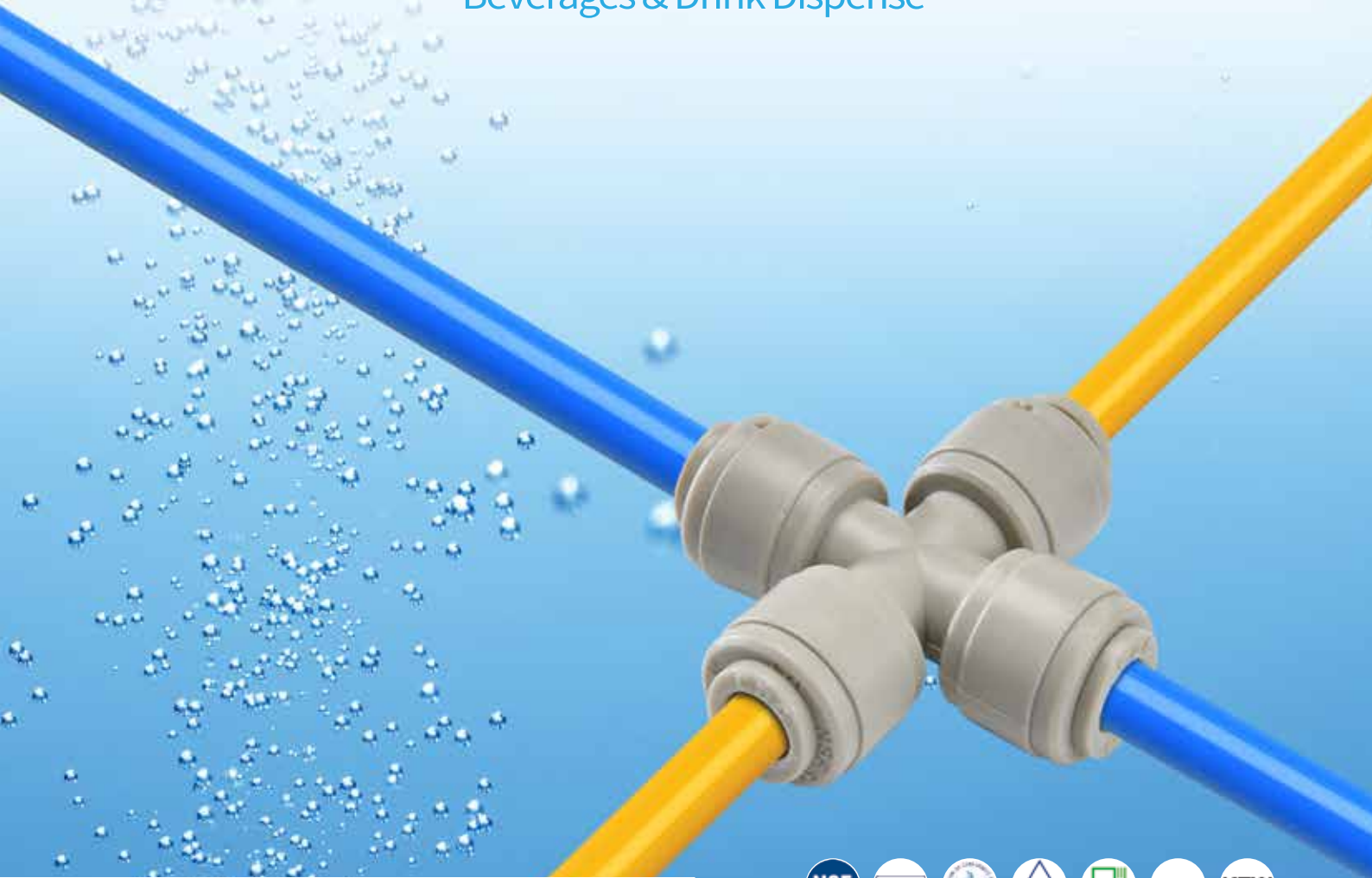

[www.fluidfit.net](http://www.fluidfit.net)



## About Us



1

### Reliable product

“Fluidfit” has established to produce fittings and valves for water, beverages and drinks dispense. Fluidfit is certified by ISO9001 and ISO14001 in quality management and environmental management system. Fluidfit has been material requirement certified by NSF51/61, WRAS, ICIM, KTW, and ACS.

2

### Easy operation

Fluidfit is one-touch connection type without tools. It provides workers with more comfortable working environment. Fluidfit is highly suitable for water, beverages and drinks dispense.

3

### Pure and Safe

Fluidfit is pure and safe. Fluidfit has produced environment working conditions and high technology equipment. All fittings have process leakage testing for reliable products.



## Metric Size Fitting / Inch Size Fitting / Large Size Fitting

One-touch type enabling easy to attach and detach, safe use  
Cork-type allowing excellent sealing function and high durability against leakage  
Made of FDA-approved material ensuring its safety, certified as NSF 51, 61  
Food and beverage fittings with oval sleeves



### Check Valves

Non-return valve that allows fluid to flow only in one direction  
Usable for water, food and beverage  
Compact size for convenient use in confined spaces  
Easy to install and convenient to use



### Flow Control Valves

Valve that discharges constant flow by controlling small flow rate  
Usable for water, food and beverage  
Flow rate increase / decrease controller available under any spatial changes  
Securable stability under any temperature changes



### Ball Valves

Valve to open and close the supply of compressed air and water  
Usable for air and water, convenient for use in confined spaced  
Size-adjustable to fit in the hose and securable to valid cross sectional area as hose size



### Filter Strainers

Usable for water, food and beverage  
Filter out fine impurities with stainless steel filter net  
Easy filter installation and replacement



### STEELFIT

Nut and holder help two O-rings provide a stronger seal  
Allowing the use of stainless pipe or similar tube



### Cartridges

Effectively inserting and using a counterpart with a cavity in the counterpart  
Composed of half & full cartridges made of acetal and brass materials



### Accessories

Usable for water, food and beverage  
Made of FDA-approved material ensuring its safety, certified as NSF 51, 61



### Tube

Water purifier, coffee machine, food and beverage hose  
Available for various range of temperatures and pressures  
Excellent chemical durability  
Compliance with FDA standards



## Applications and Features

- Fluidfit products are designed for water, food and air contact but can be used with selected gases, vacuum & liquids
- A single action allows the tube to release and connect easily, saving time and expense
- Fluidfit products are made of NSF approved non-toxic materials
- Various uses depending on the user's environment and application

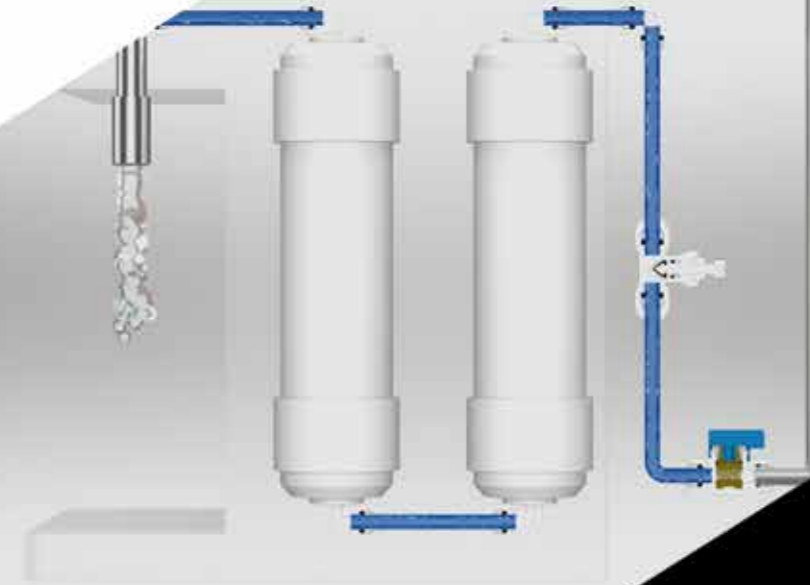
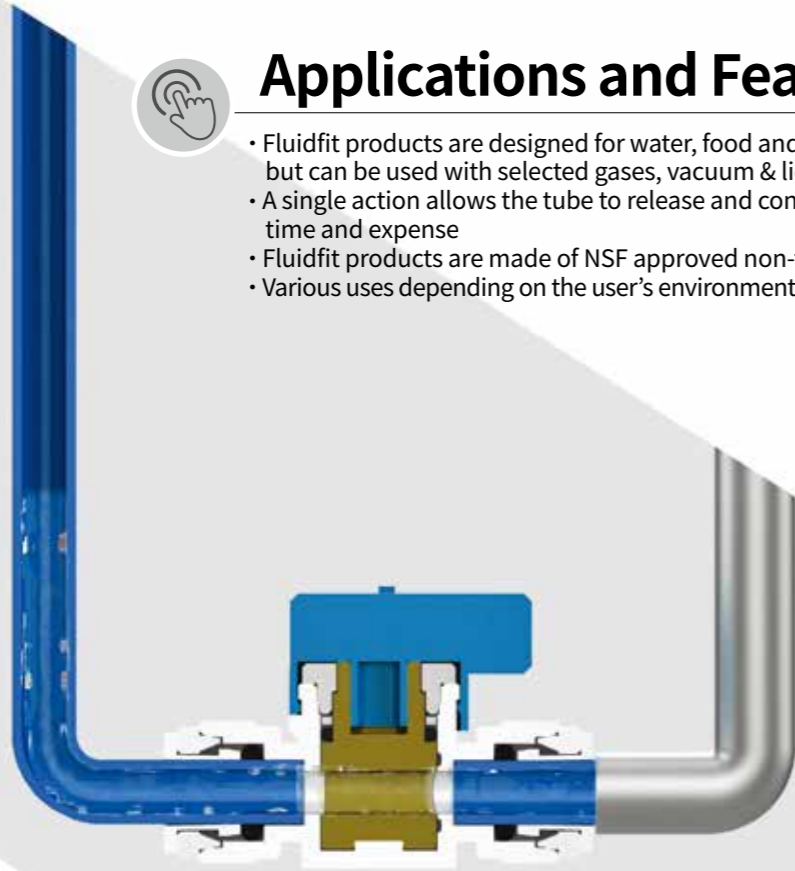

## Contents

Page

8	<b>PUSH-IN FITTINGS</b>
20	<b>SWIVEL TYPE FITTINGS</b>
22	<b>LARGE SIZE FITTINGS</b>
24	<b>SINGLE CHECK VALVES (NON-RETURN VALVE)</b>
25	<b>FLOW CONTROL VALVES</b>
26	<b>BALL VALVES (SHUT-OFF VALVE)</b>
27	<b>FILTERS</b>
28	<b>STEELFIT</b>
29	<b>CARTRIDGES</b>
30	<b>ACCESSORIES</b>
31	<b>POLYETHYLENE TUBE</b>



## PUSH-IN FITTINGS

## Structural Diagram

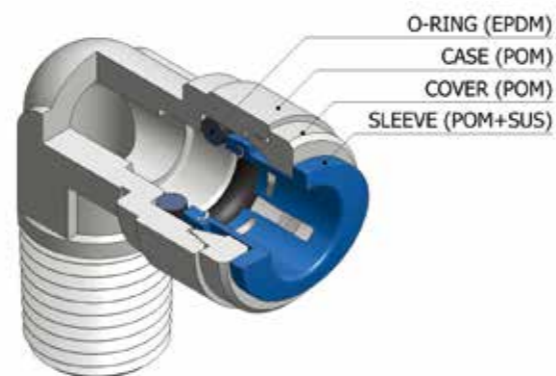

## Specifications

- Fluidfit products are designed for water, food and air contact
- Fluid type : Water, Beverages
- Working pressure : 0~230PSI / 0~16kgf/cm<sup>2</sup>
- Working temperature : 34~140° F / 0~60°C
- Applicable Tube : Polyethylene(PE), Polyamide(PA), and Polyurethane(PU)
- Reference data(next page)

Naturally high-quality,  
improved by technology.

## Product Code System

METRIC - **BSPT(R)**

**HPC 06 - R01**

FITTING FOR WATER APPLICATION	TUBE DIA		THREAD SIZE	
	CODE	SIZE	R(PT) THREAD	SIZE
	04	Ø4	R01	R1/8
	06	Ø6	R02	R1/4
	08	Ø8	R03	R3/8
	10	Ø10	R04	R1/2
	12	Ø12		

METRIC - **BSPP(G)**

**HPC 04 - G01**

FITTING FOR WATER APPLICATION	TUBE DIA		THREAD SIZE	
	CODE	SIZE	G(PF) THREAD	SIZE
	04	Ø4	G01	G1/8
	05	Ø5	G02	G1/4
	06	Ø6	G03	G3/8
	08	Ø8	G04	G1/2
	10	Ø10	G05	G5/8
	12	Ø12	G06	G3/4
	15	Ø15		
	22	Ø22		

INCH - **NPT**

**HPC 5/32 - N01**

FITTING FOR WATER APPLICATION	TUBE DIA		THREAD SIZE	
	CODE	SIZE	NPT THREAD	SIZE
	5/32	Ø5/32	N01	NPT1/8
	3/16	Ø3/16	N02	NPT1/4
	1/4	Ø1/4	N03	NPT3/8
	5/16	Ø5/16	N04	NPT1/2
	3/8	Ø3/8		
	1/2	Ø1/2		

• Maximum Torque Values for BSP, BSPT and NPT Plastic Threads

Threads	1/8"	1/4"	3/8"	1/2"	3/4"
Max. Torque	1.5Nm	1.5Nm	3.0Nm	3.0Nm	4.0Nm

## Reference data

- Fluid type : **Water, Beverages**
- Tube type : **Polyethylene(PE), Polyamide(PA) and Polyurethane(PU)**

• Working Pressure & Temperatures

∅	°C	-20°C	1°C	25°C	70°C	98°C
4mm 5/32"	0Bar→8Bar with dry air only	-750 mmHg→20 Bar	-750 mmHg→20 Bar	-750 mmHg→20 Bar	-750 mmHg→16 Bar	-750 mmHg→10 Bar
6mm 3/16"-1/4"		-750 mmHg→20 Bar	-750 mmHg→20 Bar	-750 mmHg→20 Bar	-750 mmHg→16 Bar	-750 mmHg→10 Bar
8mm 5/16"		-750 mmHg→20 Bar	-750 mmHg→20 Bar	-750 mmHg→20 Bar	-750 mmHg→16 Bar	-750 mmHg→10 Bar
10mm 3/8"		-750 mmHg→16 Bar	-750 mmHg→16 Bar	-750 mmHg→16 Bar	-750 mmHg→14 Bar	-750 mmHg→10 Bar
12mm 1/2"		-750 mmHg→14 Bar	-750 mmHg→14 Bar	-750 mmHg→14 Bar	-750 mmHg→8 Bar	-750 mmHg→6 Bar
15mm		-750 mmHg→14 Bar	-750 mmHg→14 Bar	-750 mmHg→14 Bar	-750 mmHg→8 Bar	-750 mmHg→6 Bar
22mm		-750 mmHg→14 Bar	-750 mmHg→14 Bar	-750 mmHg→14 Bar	-750 mmHg→8 Bar	-750 mmHg→6 Bar

• Temperatures and Pressures indicated refers to NSF standards limits, Please contact our technical department for higher temperature and /or pressure application needs.

• System performances always depend from fittings, tubes and possible other items and accessories used. It is a responsibility for users to cross check the technical characteristics of each single component in order to avoid possible failures and dangers.

## Connection & Disconnection

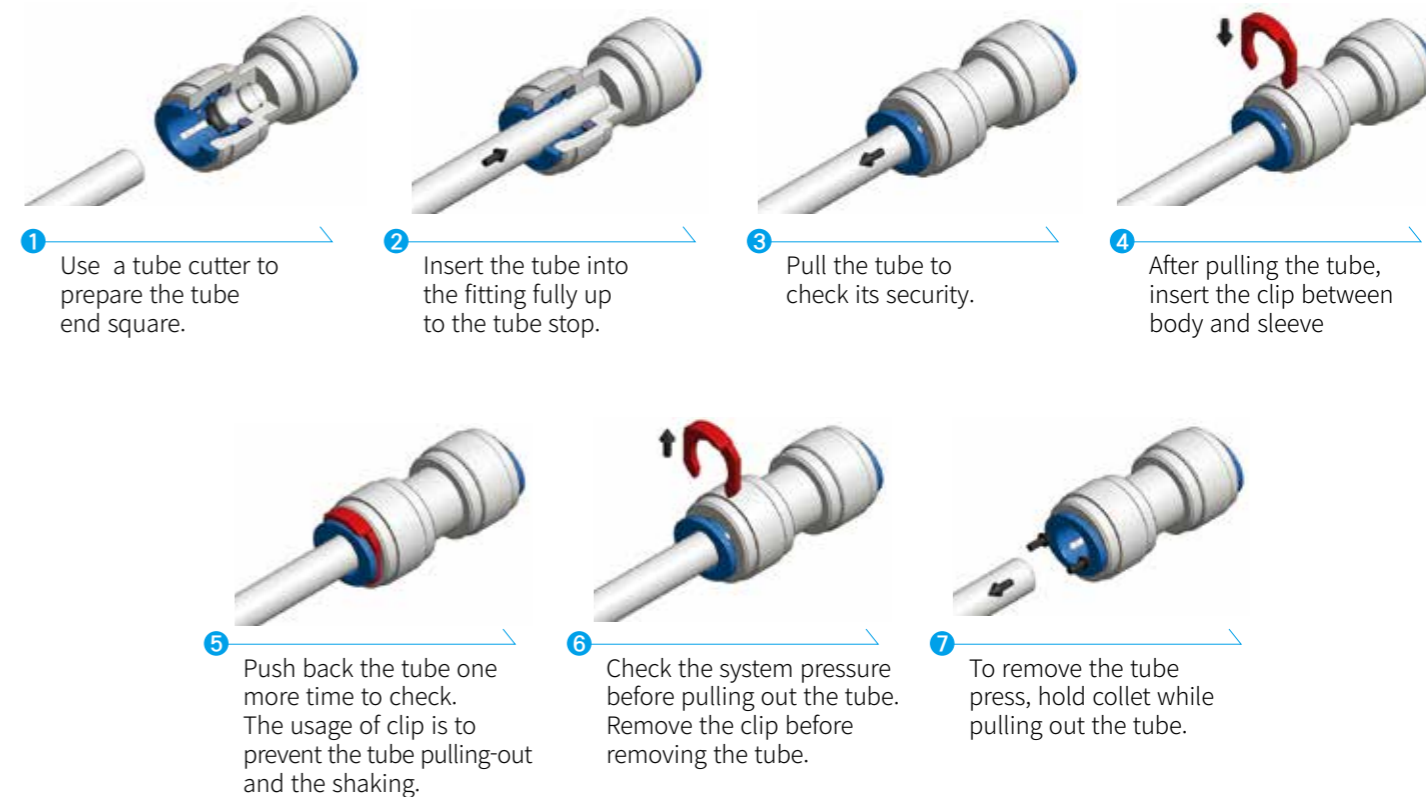

PUSH-IN FITTINGS

Fittings For Water Application  
**METRIC FITTINGS**

Metric Fitting

Male Connector

HPC



PART NO.	TUBE (Metric)	THREAD (R)	Qty/Box
HPC 04R01	04	R1/8	100
HPC 06R01	06	R1/8	100
HPC 06R02	06	R1/4	100
HPC 06R03	06	R3/8	50
HPC 08R01	08	R1/8	100
HPC 08R02	08	R1/4	50
HPC 08R03	08	R3/8	50
HPC 08R04	08	R1/2	50
HPC 10R02	10	R1/4	50
HPC 10R03	10	R3/8	50
HPC 10R04	10	R1/2	50
HPC 12R03	12	R3/8	50
HPC 12R04	12	R1/2	50

PART NO.	TUBE (Metric)	THREAD (NPT)	Qty/Box
HPC 06-N03	06	NPT3/8	50
HPC 12-N04	12	NPT1/2	50

HPC-G



PART NO.	TUBE (Metric)	THREAD (G)	Qty/Box
HPC 04G01	04	G1/8	100
HPC 04G02	04	G1/4	100
HPC 06G01	06	G1/8	100
HPC 06G02	06	G1/4	100
HPC 08G01	08	G1/8	100
HPC 08G02	08	G1/4	50
HPC 08G03	08	G3/8	50
HPC 08G04	08	G1/2	50
HPC 10G02	10	G1/4	50
HPC 10G03	10	G3/8	50
HPC 10G04	10	G1/2	25
HPC 12G03	12	G3/8	25
HPC 12G04	12	G1/2	25

Female Adapter

HCF-G



PART NO.	TUBE (Metric)	THREAD (G)	Qty/Box
HCF 04G01	04	G1/8	50
HCF 06G01	06	G1/8	50
HCF 06G02	06	G1/4	50
HCF 06G03	06	G3/8	50
HCF 08G01	08	G1/8	50
HCF 08G02	08	G1/4	50
HCF 08G03	08	G3/8	50
HCF 08G04	08	G1/2	25
HCF 10G02	10	G1/4	50
HCF 10G03	10	G3/8	25
HCF 10G04	10	G1/2	25
HCF 10G05	10	G5/8	25
HCF 12G02	12	G1/4	50
HCF 12G03	12	G3/8	25
HCF 12G04	12	G1/2	25

PART NO.	TUBE (Metric)	THREAD (UNF)	Qty/Box
HCF 06-UNF 7/16-20	06	7/16-20	50
HCF 08-UNF 7/16-20	08	7/16-20	50
HCF 10-UNF 7/16-20	10	7/16-20	50

PART NO.	TUBE (Metric)	THREAD (UNS)	Qty/Box
HCF 06-UNS 7/16-24	06	7/16-24	50
HCF 08-UNS 7/16-24	08	7/16-24	50

HCF-NH



PART NO.	TUBE (Metric)	THREAD (NH)	Qty/Box
HCF 06-NH06	06	NH 3/4	20
HCF 08-NH06	08	NH 3/4	20
HCF 10-NH06	10	NH 3/4	20

HCF-G

PART NO.	TUBE (Metric)	THREAD (G)	Qty/Box
HCF 08G06	08	G3/4	20
HCF 10G06	10	G3/4	20

Black Acetal Fittings | Black

Metric size fitting is manufactured in black acetal copolymer with food grade EPDM O-ring. They are suitable for water, liquids foods, air & gas

- One-touch type enabling easy to attach and detach, safe use
- Cork-type allowing excellent sealing function and high durability against leakage.
- Made of FDA-approved material ensuring its safety, certified as NSF 51, 61
- Food and beverage fittings with oval sleeves

**Stem Adapter**

**HCJ**



PART NO.	STEM O.D (Metric)	THREAD (R)	Qty/Box
HCJ 04R01	04	R1/8	100
HCJ 04R02	04	R1/4	100
HCJ 06R01	06	R1/8	100
HCJ 06R02	06	R1/4	100
HCJ 08R01	08	R1/8	100
HCJ 08R02	08	R1/4	50
HCJ 08R03	08	R3/8	50
HCJ 10R02	10	R1/4	50
HCJ 10R03	10	R3/8	50
HCJ 10R04	10	R1/2	25
HCJ 12R03	12	R3/8	50
HCJ 12R04	12	R1/2	25

**Stem Adapter**

**HCJ-G**



PART NO.	STEM O.D (Metric)	THREAD (G)	Qty/Box
HCJ 04G01	04	G1/8	100
HCJ 04G02	04	G1/4	100
HCJ 06G01	06	G1/8	100
HCJ 06G02	06	G1/4	100
HCJ 08G01	08	G1/8	100
HCJ 08G02	08	G1/4	50
HCJ 08G03	08	G3/8	50
HCJ 10G02	10	G1/4	50
HCJ 10G03	10	G3/8	50
HCJ 10G04	10	G1/2	25
HCJ 12G03	12	G3/8	50
HCJ 12G04	12	G1/2	25

**Male Elbow**

**HPL**



PART NO.	TUBE (Metric)	THREAD (R)	Qty/Box
HPL 04R01	04	R1/8	100
HPL 04R02	04	R1/4	50
HPL 06R01	06	R1/8	100
HPL 06R02	06	R1/4	50
HPL 06R03	06	R3/8	50
HPL 08R02	08	R1/4	50
HPL 08R03	08	R3/8	50
HPL 10R02	10	R1/4	50
HPL 10R03	10	R3/8	50
HPL 12R02	12	R1/4	25
HPL 12R03	12	R3/8	25
HPL 12R04	12	R1/2	25

PART NO.	TUBE (Metric)	THREAD (NPT)	Qty/Box
HPL 06-N01	06	NPT1/8	100
HPL 06-N02	06	NPT1/4	50
HPL 06-N03	06	NPT3/8	50
HPL 12-N04	12	NPT1/2	25

**Stem Elbow**

**HLJ**



PART NO.	STEM O.D (Metric)	TUBE (Metric)	Qty/Box
HLJ 04-04	04	04	100
HLJ 06-06	06	06	100
HLJ 06-08	06	08	100
HLJ 08-08	08	08	50
HLJ 10-06	10	06	50
HLJ 10-08	10	08	50
HLJ 10-10	10	10	50
HLJ 12-12	12	12	25

**Stem Reducer**

**HGJ**



PART NO.	STEM O.D (Metric)	TUBE (Metric)	Qty/Box
HGJ 04-05	04	05	100
HGJ 06-04	06	04	100
HGJ 08-04	08	04	100
HGJ 08-06	08	06	50
HGJ 08-08	08	08	50
HGJ 08-10	08	10	50
HGJ 10-06	10	06	50
HGJ 10-08	10	08	50
HGJ 12-08	12	08	25
HGJ 12-10	12	10	25

**Bulkhead Connector**

**HMM**



PART NO.	TUBE (Metric)	TUBE (Metric)	Qty/Box
HMM 04-04	04	04	50
HMM 06-04	06	04	50
HMM 06-06	06	06	50
HMM 08-06	08	06	25
HMM 08-08	08	08	25
HMM 10-10	10	10	25
HMM 12-12	12	12	20

PART NO.	TUBE (Metric)	TUBE (Inch)	Qty/Box
HMM 06-1/4	06	1/4	50

**Union Connector**

**HUC**



PART NO.	TUBE (Metric)	TUBE (Metric)	Qty/Box
HUC 0404	04	04	100
HUC 0604	06	04	100
HUC 0605	06	05	100
HUC 0606	06	06	100
HUC 0804	08	04	50
HUC 0806	08	06	50
HUC 0808	08	08	50
HUC 1006	10	06	50
HUC 1008	10	08	50
HUC 1010	10	10	50
HUC 1208	12	08	25
HUC 1210	12	10	25
HUC 1212	12	12	25

**Union Elbow**

**HUL**



PART NO.	TUBE (Metric)	TUBE (Metric)	Qty/Box
HUL 0404	04	04	100
HUL 0604	06	04	100
HUL 0606	06	06	100
HUL 0804	08	04	50
HUL 0806	08	06	50
HUL 0808	08	08	50
HUL 1006	10	06	50
HUL 1008	10	08	50
HUL 1010	10	10	50
HUL 1206	12	06	25
HUL 1208	12	08	25
HUL 1210	12	10	25
HUL 1212	12	12	25

PART NO.	TUBE (Inch)	TUBE (Metric)	Qty/Box
HUL 1/4-06	1/4	06	100

**Union Tee**

**HUT**



PART NO.	TUBE (Metric)	TUBE (Metric)	Qty/Box
HUT 0404	04	04	100
HUT 0606	06	06	50
HUT 0808	08	08	50
HUT 1010	10	10	25
HUT 1212	12	12	20

PART NO.	TUBE (Metric)	TUBE (Metric)	TUBE (Metric)	Qty/Box
HUT 100608	10	06	08	25
HUT 100610	10	06	10	25
HUT 121012	12	10	12	20

**Two Way Divider**

**HUY**



PART NO.	TUBE (Metric)	TUBE (Metric)	Qty/Box
HUY 0404	04	04	100
HUY 0606	06	06	50
HUY 0808	08	08	50
HUY 1008	10	08	25
HUY 1010	10	10	25
HUY 1212	12	12	20

**Female Plug**

**HPF**



PART NO.	TUBE (Metric)	Qty/Box
HPF 04	04	100
HPF 06	06	100
HPF 08	08	100
HPF 10	10	100
HPF 12	12	50

**Male Plug**

**HPP**



PART NO.	STEM O.D (Metric)	Qty/Box
HPP 04	04	200
HPP 06	06	200
HPP 08	08	100
HPP 10	10	100
HPP 12	12	100

**Branch Stem Tee**

**HSJ**



PART NO.	STEM O.D (Metric)	TUBE (Metric)	Qty/Box
HSJ 0404	04	04	100
HSJ 0606	06	06	50
HSJ 0808	08	08	50
HSJ 1010	10	10	25
HSJ 1212	12	12	20

**Union Cross**

**HZA**



PART NO.	TUBE (Metric)	TUBE (Metric)	Qty/Box
HZA 0606	06	06	25
HZA 0808	08	08	20
HZA 1010	10	10	20

**Barb Connector**

**HCBB**



PART NO.	TUBE (Metric)	Stem I.D (Metric)	Qty/Box
HCBB 1210	12	10	25

**Stem Tee**

**HTJ**



PART NO.	STEM O.D (Metric)	TUBE (Metric)	Qty/Box
HTJ 0808	08	08	25

**Offset Connector**

**HUGL**



PART NO.	TUBE (Metric)	TUBE (Metric)	Qty/Box
HUGL 1208	12	08	25

**Stem Barb Connector**

**HCJB**



PART NO.	STEM O.D (Metric)	TUBE I.D (Metric)	Qty/Box
HCJB 0604	06	04	100
HCJB 0606	06	06	100
HCJB 0806	08	06	100
HCJB 1006	10	06	100
HCJB 1008	10	08	100
HCJB 1010	10	10	100
HCJB 1210	12	12	100

**Stem Barb Elbow Connector**

**HLJB**



PART NO.	STEM O.D (Metric)	TUBE I.D (Metric)	Qty/Box
HLJB 1006	10	06	100
HLJB 1008	10	08	100

Fittings For Water Application  
**INCH FITTINGS**

## PUSH-IN FITTINGS

Inch Fitting

### Male Connector

#### HPC

PART NO.	TUBE (Inch)	THREAD (NPT)	Qty/Box
HPC 5/32-N01	5/32	NPT1/8	100
HPC 5/32-N02	5/32	NPT1/4	100
HPC 3/16-N01	3/16	NPT1/8	100
HPC 3/16-N02	3/16	NPT1/4	100
HPC 1/4-N01	1/4	NPT1/8	100
HPC 1/4-N02	1/4	NPT1/4	100
HPC 1/4-N03	1/4	NPT3/8	50
HPC 1/4-N04	1/4	NPT1/2	50
HPC 5/16-N01	5/16	NPT1/8	50
HPC 5/16-N02	5/16	NPT1/4	50
HPC 5/16-N03	5/16	NPT3/8	50
HPC 5/16-N04	5/16	NPT1/2	50
HPC 3/8-N01	3/8	NPT1/8	50
HPC 3/8-N02	3/8	NPT1/4	50
HPC 3/8-N03	3/8	NPT3/8	50
HPC 3/8-N04	3/8	NPT1/2	50
HPC 1/2-N03	1/2	NPT3/8	50
HPC 1/2-N04	1/2	NPT1/2	25



PART NO.	TUBE (Inch)	THREAD (R)	Qty/Box
HPC 1/4-R01	1/4	R1/8	100
HPC 1/4-R02	1/4	R1/4	100
HPC 1/4-R03	1/4	R3/8	50
HPC 3/8-R02	3/8	R1/4	50
HPC 3/8-R03	3/8	R3/8	50
HPC 1/2-R03	1/2	R3/8	50
HPC 1/2-R04	1/2	R1/2	25

PART NO.	TUBE (Inch)	THREAD (G)	Qty/Box
HPC 3/16-G01	3/16	G1/8	100
HPC 1/4-G01	1/4	G1/8	100
HPC 1/4-G02	1/4	G1/4	100
HPC 5/16-G01	5/16	G1/8	100
HPC 5/16-G02	5/16	G1/4	50
HPC 5/16-G03	5/16	G3/8	50
HPC 3/8-G01	3/8	G1/8	50
HPC 3/8-G02	3/8	G1/4	50
HPC 3/8-G03	3/8	G3/8	50
HPC 1/2-G03	1/2	G3/8	25
HPC 1/2-G04	1/2	G1/2	25



#### HPC-MFL

PART NO.	TUBE (Inch)	THREAD (MFL)	Qty/Box
HPC 3/8-MFL02	3/8	MFL1/4	50



\*MFL02 Corresponds to a UNF 7/16-20

### Female Adapter

#### HCF

PART NO.	TUBE (Inch)	THREAD (NPT)	Qty/Box
HCF 1/4-N01	1/4	NPT1/8	50
HCF 1/4-N02	1/4	NPT1/4	50
HCF 5/16-N02	5/16	NPT1/4	50
HCF 3/8-N02	3/8	NPT1/4	50



PART NO.	TUBE (Inch)	THREAD (G)	Qty/Box
HCF 1/4-G03	1/4	G3/8	50
HCF 1/4-G04	1/4	G1/2	25
HCF 5/16-G04H	5/16	G1/2	50
HCF 5/16-G05H	5/16	G5/8	25
HCF 3/8-G03	3/8	G3/8	25
HCF 3/8-G04	3/8	G1/2	25
HCF 3/8-G04H	3/8	G1/2	25
HCF 3/8-G05	3/8	G5/8	25
HCF 3/8-G05H	3/8	G5/8	25
HCF 1/2-G04	1/2	G1/2	25

PART NO.	TUBE (Inch)	THREAD (UNF)	Qty/Box
HCF 5/16-UNF7/16-20	5/16	7/16-20	50
HCF 1/4-UNF7/16-20	1/4	7/16-20	50
HCF 3/8-UNF7/16-20	3/8	7/16-20	50

PART NO.	TUBE (Inch)	THREAD (UN)	Qty/Box
HCF 3/8-UN1/2-16	3/8	1/2-16	50
HCF 1/2-UN1/2-16	1/2	1/2-16	25

PART NO.	TUBE (Inch)	THREAD (UNS)	Qty/Box
HCF 5/16-UNS7/16-24	5/16	7/16-24	50
HCF 1/4-UNS7/16-24	1/4	7/16-24	50
HCF 3/8-UNS7/16-24	3/8	7/16-24	50

#### HCF-NH

PART NO.	TUBE (Inch)	THREAD (NH)	Qty/Box
HCF 1/4-NH06	1/4	NH3/4	20
HCF 5/16-NH06	5/16	NH3/4	20
HCF 3/8-NH06	3/8	NH3/4	20



#### HCF-G

PART NO.	TUBE (Inch)	THREAD (G)	Qty/Box
HCF 1/4-G06	1/4	G3/4	20
HCF 3/8-G06	3/8	G3/4	20

## Gray Acetal Fittings | Gray

Inch size fitting is manufactured of gray acetal copolymer with food grade EPDM O-ring. They are suitable for water, liquids foods, and air & gas

## White Acetal Fittings | White

Both sizes (metric & inch) are manufactured of white acetal copolymer with food grade EPDM O-ring. They are suitable for water, liquids foods, and air & gas



### Stem Adapter

#### HCJ



PART NO.	STEM O.D (Inch)	THREAD (NPT)	Qty/Box
HCJ 5/32-N01	5/32	NPT1/8	100
HCJ 5/32-N02	5/32	NPT1/4	100
HCJ 3/16-N01	3/16	NPT1/8	100
HCJ 1/4-N01	1/4	NPT1/8	100
HCJ 1/4-N02	1/4	NPT1/4	100
HCJ 5/16-N01	5/16	NPT1/8	100
HCJ 5/16-N02	5/16	NPT1/4	50
HCJ 5/16-N03	5/16	NPT3/8	50
HCJ 3/8-N02	3/8	NPT1/4	50
HCJ 3/8-N03	3/8	NPT3/8	50
HCJ 1/2-N03	1/2	NPT3/8	50
HCJ 1/2-N04	1/2	NPT1/2	25

### Male Elbow

#### HPL



PART NO.	TUBE (Inch)	THREAD (NPT)	Qty/Box
HPL 5/32-N01	5/32	NPT1/8	100
HPL 3/16-N01	3/16	NPT1/8	100
HPL 1/4-N01	1/4	NPT1/8	100
HPL 1/4-N02	1/4	NPT1/4	50
HPL 1/4-N03	1/4	NPT3/8	50
HPL 5/16-N02	5/16	NPT1/4	50
HPL 5/16-N03	5/16	NPT3/8	50
HPL 3/8-N02	3/8	NPT1/4	50
HPL 3/8-N03	3/8	NPT3/8	50
HPL 1/2-N03	1/2	NPT3/8	25
HPL 1/2-N04	1/2	NPT1/2	25

PART NO.	TUBE (Inch)	THREAD (R)	Qty/Box
HPL 3/8-R03	3/8	R3/8	50

### Stem Elbow

#### HLJ



PART NO.	STEM O.D (Inch)	TUBE (Inch)	Qty/Box
HLJ 5/32-5/32	5/32	5/32	100
HLJ 3/16-3/16	3/16	3/16	100
HLJ 1/4-1/4	1/4	1/4	100
HLJ 1/4-5/16	1/4	5/16	50
HLJ 5/16-5/16	5/16	5/16	50
HLJ 3/8-1/4	3/8	1/4	50
HLJ 3/8-5/16	3/8	5/16	50
HLJ 3/8-3/8	3/8	3/8	50
HLJ 1/2-1/2	1/2	1/2	25

PART NO.	TUBE (Inch)	TUBE (Metric)	Qty/Box
HLJ 1/4-06	1/4	06	100
HLJ 3/8-06	3/8	06	50

### Stem Reducer

#### HGJ



PART NO.	STEM O.D (Inch)	TUBE (Inch)	Qty/Box
HGJ 1/4-5/32	1/4	5/32	100
HGJ 5/16-1/4	5/16	1/4	100
HGJ 5/16-3/8	5/16	3/8	50
HGJ 5/16-5/16	5/16	5/16	50
HGJ 3/8-3/16	3/8	3/16	50
HGJ 3/8-1/4	3/8	1/4	50
HGJ 3/8-5/16	3/8	5/16	50
HGJ 3/8-1/2	3/8	1/2	50
HGJ 1/2-5/16	1/2	5/16	50
HGJ 1/2-3/8	1/2	3/8	50
HGJ 1/2-15	1/2	15	20

### Bulkhead Connector

#### HMM



PART NO.	TUBE (Inch)	TUBE (Inch)	Qty/Box
HMM 5/32-5/32	5/32	5/32	50
HMM 1/4-1/4	1/4	1/4	50
HMM 1/4-3/8	1/4	3/8	25
HMM 5/16-5/16	5/16	5/16	25
HMM 3/8-3/8	3/8	3/8	25
HMM 1/2-1/2	1/2	1/2	20

PART NO.	TUBE (Inch)	TUBE (Metric)	Qty/Box
HMM 1/4-06	1/4	06	06

### Union Connector

#### HUC



PART NO.	TUBE (Inch)	TUBE (Inch)	Qty/Box
HUC 5/32-5/32	5/32	5/32	100
HUC 3/16-3/16	3/16	3/16	100
HUC 1/4-1/4	1/4	1/4	100
HUC 5/16-5/32	5/16	5/32	50
HUC 5/16-1/4	5/16	1/4	50
HUC 5/16-5/16	5/16	5/16	50
HUC 3/8-3/16	3/8	3/16	50
HUC 3/8-1/4	3/8	1/4	50
HUC 3/8-5/16	3/8	5/16	50
HUC 3/8-3/8	3/8	3/8	50
HUC 1/2-5/16	1/2	5/16	25
HUC 1/2-3/8	1/2	3/8	25
HUC 1/2-1/2	1/2	1/2	25

PART NO.	TUBE (Inch)	TUBE (Metric)	Qty/Box
HUC 1/4-06	1/4	06	100

### Union Elbow

#### HUL



PART NO.	TUBE (Inch)	TUBE (Inch)	Qty/Box
HUL 5/32-5/32	5/32	5/32	100
HUL 3/16-3/16	3/16	3/16	100
HUL 1/4-1/4	1/4	1/4	100
HUL 5/16-5/32	5/16	5/32	50
HUL 5/16-1/4	5/16	1/4	50
HUL 5/16-5/16	5/16	5/16	50
HUL 3/8-1/4	3/8	1/4	50
HUL 3/8-5/16	3/8	5/16	50
HUL 3/8-3/8	3/8	3/8	50
HUL 1/2-5/16	1/2	5/16	25
HUL 1/2-3/8	1/2	3/8	25
HUL 1/2-1/2	1/2	1/2	25

### Union Tee

#### HUT



PART NO.	TUBE (Inch)	TUBE (Inch)	Qty/Box
HUT 5/32-5/32	5/32	5/32	100
HUT 3/16-3/16	3/16	3/16	50
HUT 1/4-1/4	1/4	1/4	50
HUT 5/16-5/16	5/16	5/16	50
HUT 3/8-3/8	3/8	3/8	25
HUT 1/2-1/2	1/2	1/2	20

PART NO.	TUBE (Inch)	TUBE (Inch)	TUBE (Inch)	Qty/Box
HUT 3/8-1/4-3/8	3/8	1/4	3/8	25
HUT 1/2-3/8-1/2	1/2	3/8	1/2	25

PART NO.	TUBE (Inch)	TUBE (Metric)	TUBE (Inch)	Qty/Box
HUT 3/8-10-3/8	3/8	10	3/8	25
HUT 3/8-08-3/8	3/8	08	3/8	25

### Two Way Divider

#### HUY



PART NO.	TUBE (Inch)	TUBE (Inch)	Qty/Box
HUY 5/32-5/32	5/32	5/32	100
HUY 3/16-3/16	3/16	3/16	50
HUY 1/4-1/4	1/4	1/4	50
HUY 5/16-5/16	5/16	5/16	50
HUY 3/8-3/8	3/8	3/8	25
HUY 1/2-1/2	1/2	1/2	20

### Female Plug

#### HPF



PART NO.	TUBE (Inch)	Qty/Box
HPF 5/32	5/32	100
HPF 3/16	3/16	100
HPF 1/4	1/4	100
HPF 5/16	5/16	100
HPF 3/8	3/8	100
HPF 1/2	1/2	50

# PUSH-IN FITTINGS

Inch Fitting

## Male Plug

### HPP



PART NO.	STEM O.D (Inch)	Qty/Box
HPP 5/32	5/32	200
HPP 3/16	3/16	200
HPP 1/4	1/4	200
HPP 5/16	5/16	100
HPP 3/8	3/8	100
HPP 1/2	1/2	100

## Branch Stem Tee

### HSJ



PART NO.	STEM O.D (Inch)	TUBE (Inch)	Qty/Box
HSJ 5/32-5/32	5/32	5/32	100
HSJ 1/4-1/4	1/4	1/4	50
HSJ 5/16-5/16	5/16	5/16	50
HSJ 3/8-3/8	3/8	3/8	25
HSJ 1/2-1/2	1/2	1/2	20

PART NO.	STEM O.D (Inch)	TUBE (Inch)	TUBE (Inch)	Qty/Box
HSJ 1/2-3/8-1/2	1/2	3/8	1/2	20

## Union Cross

### HZA



PART NO.	STEM O.D (Inch)	TUBE (Inch)	Qty/Box
HZA 1/4-1/4	1/4	1/4	50
HZA 5/16-5/16	5/16	5/16	20
HZA 3/8-3/8	3/8	3/8	20

## Stem Tee

### HTJ



PART NO.	STEM O.D (Inch)	TUBE (Inch)	Qty/Box
HTJ 1/4-1/4	1/4	1/4	50
HTJ 5/16-5/16	5/16	5/16	25
HTJ 3/8-3/8	3/8	3/8	25

## Cooling Mainfold

### HUTT



PART NO.	TUBE (Metric)	TUBE (Inch)	TUBE (Metric)	Qty/Bag
HUTT 15-3/8-15	15	3/8	15	20

Bulk packaging

PART NO.	TUBE (Metric)	TUBE (Inch)	TUBE (Metric)	Qty/Bag
HUTT 1/2-3/8-1/2	1/2	3/8	1/2	20

Bulk packaging

## F/F Reducer

### HUFF



PART NO.	THREAD (G)	THREAD (G)	Qty/Bag
HUFF G02-G06	G1/4	G3/4	100
HUFF G03-G06	G3/8	G3/4	100

Bulk packaging

# PUSH-IN FITTINGS

Inch Fitting

## Stem Barb Connector

### HCJB



PART NO.	STEM O.D (Inch)	TUBE I.D (Inch)	Qty/Box
HCJB 1/4-3/16	1/4	3/16	100
HCJB 1/4-1/4	1/4	1/4	100
HCJB 5/16-5/16	5/16	5/16	100
HCJB 5/16-3/16	5/16	3/16	100
HCJB 5/16-3/8	5/16	3/8	100
HCJB 3/8-1/4	3/8	1/4	100
HCJB 3/8-5/16	3/8	5/16	100
HCJB 3/8-3/8	3/8	3/8	100
HCJB 3/8-1/2	3/8	1/2	50
HCJB 1/2-3/8	1/2	3/8	50
HCJB 1/2-1/2	1/2	1/2	50

## Stem Barb Elbow Connector

### HLJB



PART NO.	STEM O.D (Inch)	TUBE I.D (Inch)	Qty/Box
HLJB 3/8-5/16	3/8	5/16	100
HLJB 3/8-3/8	3/8	3/8	100

## U-Band

### HBU



PART NO.	TUBE (Inch)	TUBE (Inch)	Qty/Box
HBU 3/8-3/8	3/8	3/8	25
HBU 1/2-1/2	1/2	1/2	20

## Stem U-Bend

### HBUJ



PART NO.	TUBE (Inch)	Qty/Box
HBUJ 3/8	3/8	15

## Three Way Divider

### HTWD



PART NO.	TUBE (Inch)	TUBE (Inch)	Qty/Bag
HTWD 1/2-3/8	1/2	3/8	20
HTWD 1/2-1/2	1/2	1/2	20

Bulk packaging

# SWIVEL TYPE FITTINGS

Fluidfit

## Swivel Male Elbow

HRPL	PART NO.	TUBE (Metric)	THREAD (R)	Qty/Box
	HRPL 04R01	04	R1/8	50
	HRPL 04R02	04	R1/4	50
	HRPL 06R01	06	R1/8	50
	HRPL 06R02	06	R1/4	50
	HRPL 08R01	08	R1/8	25
	HRPL 08R02	08	R1/4	25
	HRPL 08R03	08	R3/8	25
	HRPL 10R02	10	R1/4	25
	HRPL 10R03	10	R3/8	25
	HRPL 10R04	10	R1/2	20
	HRPL 12R03	12	R3/8	20
	HRPL 12R04	12	R1/2	20

## Swivel Male Run Tee

HRST	PART NO.	TUBE (Metric)	THREAD (R)	Qty/Box
	HRST 04R01	04	R1/8	50
	HRST 04R02	04	R1/4	50
	HRST 06R01	06	R1/8	50
	HRST 06R02	06	R1/4	25
	HRST 08R01	08	R1/8	25
	HRST 08R02	08	R1/4	25
	HRST 08R03	08	R3/8	25
	HRST 10R02	10	R1/4	25
	HRST 10R03	10	R3/8	20
	HRST 10R04	10	R1/2	20
	HRST 12R03	12	R3/8	15
	HRST 12R04	12	R1/2	12

# SWIVEL TYPE FITTINGS

Inch Fitting

## Swivel Male Elbow

HRPL	PART NO.	TUBE (Inch)	THREAD (NPT)	Qty/Box
	HRPL 5/32-N01	5/32	NPT1/8	50
	HRPL 5/32-N02	5/32	NPT1/4	50
	HRPL 1/4-N01	1/4	NPT1/8	50
	HRPL 1/4-N02	1/4	NPT1/4	50
	HRPL 5/16-N01	5/16	NPT1/8	25
	HRPL 5/16-N02	5/16	NPT1/4	25
	HRPL 5/16-N03	5/16	NPT3/8	25
	HRPL 3/8-N02	3/8	NPT1/4	25
	HRPL 3/8-N03	3/8	NPT3/8	25
	HRPL 1/2-N03	1/2	NPT3/8	20
	HRPL 1/2-N04	1/2	NPT1/2	20

## Swivel Male Run Tee

HRST	PART NO.	TUBE (Inch)	THREAD (NPT)	Qty/Box
	HRST 5/32-N01	5/32	NPT1/8	50
	HRST 5/32-N02	5/32	NPT1/4	50
	HRST 1/4-N01	1/4	NPT1/8	50
	HRST 1/4-N02	1/4	NPT1/4	25
	HRST 5/16-N01	5/16	NPT1/8	25
	HRST 5/16-N02	5/16	NPT1/4	25
	HRST 5/16-N03	5/16	NPT3/8	25
	HRST 3/8-N02	3/8	NPT1/4	25
	HRST 3/8-N03	3/8	NPT3/8	20
	HRST 1/2-N03	1/2	NPT3/8	15
	HRST 1/2-N04	1/2	NPT1/2	12

HRPL-G	PART NO.	TUBE (Metric)	THREAD (G)	Qty/Box
	HRPL 04G01	04	G1/8	50
	HRPL 04G02	04	G1/4	50
	HRPL 06G01	06	G1/8	50
	HRPL 06G02	06	G1/4	50
	HRPL 08G01	08	G1/8	25
	HRPL 08G02	08	G1/4	25
	HRPL 08G03	08	G3/8	25
	HRPL 10G02	10	G1/4	25
	HRPL 10G03	10	G3/8	25
	HRPL 10G04	10	G1/2	20
	HRPL 12G03	12	G3/8	20
	HRPL 12G04	12	G1/2	20

HRST-G	PART NO.	TUBE (Metric)	THREAD (G)	Qty/Box
	HRST 04G01	04	G1/8	50
	HRST 04G02	04	G1/4	50
	HRST 06G01	06	G1/8	50
	HRST 06G02	06	G1/4	25
	HRST 08G01	08	G1/8	25
	HRST 08G02	08	G1/4	25
	HRST 08G03	08	G3/8	25
	HRST 10G02	10	G1/4	25
	HRST 10G03	10	G3/8	20
	HRST 10G04	10	G1/2	20
	HRST 12G03	12	G3/8	15
	HRST 12G04	12	G1/2	12

## Swivel Male Branch Tee

HRPT	PART NO.	TUBE (Inch)	THREAD (NPT)	Qty/Box
	HRPT 5/32-N01	5/32	NPT1/8	50
	HRPT 5/32-N02	5/32	NPT1/4	50
	HRPT 1/4-N01	1/4	NPT1/8	50
	HRPT 1/4-N02	1/4	NPT1/4	25
	HRPT 5/16-N01	5/16	NPT1/8	25
	HRPT 5/16-N02	5/16	NPT1/4	25
	HRPT 5/16-N03	5/16	NPT3/8	25
	HRPT 3/8-N02	3/8	NPT1/4	25
	HRPT 3/8-N03	3/8	NPT3/8	20
	HRPT 1/2-N03	1/2	NPT3/8	15
	HRPT 1/2-N04	1/2	NPT1/2	12

## Swivel Male Y

HRWT	PART NO.	TUBE (Inch)	THREAD (NPT)	Qty/Box
	HRWT 5/32-N01	5/32	NPT1/8	50
	HRWT 5/32-N02	5/32	NPT1/4	50
	HRWT 1/4-N01	1/4	NPT1/8	50
	HRWT 1/4-N02	1/4	NPT1/4	25
	HRWT 5/16-N01	5/16	NPT1/8	25
	HRWT 5/16-N02	5/16	NPT1/4	25
	HRWT 5/16-N03	5/16	NPT3/8	25
	HRWT 3/8-N02	3/8	NPT1/4	25
	HRWT 3/8-N03	3/8	NPT3/8	25
	HRWT 1/2-N03	1/2	NPT3/8	15
	HRWT 1/2-N04	1/2	NPT1/2	12

## Swivel Male Branch Tee

HRPT	PART NO.	TUBE (Metric)	THREAD (R)	Qty/Box
	HRPT 04R01	04	R1/8	50
	HRPT 04R02	04	R1/4	50
	HRPT 06R01	06	R1/8	50
	HRPT 06R02	06	R1/4	25
	HRPT 08R01	08	R1/8	25
	HRPT 08R02	08	R1/4	25
	HRPT 08R03	08	R3/8	25
	HRPT 10R02	10	R1/4	25
	HRPT 10R03	10	R3/8	20
	HRPT 10R04	10	R1/2	20
	HRPT 12R03	12	R3/8	15
	HRPT 12R04	12	R1/2	12

## Swivel Male Y

HRWT	PART NO.	TUBE (Metric)	THREAD (R)	Qty/Box
	HRWT 04R01	04	R1/8	50
	HRWT 04R02	04	R1/4	50
	HRWT 06R01	06	R1/8	50
	HRWT 06R02	06	R1/4	25
	HRWT 08R01	08	R1/8	25
	HRWT 08R02	08	R1/4	25
	HRWT 08R03	08	R3/8	25
	HRWT 10R02	10	R1/4	25
	HRWT 10R03	10	R3/8	25
	HRWT 10R04	10	R1/2	20
	HRWT 12R03	12	R3/8	15
	HRWT 12R04	12	R1/2	12

HRPT-G	PART NO.	TUBE (Metric)	THREAD (G)	Qty/Box
	HRPT 04G01	04	G1/8	50
	HRPT 04G02	04	G1/4	50
	HRPT 06G01	06	G1/8	50
	HRPT 06G02	06	G1/4	25
	HRPT 08G01	08	G1/8	25
	HRPT 08G02	08	G1/4	25
	HRPT 08G03	08	G3/8	25
	HRPT 10G02	10	G1/4	25
	HRPT 10G03	10	G3/8	20
	HRPT 10G04	10	G1/2	20
	HRPT 12G03	12	G3/8	15
	HRPT 12G04	12	G1/2	12

HRWT-G	PART NO.	TUBE (Metric)	THREAD (G)	Qty/Box
	HRWT 04G01	04	G1/8	50
	HRWT 04G02	04	G1/4	50
	HRWT 06G01	06	G1/8	50
	HRWT 06G02	06	G1/4	25
	HRWT 08G01	08	G1/8	25
	HRWT 08G02	08	G1/4	25
	HRWT 08G03	08	G3/8	25
	HRWT 10G02	10	G1/4	25
	HRWT 10G03	10	G3/8	25
	HRWT 10G04	10	G1/2	20
	HRWT 12G03	12	G3/8	15
	HRWT 12G04	12	G1/2	12

## Adaptability

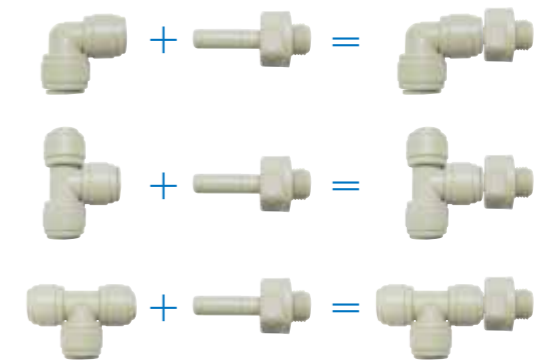

## Color Codes

HUT 0606 - B	HUT 0606 - G	HUT 0606 - W
B(Black)	G(Gray)	W(Natural)



# LARGE SIZE FITTINGS

Fluidfit



Fittings for Water Application

## Large Size Fitting

- One-touch type enabling easy to attach and detach, safe use
- Cork-type allowing excellent sealing function and high durability against leakage
- FDA-approved material ensuring its safety, certified as NSF 51, 61
- Food and beverage fittings with oval sleeves

# LARGE SIZE FITTINGS

Metric Fitting

### Male Connector

**HPC-G**

PART NO.	TUBE (Metric)	THREAD (G)	Qty/Bag
HPC 15G04	15	G1/2	20
HPC 15G06	15	G3/4	20
HPC 22G06	22	G3/4	20



### Female Adapter

**HCF-G**

PART NO.	TUBE (Metric)	THREAD (G)	Qty/Bag
HCF 15G04	15	G1/2	25
HCF 15G06	15	G3/4	20



### Stem Adapter

**HCJ-G**

PART NO.	STEM O.D (Metric)	THREAD (G)	Qty/Bag
HCJ 15G03	15	G3/8	25
HCJ 15G04	15	G1/2	25
HCJ 22G04	22	G1/2	20
HCJ 22G06	22	G3/4	20



### Stem Elbow

**HLJ**

PART NO.	STEM O.D (Metric)	TUBE (Metric)	Qty/Bag
HLJ 1515	15	15	20
HLJ 2222	22	22	20



### Stem Adapter

**HGJ**

PART NO.	STEM O.D (Metric)	TUBE (Metric)	Qty/Bag
HGJ 15-10	15	10	25
HGJ 15-12	15	12	25
HGJ 22-15	22	15	20



### Union Connector

**HUC**

PART NO.	TUBE (Metric)	TUBE (Metric)	Qty/Bag
HUC 1515	15	15	20
HUC 2222	22	22	9



### Union Elbow

**HUL**

PART NO.	TUBE (Metric)	TUBE (Metric)	Qty/Bag
HUL 1515	15	15	20
HUL 2222	22	22	9



### Union Tee

**HUT**

PART NO.	TUBE(M) ØD1	TUBE(M) ØD2	Qty/Bag
HUT 151515	15	15	9
HUT 221222	22	12	6
HUT 221522	22	15	6
HUT 222222	22	22	6



### Female Plug

**HPF**

PART NO.	TUBE(Metric)	Qty/Bag
HPF 15	15	50
HPF 22	22	20



### Male Plug

**HPP**

PART NO.	STEM O.D (Metric)	Qty/Bag
HPP 15	15	50
HPP 22	22	25



### Barb Connector

**HCBB**

PART NO.	TUBE (Metric)	STEM I.D (Inch)	Qty/Bag
HCBB 15-1/2	15	1/2	20
HCBB 22-1/2	22	1/2	20
HCBB 22-3/4	22	3/4	20



# SINGLE CHECK VALVES

(NON-RETURN VALVE)

## Structural Diagram

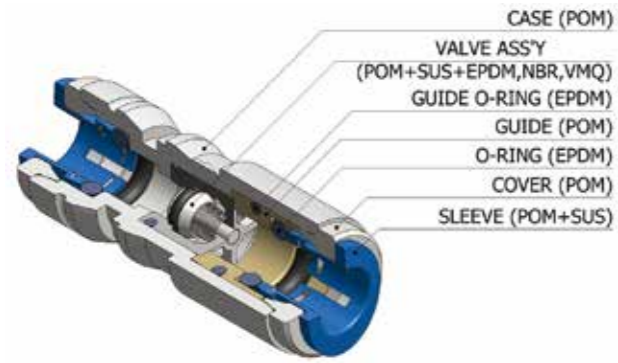

## Applications

- This Valve allows one way fluid flow and blocks the reverse flow

## Features

- Compact size and convenient to use in a narrow space
- Cracking Pressure 0.02~0.04bar
- Quick Installation and easy maintenance

### • Working Pressure & Temperatures

°C	φ	5/32 ~ 1/2	4mm~12mm
25°C		10Bar	10Bar
65°C		7Bar	7Bar

### Metric Fitting

HCVU	PART NO.	TUBE (Metric)	TUBE (Metric)	Qty/Box
	HCVU 0404	04	04	50
	HCVU 0606	06	06	50
	HCVU 0808	08	08	50
	HCVU 1010	10	10	25
	HCVU 1212	12	12	25

### Inch Fitting

HCVU	PART NO.	TUBE (Inch)	TUBE (Inch)	Qty/Box
	HCVU 5/32-5/32	5/32	5/32	50
	HCVU 1/4-1/4	1/4	1/4	50
	HCVU 5/16-5/16	5/16	5/16	50
	HCVU 3/8-3/8	3/8	3/8	25
	HCVU 1/2-1/2	1/2	1/2	25

# FLOW CONTROL VALVES

## Structural Diagram

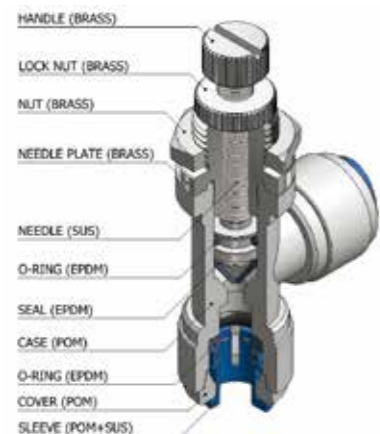

## Applications

- Constant flow rate by small airflow controlling

## Features

- Used for Water and Beverages
- Easy installation convenient to use
- Stable to use with frequent temperature changes

### • Working Pressure & Temperatures

°C	φ	5/32 ~ 1/2	4mm~12mm
25°C		10Bar	10Bar
65°C		7Bar	7Bar

### Metric Fitting

#### Flow Control Elbow Union

HSLB	PART NO.	TUBE (Metric)	TUBE (Metric)	Qty/Box
	HSLB 0606	06	06	50
	HSLB 1010	10	10	25

#### Flow Control Union Connector

HSTB	PART NO.	TUBE (Metric)	TUBE (Metric)	Qty/Box
	HSTB 0606	06	06	50
	HSTB 1010	10	10	25

#### Flow Control Elbow Union

HSLU	PART NO.	TUBE (Metric)	TUBE (Metric)	Qty/Box
	HSLU 0606	06	06	50
	HSLU 1010	10	10	25

#### Flow Control Union Connector

HSTU	PART NO.	TUBE (Metric)	TUBE (Metric)	Qty/Box
	HSTU 0606	06	06	50
	HSTU 1010	10	10	25

### Inch Fitting

#### Flow Control Elbow Union

HSLB	PART NO.	TUBE (Inch)	TUBE (Inch)	Qty/Box
	HSLB 1/4-1/4	1/4	1/4	50
	HSLB 3/8-3/8	3/8	3/8	25

#### Flow Control Union Connector

HSTB	PART NO.	TUBE (Inch)	TUBE (Inch)	Qty/Box
	HSTB 1/4-1/4	1/4	1/4	50
	HSTB 3/8-3/8	3/8	3/8	25

#### Flow Control Elbow Union

HSLU	PART NO.	TUBE (Inch)	TUBE (Inch)	Qty/Box
	HSLU 1/4-1/4	1/4	1/4	50
	HSLU 3/8-3/8	3/8	3/8	25

#### Flow Control Union Connector

HSTU	PART NO.	TUBE (Inch)	TUBE (Inch)	Qty/Box
	HSTU 1/4-1/4	1/4	1/4	50
	HSTU 3/8-3/8	3/8	3/8	25

## Flowrate

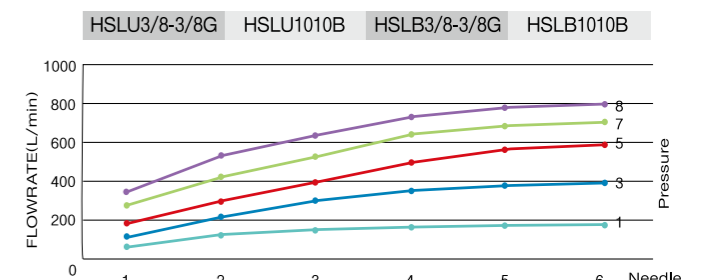
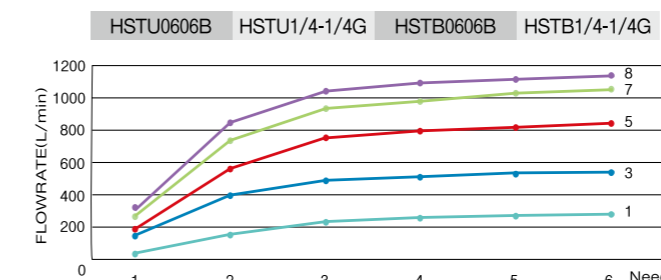
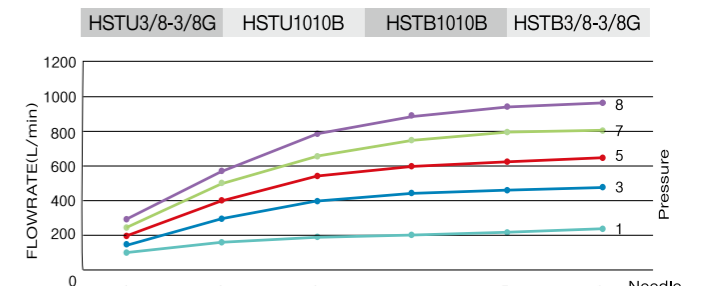
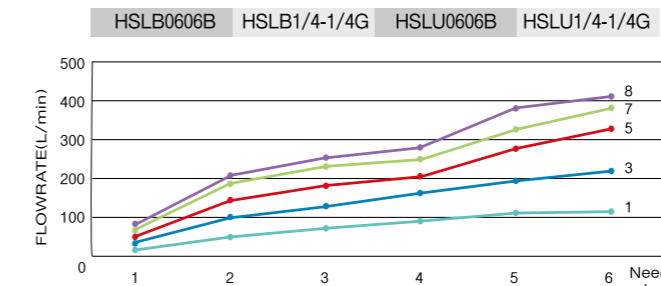

## Structural Diagram

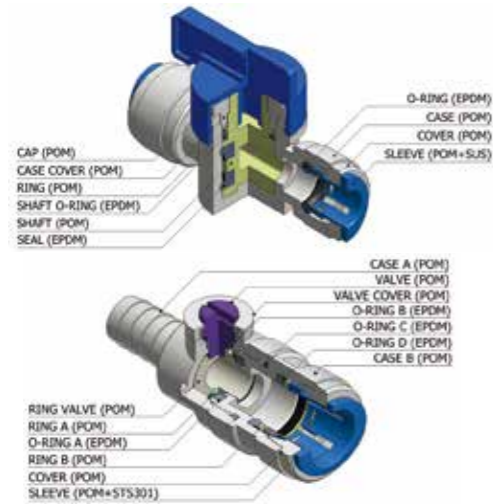

### Ball Valve (Shut-Off Valve)

HBVU	PART NO.	TUBE (Metric)	TUBE (Metric)	Qty/Box
	HBVU 0606	06	06	25
	HBVU 0808	08	08	25
	HBVU 1010	10	10	15
	HBVU 1212	12	12	15

### Ball Valve (Short Handle)

HBVU-S	PART NO.	TUBE (Metric)	TUBE (Metric)	Qty/Box
	HBVU 0606	06	06	25
	HBVU 0808	08	08	25
	HBVU 1010	10	10	15
	HBVU 1212	12	12	15

### Ball Valve (Shut-Off Valve)

HBVU	PART NO.	TUBE (Inch)	TUBE (Inch)	Qty/Box
	HBVU 1/4-1/4	1/4	1/4	25
	HBVU 5/16-5/16	5/16	5/16	25
	HBVU 3/8-3/8	3/8	3/8	15
	HBVU 1/2-1/2	1/2	1/2	15

### Ball Valve (Short Handle)

HBVU-S	PART NO.	TUBE (Inch)	TUBE (Inch)	Qty/Box
	HBVU 1/4-1/4	1/4	1/4	25
	HBVU 5/16-5/16	5/16	5/16	25
	HBVU 3/8-3/8	3/8	3/8	15
	HBVU 1/2-1/2	1/2	1/2	15

## Applications

- The user switches On-Off valve to supply compressed air or fluid
- Suitable for air and water

## Features

- Compact size and convenient to use in a narrow space
- Some valves are available without or with mouting clip
- Valves using for short or long handles depending on the application.

### Working Pressure & Temperatures

°C	Φ	5/32 ~ 1/2	4mm~12mm	15mm~22mm
25°C		10Bar	10Bar	7Bar
65°C		7Bar	7Bar	5Bar

### Barb Connector Valve

HCVB	PART NO.	TUBE (Metric)	Tube I.D (Inch)	Qty/Bag
	HCVB 15-1/2	15	1/2	20
	HCVB 22-1/2	22	1/2	20
	HCVB 22-3/4	22	3/4	20

Bulk packaging

### Angle Ball Valve

HASV	PART NO.	TUBE (Inch)	TUBE (Inch)	Qty/Bag
	HASV 3/8-3/8	3/8	3/8	20

Bulk packaging

### Female Adapter Ball Valve

HESV	PART NO.	TUBE (Inch)	THREAD (G)	Qty/Bag
	HESV 3/8-G04	3/8	G1/2	20

Bulk packaging

### Faucet Ball Valve Adapter

HAAV	PART NO.	TUBE (Inch)	THREAD (G)	Qty/Bag
	HAAV 1/4-G04	1/4	G1/2	20

Bulk packaging

## Structural Diagram

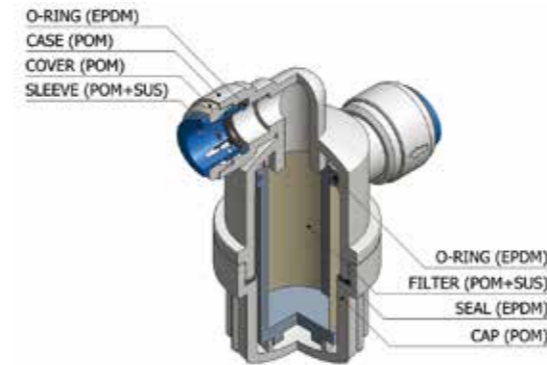

## Applications

- To prevent debris with stainless steel filter strainer applied 100 mesh or 200mesh

## Features

- The screw typed cap of the filer has an easy installation and maintenance

### Working Pressure & Temperatures

°C	Φ	5/32 ~ 1/2	4mm~12mm
25°C		10Bar	10Bar
65°C		7Bar	7Bar

### Metric Fitting

HBMU	PART NO.	TUBE (Metric)	TUBE (Metric)	Qty/Bag
	HBMU 0808	08	08	20
	HBMU 1010	10	10	20

Bulk packaging

### Inch Fitting

HBMU	PART NO.	TUBE (Inch)	TUBE (Inch)	Qty/Bag
	HBMU 1/4-1/4	1/4	1/4	20
	HBMU 3/8-3/8	3/8	3/8	20

Bulk packaging

## Structural Diagram

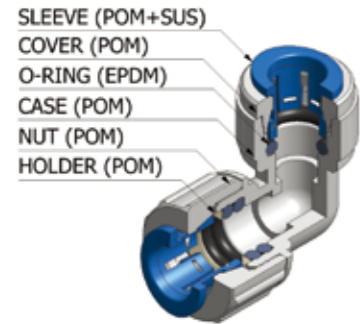

## Applications

- This product is used for stainless steel and other similar plated pipe & tube

## Features

- Two O-rings provide more sealing effect at high temperature  
- The nut & holder provides a stronger grip when connecting the pipe, and O-ring effectively seals the fitting

### Inch Fitting

#### Union Connector (Single)

### HUCP



PART NO.	TUBE (Inch)	TUBE (Inch)	Qty/Box
HUCP 1/4-5/16	1/4	5/16	50
HUCP 1/4-3/8	1/4	3/8	50
HUCP 5/16-5/16	5/16	5/16	50
HUCP 5/16-3/8	5/16	3/8	50
HUCP 5/16-1/2	5/16	1/2	50
HUCP 3/8-5/16	3/8	5/16	50
HUCP 3/8-3/8	3/8	3/8	50
HUCP 1/2-1/2	1/2	1/2	25

### Inch Fitting

#### Elbow Union (Double)

### HULS



PART NO.	TUBE (Inch)	TUBE (Inch)	Qty/Box
HULS 5/16-5/16	5/16	5/16	50

#### Elbow Union (Single)

### HULP



PART NO.	TUBE (Inch)	TUBE (Inch)	Qty/Box
HULP 1/4-5/16	1/4	5/16	50
HULP 1/4-3/8	1/4	3/8	50
HULP 5/16-5/16	5/16	5/16	50
HULP 5/16-3/8	5/16	3/8	50
HULP 3/8-5/16	3/8	5/16	50
HULP 3/8-3/8	3/8	3/8	50
HULP 1/2-1/2	1/2	1/2	25

## Applications

- Cartridges are available in acetal and brass.  
- Offers more cost-effectiveness compared to fittings.  
- Designed effectively for easy assembly and time saving.  
- The cartridge consists of EPDM O-ring and acetal collet (Sleeve).

### 1. Half Cartridges

#### Metric Fitting

##### Acetal Cartridge

### HCAS-P



PART NO.	TUBE (Metric)	Qty/Bag
HCAS-P04	04	1,000
HCAS-P06	06	1,000
HCAS-P08	08	1,000
HCAS-P10	10	1,000
HCAS-P12	12	1,000

Bulk packaging

### 2. Full Cartridges

#### Metric Fitting

##### Brass Cartridge

### HCAS-F



PART NO.	TUBE (Metric)	Qty/Bag
HCAS-F 04	04	1,000
HCAS-F 06	06	1,000
HCAS-F 08	08	1,000
HCAS-F 10	10	1,000
HCAS-F 12	12	1,000

Bulk packaging

### Inch Fitting

##### Acetal Cartridge

### HCAS-P



PART NO.	TUBE (Inch)	Qty/Bag
HCAS-P 5/32	5/32	1,000
HCAS-P 1/4	1/4	1,000
HCAS-P 5/16	5/16	1,000
HCAS-P 3/8	3/8	1,000
HCAS-P 1/2	1/2	1,000

Bulk packaging

### Metric Fitting

##### Brass Cartridge

### HCAS-H



PART NO.	TUBE (Metric)	Qty/Bag
HCAS-H 04	04	1,000
HCAS-H 06	06	1,000
HCAS-H 08	08	1,000
HCAS-H 10	10	1,000
HCAS-H 12	12	1,000

Bulk packaging

### Inch Fitting

##### Brass Cartridge

### HCAS-H



PART NO.	TUBE (Inch)	Qty/Bag
HCAS-H 5/32	5/32	1,000
HCAS-H 1/4	1/4	1,000
HCAS-H 5/16	5/16	1,000
HCAS-H 3/8	3/8	1,000
HCAS-H 1/2	1/2	1,000

Bulk packaging

## How to assemble the cartridge



## Metric Fitting

### Locking Clip



HCP	PART NO.	TUBE(Metric)	Qty/Box
	HCP 04	04	1000
	HCP 06	06	1000
	HCP 08	08	1000
	HCP 10	10	1000
	HCP 12	12	1000
	HCP 15	15	500
	HCP 22	22	300

## Inch Fitting

### Locking Clip

HCP	PART NO.	TUBE(Inch)	Qty/Box
	HCP 5/32	5/32	1000
	HCP 3/16	3/16	1000
	HCP 1/4	1/4	1000
	HCP 5/16	5/16	1000
	HCP 3/8	3/8	1000
	HCP 1/2	1/2	1000

### Mounting Clip

HMCP	PART NO.	TUBE O.D	Qty/Box
	HMCP 06-1/4	6mm or 1/4	Bulk
	HMCP 10-3/8	10mm or 3/8	Bulk
	Use example 		

### Spanner

HRT	PART NO.	TUBE O.D
	HRT	5/32 or 3/16 or 4mm
	HRT	1/4 or 6mm
	HRT	5/16 or 8mm
	HRT	3/8 or 10mm
	HRT	1/2 or 12mm

### Tube Cutter

ETC	PART NO.
	ETC-20

Our tube is produced in Linear Low Density Polyethylene (LLDPE) and tube can be used for wide range of temperature and pressure suitability. Fluidfit tube is NSF & ACS certified with requirement water & food applications

## Applications

- water purification, water conditioners, ice makers, misting systems and food contact application

## Features

- A wide range of temperature and pressure suitability
- Broad chemical compatibility
- PE tubing is made from FDA compliant and non contaminating materials

## Specifications

- Tube Tolerance : +0.1mm/-0.1mm
- Temperature : -20°F(-29°C) ~ +150°F(66°C)

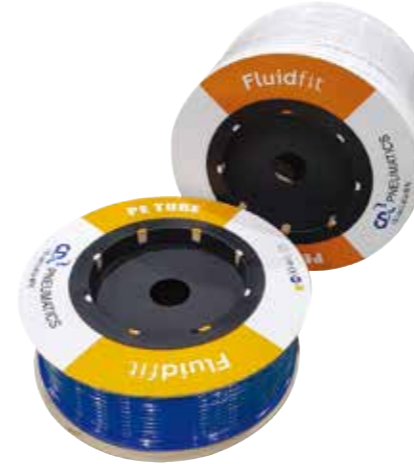

## Maximum Pressure

Size	5/32"	3/16"	1/4"	5/16"	3/8"	1/2"
	4mm	5mm	6mm	8mm	10mm	12mm
Pressure	230 PSI			170 PSI		

## Available Color and Sizes



### Metric size tube

PART NO.	Material	O.D (mm)	I.D (mm)	Reel Length(Meter)
PE 0425	LLDPE	4	2.5	200
PE 0640	LLDPE	6	4	100
PE 0860	LLDPE	8	6	100
PE 1070	LLDPE	10	7	100
PE 1290	LLDPE	12	9	100

### Inch size tube

PART NO.	Material	O.D (mm)	I.D (mm)	Reel Length(Meter)
PE 5/32	LLDPE	4	2.5	200
PE 3/16	LLDPE	4.76	3.17	200
PE 1/4	LLDPE	6.35	4.32	100
PE 5/16	LLDPE	8	5.48	100
PE 3/8	LLDPE	9.52	6.35	100
PE 1/2	LLDPE	12.7	9.52	100







## WARNING AND CAUTION

- USE EACH PRODUCT ONLY FOR RECOMMENDED APPLICATIONS.
- FLUIDFIT PRODUCTS ARE ORIGINALLY DESIGNED FOR USE WITH WATER, FOOD, OR BEVERAGE PRODUCTS. FOR OTHER CHEMICALS REFER TO CHEMICAL COMPATIBILITY DATA (CHART) PROVIDED. FOR UNLISTED CHEMICALS OR MEDIA PLEASE CONTACT US.
- DO NOT DISASSEMBLE OR MODIFY THE PRODUCTS. IT MAY CAUSE MALFUNCTION, LEAK, OR FAILURE AND VOIDS THE PRODUCT WARRANTY.
- DO NOT APPLY EXCESSIVE STRESS ON FITTING BY ROTATION, TWIST, BENDING, SHOCK. THIS MAY DAMAGE THE FITTING OR CAUSE MALFUNCTION, LEAK, OR FAILURE AND VOIDS THE PRODUCT WARRANTY.
- DO NOT USE THE PRODUCTS AT THE TEMPERATURE EXCEEDING 80°C. THIS MAY CAUSE MALFUNCTION, LEAK, OR FAILURE.
- DO NOT USE PIPE GLUE OR OTHER LIQUID SEALANTS OTHER THAN TEFLON TAPE WHEN SEALING THREADED FITTINGS.
- DO NOT PRESS COLLET TOWARD BODY OR ATTEMPT TO PULL OUT TUBING WHEN THE LINE IS PRESSURED.
- USE LOCKING CLIPS TO PREVENT UNINTENDED SEPARATION.
- WHEN TIGHTENING THREADED FITTINGS, REFER TO TORQUE DATA PROVIDED. OVER TORQUE MAY DAMAGE THE FITTING AND CAUSE LEAK OR FAILURE.
- BEFORE DISASSEMBLING TUBE CONNECTION, VERIFY IF THE LINE PRESSURE HAS BEEN REMOVED.
- FLUIDFIT PRODUCTS MAY BE MODIFIED OR REDESIGNED AS TO MARKET REQUIREMENT FOR IMPROVEMENT WITHOUT NOTICE, THEREFORE THE ACTUAL PRODUCT MAY DIFFER FROM PICTURES PROVIDED.



### Head Office

#30 1Gil Secheon-ro, Dasa-eup,  
Dalseong-gun, Daegu, Korea  
TEL : 82-53-354-7501 FAX : 82-53-353-7573

### Seoul Office

#579 Gyengin-ro Guro-gu, Seoul Korea  
(A-#207 Ansung Building)  
Tel: + 82 2 2678 0069 Fax : +82 2 2675 8265

# Fluidfit