

AIR CYLINDER

Series A20, A21

Cat No A20, A21 - 01 - 02 - C

Double End Double Acting Cylinders (Square type) Ø32 - 125 mm

Features

- ❑ Adjustable cushioning at both ends with elastomer pads
- ❑ Wide varieties of mountings as per ISO 15552 / VDMA 24562 standards
- ❑ Magnetic and Non magnetic version
- ❑ Aluminium profile (square) cylinder barrel
- ❑ Magnetic sensor common for all sizes (Refer Magnetic sensor catalogue)
- ❑ High temperature (Viton seals) 150°C max.
- ❑ Non corrosive Stainless steel piston rod and piston rod lock nut (SS 304)



Technical Specifications

Cylinder bore Ø	(mm)	32	40	50	63	80	100	125	
Cushion stroke	(mm)	21	23	23	23	28	28	40	
Standard strokes *	(mm)	25, 50, 80, 100, 125, 160, 200, 250, 300, 320, 400, 500						50, 80, 100, 125, 160, 200, 250, 300, 320, 400, 500	
Medium		Compressed air - filtered - lubricated							
Working pressure		0.5 - 10 bar							
Medium temperature	Regular	5° - 60° C							
	High temperature applications**	5° - 150° C max.							
Materials of construction		Aluminium, Brass, Nitrile, Steel, Acetal, Polyurethane							
Mountings		Basic cylinder, Foot mounting, Flange, Female clevis, Trunnion,							
Accessories		Trunnion bracket, Rod end fork, Rod end aligner, Rod end spherical eye							

* For Non standard or longer stroke cylinders, contact your regional dealer or **JANATICS**

** Refer Special Ordering number.

Output force (force in N : 1N = 0.1 kgf)

Cylinder bore Ø (in mm)	Rod Ø (in mm)	Working pressure in bar								
		2	3	4	5	6	7	8	9	10
32	12	124	187	249	311	373	435	498	559	621
40	16	190	285	380	475	570	665	760	855	950
50	20	297	445	594	742	891	1039	1187	1336	1484
63	20	505	757	1009	1261	1514	1766	2018	2270	2523
80	25	816	1225	1633	2041	2449	2857	3266	3674	4082
100	25	1325	1988	2650	3313	3976	4640	5300	5965	6625
125	32	2064	3096	4128	5160	6192	7224	8256	9288	10320

(Above values have been worked out taking frictional loss into consideration)

AIR CYLINDER

Series A20, A21

Cat No A20, A21 - 01 - 02 - C

Basic cylinder

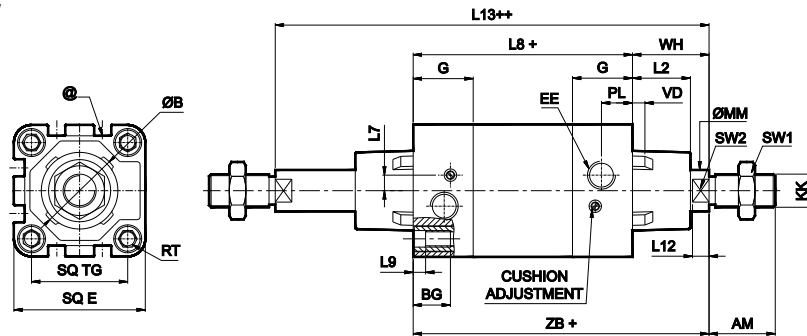

+ Add stroke
++ Add stroke twice

Cylinder bore Ø	KK	AM	MM	SW2	L12	SW1	B e11	VD	L2	E max	G	TG	RT	BG min	EE	PL	L7	WH	Tol	ZB	Tol	L8	Tol	L9	L13	Tol	Stroke tol
32	M10x1.25	22	12	10	6	17	30	6	18.5	45	25.5	32.5	M6	16	G1/8	13	5	26	±1.3	120	±1	94	±0.6	5	147		+ 2 + 0
40	M12x1.25	24	16	13	6.5	19	35	6.5	20.5	51	29	38	M6	16	G1/4	14.5	5	30		135		105		5	166		
50	M16x1.5	32	20	16	8	24	40	6.5	28	64	29	46.5	M8	16	G1/4	15	7.5	37		143		106	±0.7	6	181	±1.5	+ 2.5 + 0
63	M16x1.5	32	20	16	8	24	45	6.5	27.5	74	35	56.5	M8	16	G3/8	17	10	37		158	±1.1	121		6	196		
80	M20x1.5	40	25	21	10	30	45	6.5	34	94	35	72	M10	16	G3/8	18	14	46		174		128	±0.8	6	221		
100	M20x1.5	40	25	21	10	30	55	6.5	35	111	38.5	89	M10	16	G1/2	18	10	51		189		138		6	241		
125	M27x2	54	32	27	13	41	60	10	48.5	136	44	110	M12	24	G1/2	20	12	65	±2.2	225	±1.2	160	±1	9.5	292	±2	+ 4 + 0

@ - T Groove for magnetic sensor, Refer catalogue series AM4

Foot mounting

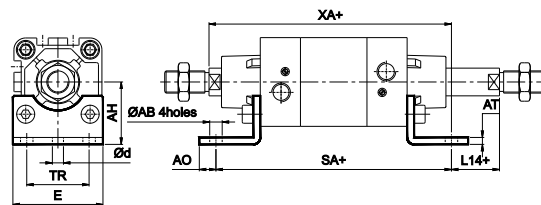

Cylinder bore Ø	TR ±0.3	AB H14	AH JS15	AO max	AT	E	d*	SA	Tol	L14	Tol	XA	Tol	Recommended Bolt size	Ordering no.
32	32	7	32	8	4	46	5.8	142		3	±1.5	144		M6	ML1032
40	36	10	36	10	4	52	7.8	161	±1.25	3		163	±1.25	M8	ML1040
50	45	10	45	12	5	65	7.8	170		6		175		M8	ML1050
63	50	10	50	12	5	75	7.8	185		6	±1.8	190		M8	ML1063
80	63	12	63	17	6	95	9.8	210	±1.6	6		215	±1.5	M10	ML1080
100	75	14.5	71	19	6	115	11.8	220		11		230		M12	ML1100
125	90	16.5	90	17	8	140	11.8	250	±2	22	±2.5	270	±2	M12	ML1125

* Suitable for reaming

Flange

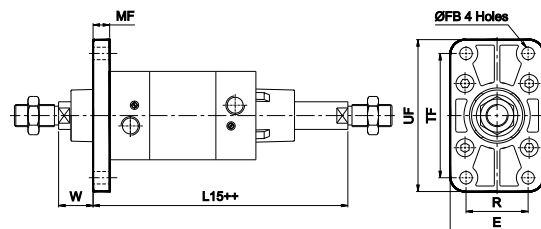

Cylinder bore Ø	TF ± 0.3	R ± 0.3	FB H13	MF	UF	E	W	Tol	L15	Tol	Recommended Bolt size	Ordering no.
32	64	32	7	10	80	50	16		131		M6	MF1032
40	72	36	9	10	90	55	20	±1.5	146	±1.25	M8	MF1040
50	90	45	9	12	110	68	25		156		M8	MF1050
63	100	50	9	12	125	78	25		171		M8	MF1063
80	126	63	12	16	155	100	30	±1.8	191	±1.5	M10	MF1080
100	150	75	14	16	185	120	35		206		M12	MF1100
125	180	90	16	20	211	141	45	±2.5	247	±2	M12	MF1125

Female clevis

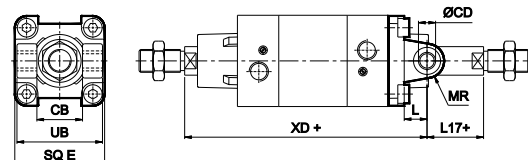

Cylinder bore Ø	CD H9	CB H14	L	MR max	UB h14	E max	L17	Tol	XD	Tol	Ordering no.
32	10	26	12	11	45	45	5		142		MB1032
40	12	28	15	13	52	51	6	±1.5	160	±1.25	MB1040
50	12	32	15	13	60	64	11		170		MB1050
63	16	40	20	17	70	74	6	±1.8	190		MB1063
80	16	50	20	17	90	94	11		210	±1.5	MB1080
100	20	60	25	21	110	111	11		230		MB1100
125	25	70	30	26	130	140	17	±2.5	275	±2	MB1125

AIR CYLINDER

Series A20, A21

Cat No A20, A21 - 01 - 02 - C

Trunnion

++ Add stroke twice

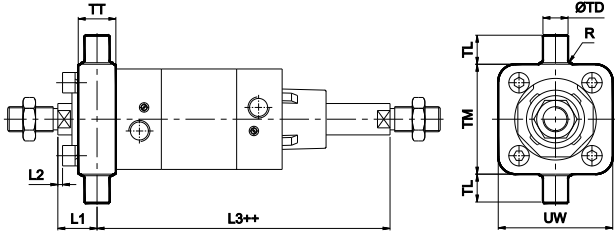

Cylinder bore Ø	TD e9	TL h14	TM h14	UW	TT	R	L1	Tol	L2 approx	L3	Tol	Ordering no.
32	12	12	50	48	16	1	18		2	129		MT1032
40	16	16	63	55	22	1.5	19	±1.5	0	147	±1.5	MT1040
50	16	16	75	70	24	1.6	25		3	156		MT1050
63	20	20	90	86	28	1.6	23		-1	173		MT1063
80	20	20	110	110	32	1.6	30	±1.8	1.8	191	±2	MT0080
100	25	25	132	135	40	2	31		-1.2	210		MT0100
125	25	25	160	155	44	2	43	±2	6.5	249	±2.5	MT1125

Accessories for Air Cylinder series A20, A21

Trunnion bracket

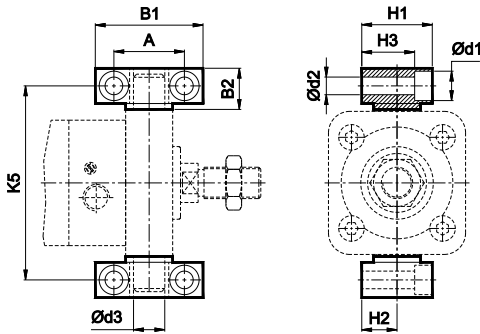

Cylinder bore Ø	B1	B2	A	d1	d2 H13	d3 H9	H1	H2	H3	K5 Js14	Ordering no.
32	46	18	32 ±0.2	11	6.6	12	30	15 ±0.1	23	71	AT032
40	55	21	36 ±0.2	15	9	16	36	18 ±0.1	27	87	AT040
50	55	21	36 ±0.2	15	9	16	36	18 ±0.1	27	99	AT040
63	65	23	42 ±0.2	16.5	11	20	40	20 ±0.1	29	116	AT063
80	65	23	42 ±0.2	16.5	11	20	40	20 ±0.1	29	136	AT063
100	75	28.5	50 ±0.2	20	14	25	50	25 ±0.1	37	164	AT100
125	75	28.5	50 ±0.2	20	14	25	50	25 ±0.1	37	192	AT100

Rod end Fork (ISO 8140)

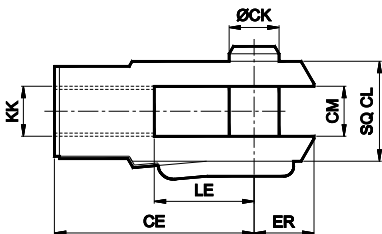

Cylinder bore Ø	KK	CE	CK f 8	CM B12	LE	ER max	CL	Ordering no.
32	M10 x 1.25	40	10	10	20	16	20	AF010
40	M12 x 1.25	48	12	12	24	19	24	AF012
50 / 63	M16 x 1.5	64	16	16	32	25	32	AF016
80 / 100	M20 x 1.5	80	20	20	40	32	40	AF020
125	M27 x 2	110	30	30	55	45	55	AF030

Rod end Aligner

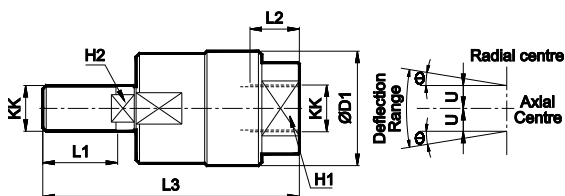

Cylinder bore Ø	KK	L1	L2	L3	H1	H2	D1	U	± 0°	Ordering no.
32	M10 x 1.25	20	14	65	17	8	28	0.75	5	AR010
40	M12 x 1.25	22	18	75	19	10	32	1	5	AR012
50 / 63	M16 x 1.5	25	22	91	27	13	41	1	5	AR016
80 / 100	M20 x 1.5	30	28	112	32	16	50	1.5	5	AR020

Rod end spherical eye (ISO 8139)

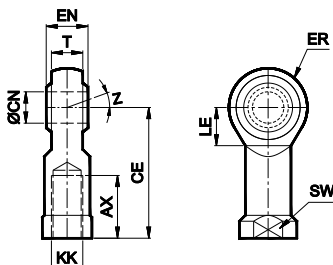

Cylinder bore Ø	KK	CN H9	T	EN h12	CE	LE min	ER max	AX	SW	Z	Ordering no.
32	M10 x 1.25	10	10.5	14	43	15	14	20	17	13°	AP010
40	M12 x 1.25	12	12	16	50	17	16	22	19		AP012
50 / 63	M16 x 1.5	16	15	21	64	22	21	28	22	15°	AP016
80 / 100	M20 x 1.5	20	18	25	77	26	25	33	30/32		AP020
125	M27 x 2	30	25	37	110	36	35	51	41		AP027

AIR CYLINDER

Series A20, A21

Cat No A20, A21 - 01 - 02 - C

How to order

A

Model		Piston Ø (mm)		Stroke (mm)		Mountings		Special Cylinders	
20	Magnetic cylinder	032	- Ø 32	025	- 25	O	- Basic	H	- High temp
21	Standard cylinder	040	- Ø 40	050	- 50	L	- Foot Mounting	S	- SS piston rod
		050	- Ø 50	080	- 80	F	- Flange		
		063	- Ø 63	100	- 100	B	- Female Clevis		
		080	- Ø 80	125	- 125	N	- Trunnion		
		100	- Ø 100	160	- 160				
		125	- Ø 125	200	- 200				
				250	- 250				
				300	- 300				
				320	- 320				
				400	- 400				
				500	- 500				

Note

For details of Accessories for Magnetic sensor, refer catalogue **Series AM4** (Page no. 1a.1.1)

Example :

Ordering no. for standard cylinder with 40 dia bore, 50 mm stroke with female clevis mounting with High temp: **A21 040 050 B - T**



Note:

If ordered as 40 dia, 50 mm stroke cylinder, Basic cylinder **A21 040 050 O** will be supplied.

For repeat order when the details are taken from cylinder nameplate, mention the mounting style separately.

For ordering **Accessories** refer corresponding tables for part numbers.

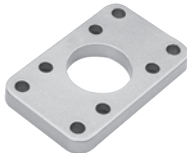
For ordering individual **Mounting** kits (If needed separately) the order numbers are as below

Cylinder bore Ø	Foot mounting *	Flange *	Female clevis *	Trunnion *
				
32	ML1032	MF1032	MB1032	MT1032
40	ML1040	MF1040	MB1040	MT1040
50	ML1050	MF1050	MB1050	MT1050
63	ML1063	MF1063	MB1063	MT1063
80	ML1080	MF1080	MB1080	MT0080
100	ML1100	MF1100	MB1100	MT0100
125	ML1125	MF1125	MB1125	MT1125

* Supplied with 4nos. of screws

For your special requirements of cylinders or for further informations contact your regional dealer or **JANATICS**

Subject to change