

## AIR CYLINDER

### Series A12, A13

Cat No A12, A13 - 01 - 03

### AIR CYLINDERS Double Acting ( Ø32 - 100 ) mm

As per ISO 6431 / CETOP RP43P, RP53P standards

#### Features

- Adjustable cushioning at both ends
- Wide varieties of mountings
- Low friction
- Long life

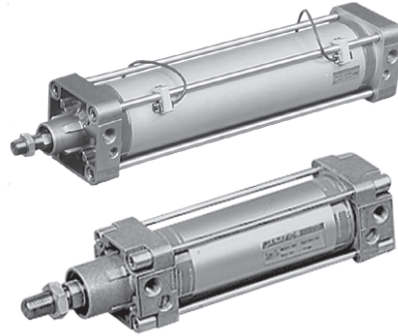

#### Technical Specifications

Cylinder bore Ø ( mm )	32	40	50	63	80	100
Cushion stroke ( mm )	21	23	23	23	28	28
Standard strokes* ( mm )	25 50 80 100 125 160 200 250 300 320 400 500					
Medium	Compressed air – filtered – lubricated					
Working pressure	0.5 - 10 bar					
Medium temperature	5° - 60° C					
Materials of construction	Aluminium, Brass, Nitrile, Steel, Acetal, Iron, Bronze, polyurethane					
Mountings	Basic cylinder, Foot mounting, Front flange, Rear flange, Male clevis, Female clevis, Front trunnion, Rear trunnion, Centre trunnion					
Accessories	Clevis foot bracket, Wall mounting bracket, Trunnion bracket, Rod end fork, Rod end aligner, Rod end spherical eye					

\* For Non standard or longer stroke cylinders, contact your regional dealer or JANATICS

#### Output force ( force in N : 1N = 0.1 kgf )

Cylinder bore Ø (in mm)	Rod Ø (in mm)		Working pressure in bar								
			2	3	4	5	6	7	8	9	10
32	12	Extend	145	217	289	362	434	507	579	651	724
		Retract	124	187	249	311	373	435	498	559	621
40	16	Extend	226	339	452	565	678	792	905	1018	1130
		Retract	190	285	380	475	570	665	760	855	950
50	20	Extend	353	530	706	884	1060	1237	1414	1590	1767
		Retract	297	445	594	742	891	1039	1187	1336	1484
63	20	Extend	561	842	1122	1403	1683	1964	2244	2525	2805
		Retract	505	757	1009	1261	1514	1766	2018	2270	2523
80	25	Extend	905	1357	1809	2262	2714	3167	3619	4072	4524
		Retract	816	1225	1633	2041	2449	2857	3266	3674	4082
100	25	Extend	1414	2120	2828	3534	4241	4948	5655	6362	7069
		Retract	1325	1988	2650	3313	3976	4640	5300	5965	6625

( Above values have been worked out taking frictional loss into consideration )

# AIR CYLINDER

Series A12, A13

Cat No A12, A13 - 01 - 03

## Basic cylinder

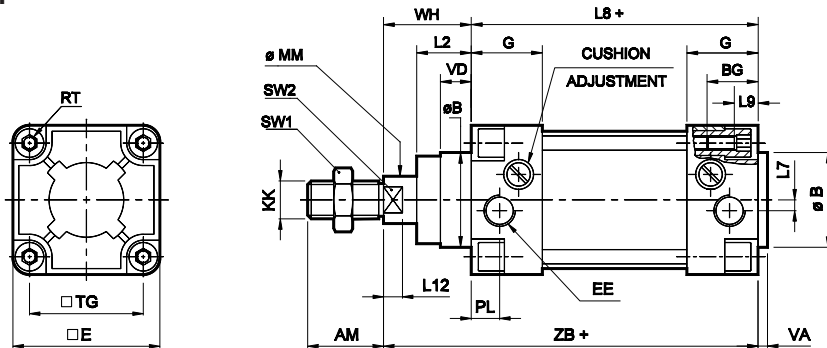

+ Add stroke

Cylinder bore Ø	KK	AM	MM	SW2	L12	SW1	B e11	VD	VA	L2	E max	G	TG	RT	BG min	L9	EE	PL	L7	WH	ZB	L8	Stroke tol
32	M10 x 1.25	22	12	10	6	17	30	11	3.5	20.5	44	25	32	M6	16	5	G1/8	8.5	0	26 ± 1.3	120 ± 0.9	94	+2 0
40	M12 x 1.25	24	16	13	6.5	19	35	12	4	24.5	55	28	40	M6	16	5	G1/4	12	3	30 ± 1.3	135 ± 0.9	105	
50	M16 x 1.5	32	20	16	8	24	40	13	4	30	63	30	48	M6	16	5	G1/4	12	5	37 ± 1.3	143 ± 0.9	106	
63	M16 x 1.5	32	20	16	8	24	45	14.5	4	30.5	83	33	60	M8	16	6	G3/8	16.5	10	37 ± 1.7	158 ± 1.1	121	+2.5 0
80	M20 x 1.5	40	25	21	10	30	45	5	4	38.5	98	33	72	M10	16	6	G3/8	16	15	46 ± 1.7	174 ± 1.1	128	
100	M20 x 1.5	40	25	21	10	30	55	20	4	44	115	37	89	M10	16	6	G1/2	18	15	51 ± 1.7	189 ± 1.1	138	

## Foot mounting

+ Add stroke

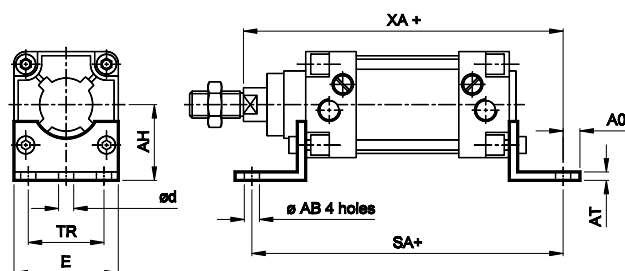

Cylinder bore Ø	TR ±0.3	AB	AH Js15	AO max.	AT	E	SA	Tol	d*	XA	Tol	Ordering no.
32	32	7 H14	32	8	4	46	142	±1.25	5.8	144	±1.25	ML1032
40	36	9 H13	36	10	4	52	161		7.8	163		ML040
50	45	9 H13	45	12	5	65	170		7.8	175		ML050
63	50	9 H13	50	12	5	75	185	±1.5	7.8	190	±1.5	ML063
80	63	12 H14	63	17	6	95	210		9.8	215		ML1080
100	75	14.5 H14	71	19	6	115	220		11.8	230		ML1100

\* Suitable for reaming

## Front flange

+ Add stroke

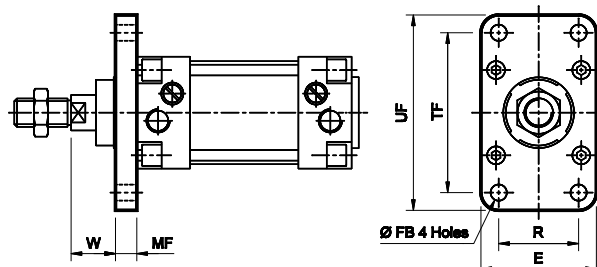

Cylinder bore Ø	TF ± 0.3	R ± 0.3	FB H13	MF	UF max.	E max.	W	Tol	Ordering no.
32	64	32	7	10	80	50	16	±1.5	MF1032
40	72	36	9	10	90	55	20		MF040
50	90	45	9	12	110	65	25		MF050
63	100	50	9	12	125	83	25	±1.8	MF063
80	126	63	12	16	155	100	30		MF1080
100	150	75	14	16	185	120	35		MF1100

## Rear flange

+ Add stroke

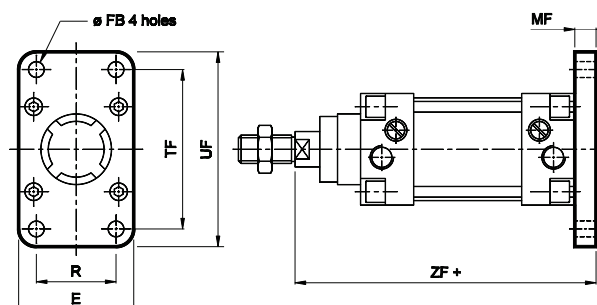

Cylinder bore Ø	TF ± 0.3	R ± 0.3	FB H13	MF	UF	E	ZF	Tol	Ordering no.
32	64	32	7	10	80	50	130	±1.25	MF1032
40	72	36	9	10	90	55	145		MF040
50	90	45	9	12	110	65	155		MF050
63	100	50	9	12	125	83	170	±1.5	MF063
80	126	63	12	16	155	100	190		MF1080
100	150	75	14	16	185	120	205		MF1100

# AIR CYLINDER

Series A12, A13

Cat No A12, A13 - 01 - 03

## Male clevis

+ Add stroke

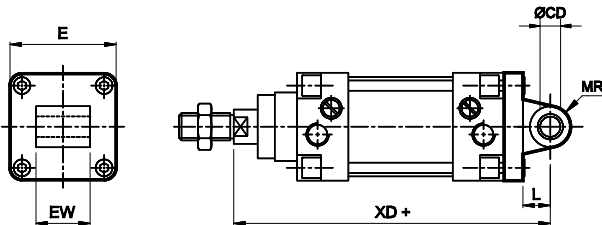

Cylinder bore Ø	CD H9	EW	Tol	L min	MR max	E max	XD	Tol	Ordering no.
32	10	26	- 0.2 - 0.6	12	11	45	142	± 1.25	MS032
40	12	28		15	13	54	160		MS040
50	12	32		15	13	64	170		MS050
63	16	40	± 1.5	20	17	82	190	± 1.5	MS063
80	16	50		20	17	94	210		MS1080
100	20	60		25	21	111	230		MS1100

## Female clevis

+ Add stroke

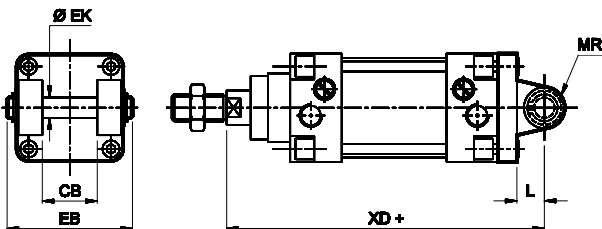

Cylinder bore Ø	EK e8	L min	MR max	EB max	CB H14	XD	Tol	Ordering no.
32	10	12	11	56	26	142	± 1.25	MD032
40	12	15	13	65	28	160		MD040
50	12	15	13	73	32	170		MD050
63	16	20	17	86	40	190	± 1.5	MD063
80	16	20	17	106	50	210		MD1080
100	20	25	21	129	60	230		MD1100

## Front trunnion

+ Add stroke

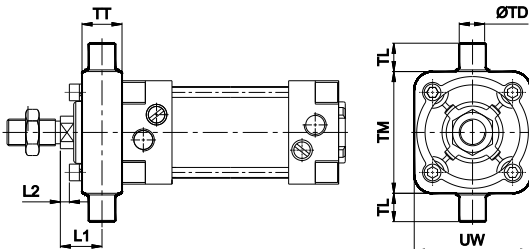

Cylinder bore Ø	TD e9	TL h14	TM h14	UW	TT	R	L1	Tol	L2 approx	Ordering no.
32	12	12	50	48	16	1	18	± 1.5	2	MT0032
40	16	16	63	55	22	1.5	19		0	MT0040
50	16	16	75	70	24	1.6	25		5	MT0050
63	20	20	90	86	28	1.6	23	± 2	-1	MT0063
80	20	20	110	110	32	1.6	30		1.5	MT0080
100	25	25	132	135	40	2	31		-1.5	MT0100

## Rear trunnion

+ Add stroke

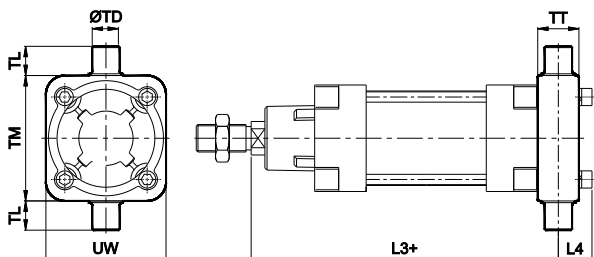

Cylinder bore Ø	TD e9	TL h14	TM h14	UW	TT	R	L3	Tol	L4 approx	Ordering no.
32	12	12	50	48	16	1	128	± 1.2	16	MT0032
40	16	16	63	55	22	1.5	146		19	MT0040
50	16	16	75	70	24	1.6	155		20	MT0050
63	20	20	90	86	28	1.6	172	± 1.3	24	MT0063
80	20	20	110	110	32	1.6	190		29	MT0080
100	25	25	132	135	40	2	209		33	MT0100

## Centre trunnion

+ Add stroke

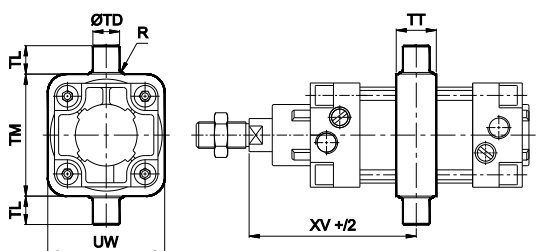

Cylinder bore Ø	TD e9	TL h14	TM h14	UW	TT	R	XV	Tol
32	12	12	50	48	16	1	73	± 2
40	16	16	63	55	22	1.5	82.5	
50	16	16	75	70	24	1.6	90	
63	20	20	90	86	28	1.6	97.5	
80	20	20	110	110	32	1.6	110	
100	25	25	132	135	40	2	120	

Note : Cylinder with centre trunnion is factory fitted, please contact JANATICS - H.O

# AIR CYLINDER

Series A12, A13

Cat No A12, A13 - 01 - 03

## Accessories for Air Cylinder series A12, A13

### Clevis foot bracket ( CETOP - RP 107 P )

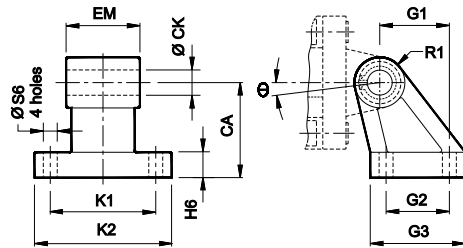

Cylinder bore Ø	K1 Js14	G2 Js14	S6 H13	CA Js16	CK H9	EM	Toi	G1 ±0.2	H6	R1 max	K2	G3	θ°	Ordering no. @
32	38	18	5.5	32	10	26	- 0.2 - 0.6	21	9	10	51	31	10	AA032
40	41	22	5.5	36	12	28		24	10	11	54	35	15	AA040
50	50	30	6.6	45	12	32		33	12	13	65	45	15	AA050
63	52	35	6.6	50	16	40		37	12	15	67	50	15	AA063
80	66	40	9	63	16	50		47	14	15	86	60	15	AA080
100	76	50	9	71	20	60		55	15	19	96	70	15	AA100

@ Adoptable to cylinder with female clevis

### Wall mounting bracket

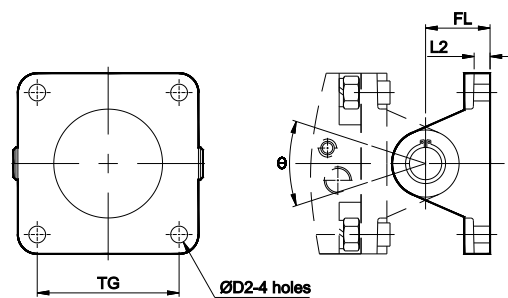

Cylinder bore Ø	TG	D2	L2	FL	θ°	Ordering no. @	Ordering no. #
32	32	6.6	5.5	22	90	AV032	AW032
40	40	6.6	5.5	25	90	AV040	AW040
50	48	6.6	6.5	27	90	AV050	AW050
63	60	9	6.5	32	90	AV063	AW063
80	72	11	10	36	60	AV1080	AW1080
100	89	11	10	41	60	AV1100	AW1100

@ Adoptable to cylinder with male clevis  
# Adoptable to cylinder with female clevis

### Trunnion bracket

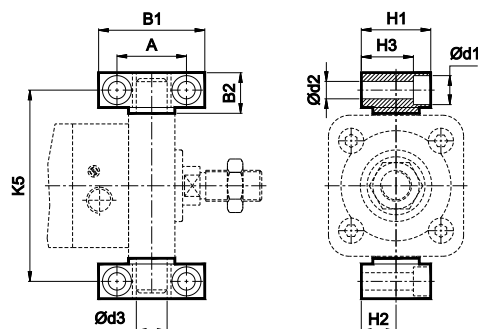

Cylinder bore Ø	B1	B2	A	d1	d2 H13	d3 H9	H1	H2	H3	K5 Js14	Ordering no.
32	46	18	32 ±0.2	11	6.6	12	30	15 ±0.1	23	71	AT032
40	55	21	36 ±0.2	15	9	16	36	18 ±0.1	27	87	AT040
50	55	21	36 ±0.2	15	9	16	36	18 ±0.1	27	99	AT040
63	65	23	42 ±0.2	16.5	11	20	40	20 ±0.1	29	116	AT063
80	65	23	42 ±0.2	16.5	11	20	40	20 ±0.1	29	136	AT063
100	75	28.5	50 ±0.2	20	14	25	50	25 ±0.1	37	164	AT100

### Rod end Fork ( ISO 8140 )

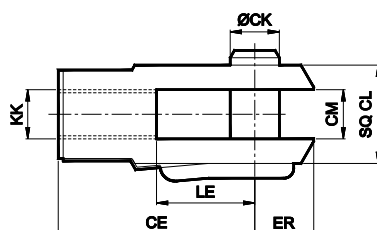

Cylinder bore Ø	KK	CE	CK f 8	CM B12	LE	ER max	CL	Ordering no.
32	M10 x 1.25	40	10	10	20	16	20	AF010
40	M12 x 1.25	48	12	12	24	19	24	AF012
50 / 63	M16 x 1.5	64	16	16	32	25	32	AF016
80 / 100	M20 x 1.5	80	20	20	40	32	40	AF020

# AIR CYLINDER

Series A12, A13

Cat No A12, A13 - 01 - 03

## Rod end Aligner

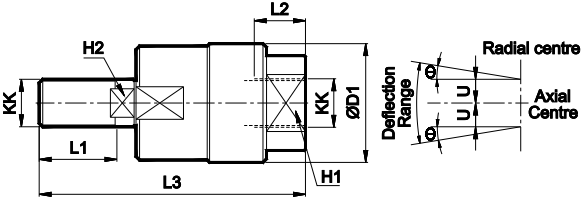

Cylinder bore Ø	KK	L1	L2	L3	H1	H2	D1	U	± θ°	Ordering no.
32	M10 x 1.25	20	14	65	17	8	28	0.75	5	AR010
40	M12 x 1.25	22	18	75	19	10	32	1	5	AR012
50 / 63	M16 x 1.5	25	22	91	27	13	41	1	5	AR016
80 / 100	M20 x 1.5	30	28	112	32	16	50	1.5	5	AR020

## Rod end spherical eye ( ISO 8139 )

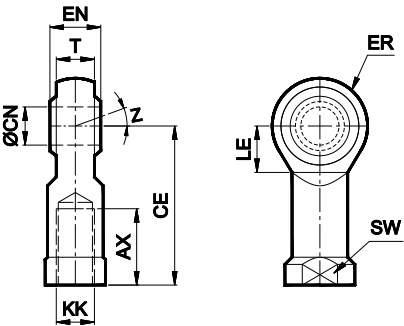

Cylinder bore Ø	KK	CN H9	T	EN h12	CE	LE min	ER max	AX	SW	Z	Ordering no.
32	M10 x 1.25	10	10.5	14	43	15	14	20	17	13°	AP010
40	M12 x 1.25	12	12	16	50	17	16	22	19		AP012
50 / 63	M16 x 1.5	16	15	21	64	22	21	28	22	15°	AP016
80 / 100	M20 x 1.5	20	18	25	77	26	25	33	30/32		AP020

# AIR CYLINDER

Series A10, A13

Cat No A12, A13 - 01 - 03

## ACCESSORIES FOR MAGNETIC CYLINDERS Series A10, A13

### REED SWITCH

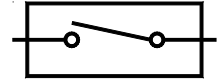

#### Function

The reed switch and clamping kit assembly is mounted on the Air cylinder (Series A10, A13), for proximity sensing. The piston of the cylinder is equipped with a permanent magnet which activates the reed switch on approaching it. The reed switch closes the circuit giving an electrical signal, which could be used further as required. The accuracy of the sensing distance depends on the speed of operation of the piston.

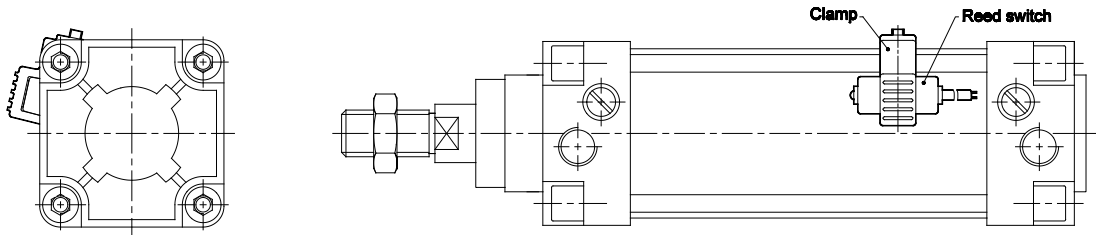

#### Technical Specifications - Reed Switch

Model	880006
Operating voltage	DC / AC 5 - 240V
Switching current	100mA max
Switch rating	10 W max
Voltage drop	3.5V max.
Response time	On + off <1ms
Switching logic	SPST, Normally open
Operating temperature	-10° to +70° C
Shock	30 G
Vibration	9 G
Protection circuit	None
Type of protection	IEC 529, IP67
Colour of LED	Green
Cable	Ø4, 2C, 2meter

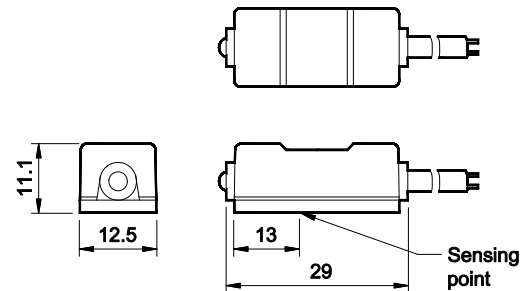

Cylinder bore Ø	X	Y	Ordering no. for Clamp (a)	Ordering no. Reed Switch (b)	Ordering no. (a+b)
32	37	29	SA0001	880006	AM1032
40	40	31			AM1063
50	44	37	SA0002		AM1080
63	45	48	SA0003		
80	57	-			
100	65	-			

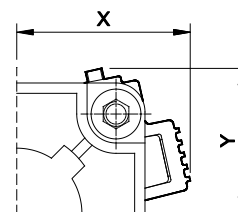

#### Circuit and connect diagram

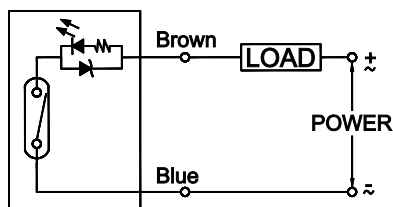

# AIR CYLINDER

Series A12, A13

Cat No A12, A13 - 01 - 03

## How to order

Model		Cylinder bore (mm)		Stroke (mm)		Mountings	
12	Standard cylinder	032	- Ø 32	025	- 25	O	- Basic
13	Magnetic cylinder	040	- Ø 40	050	- 50	L	- Foot Mounting
		050	- Ø 50	080	- 80	F	- Front Flange
		063	- Ø 63	100	- 100	R	- Rear Flange
		080	- Ø 80	125	- 125	S	- Male Clevis
		100	- Ø 100	160	- 160	D	- Female Clevis
				200	- 200	N	- Front Trunnion
				250	- 250	M	- Rear Trunnion
				300	- 300	T	- Center Trunnion
				320	- 320		
				400	- 400		
				500	- 500		

### Example:

Ordering no. for standard cylinder with 40 dia bore, 50 mm stroke with female clevis mounting : **A12 040 050 D**





### Note:

If ordered as 40 dia, 50 mm stroke cylinder, Basic cylinder **A12 040 050 O** will be supplied.

For repeat order when the details are taken from cylinder nameplate, mention the mounting style separately.

For ordering **Accessories** refer corresponding tables for part numbers.

For ordering individual **Mounting** kits ( If needed separately ) the order numbers are as below

Cylinder bore Ø	Foot mounting *	Front / Rear flange *	Male clevis *	Female clevis *	Front / Rear trunnion *
					
32	ML1032	MF1032	MS032	MD032	MT0032
40	ML040	MF040	MS040	MD040	MT0040
50	ML050	MF050	MS050	MD050	MT0050
63	ML063	MF063	MS063	MD063	MT0063
80	ML1080	MF1080	MS1080	MD1080	MT0080
100	ML1100	MF1100	MS1100	MD1100	MT0100

\* Supplied with 4nos. of screws

For your special requirements of cylinders or for further informations contact your regional dealer or **JANATICS**

Subject to change