

INDUSTRIAL HOSE & FITTINGS



ALFAGOMMA

Since 1956 ALFAGOMMA has been manufacturing and delivering top quality products all over the world.

ALFAGOMMA believe in the importance of offering an excellent service to all its customers along with a continuous new product research and development, a technical innovation and customized solutions, a constant high quality exceeding ISO 9001 quality standards and full compliance with ISO 14001 environmental norms, a global presence and logistic support a strong OEM expertise and customized solutions.



// MAIN PLANTS OVERVIEW

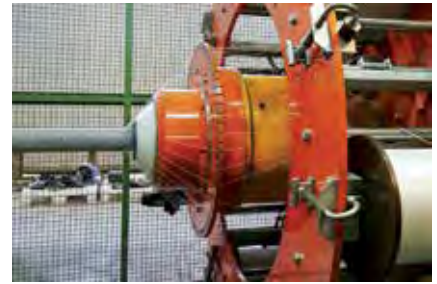

// CORE BUSINESS

ALFAGOMMA strategy is to be a single source integrated system supplier supporting its partners with a complete product range:

- Hydraulic Rubber & Thermoplastic Hose
- Fittings & Adapters
- Quick Release Couplings and Multi-K
- Swivel & Plug-in Connectors
- Hydraulic Hose Assemblies
- Manipulated Tubes
- Industrial Rubber, Thermoplastic & Composite Hose
- Industrial Stainless Steel Corrugated Hose
- Industrial Fittings
- Industrial Hose Assemblies

// GLOBAL PRESENCE AND LOGISTIC SUPPORT

The ALFAGOMMA Group currently employs over 3550 people worldwide in 20 Production Plants and 84 Regional Distribution – Assembly Centers strategically located in:



AMERICAS

- // Brazil
- // Canada
- // USA

AFRICA

- // South Africa

EUROPE

- // Italy
- // Denmark
- // Estonia
- // Finland
- // France
- // Germany
- // Greece
- // Netherland
- // Norway
- // Sweden
- // UK

ASIA & PACIFIC

- // Australia
- // China
- // Indonesia
- // Malaysia
- // Singapore
- // South Korea

// ICONS



Minimum Bend Radius =
2 x Internal Diameter



Oil resistance



2004/1935 EC
2006/2023 EC



Minimum Bend Radius =
3 x Internal Diameter



Electrical resistance along
the conductive layers
 $\leq 10^6 \Omega/\text{length}$



Phthalate Free



Top tube abrasion
resistance



Electrical resistance
through the hose wall
 $\leq 10^9 \Omega$



IANESCO approved



Premium tube abrasion
resistance



High performance product



LLOYD'S approved



Low temperature resistance



Extruded tube



MSHA approved



High temperature
resistance

// SYMBOLS



Internal Diameter



Maximum Working
Pressure



Vacuum

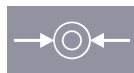

Outside Diameter



Minimum Burst
Pressure



Weight



Minimum Bend Radius

// INDUSTRIAL HOSE..... 9



REACH

ALFAGOMMA industrial hoses fully comply with REACH Regulation concerning the Registration, Evaluation, Authorization and restriction of Chemicals. They are totally free from any Substance of Very High Concern (SVHC).

// INDUSTRIAL FITTINGS..... 149



// APPENDIX

- // CHEMICAL RESISTANCE CHART 308**
- // PVC CHEMICAL RESISTANCE CHART 322**
- // INDUSTRIAL FITTINGS MANUAL..... 324**
- // INDUSTRIAL HOSE & RACOMMENDED FITTING TABLES 351**



NOTE: Since ALFAGOMMA continually examines ways to improve products, we reserve the right to alter specifications without prior notice. Weights and dimensions are nominal. Working pressures and vacuum ratings for hose are based at ambient temperature of 20 °C (68 °F). Pictures shown are for illustration purpose only. Actual hose construction might be different. Refer to local price list for items available in the different sales area, included available lengths and stock lengths.

// MANDREL

132AE	28	341AA	66	605AH	113	720LG	84
140AK	27	341AH	66	606AE	113	737AA	97
141AA	142	343AH	65	60DAA	125	740AA	98
142AK	27	344AH	65	60GAA	126	741AA	98
146AK	142	345AA	66	60NAA	126	748AA	134
151AA	140	350AA	63	60PAA	127	752AA	94
151AK	140	350LE	62	611AA	117	753AA	91
155AA	26	350LL	62	612AA	147	753AG	92
155AK	26	351LG	61	614AA	118	753AH	91
157AK	141	351LL	61	615AA	132	754AA	97
160AA	29	352AA	60	619AA	114	755AA	92
202AA	46	354AA	63	620AA	115	756AA	145
202LL	120	402LH	72	622AA	133	757AA	94
203AL	56	405LE	76	629AA	113	758AA	95
204AA	46	405LH	77	648AA	132	760AA	87
212AA	54	405LL	76	64AAA	125	760LA	83
221AA	47	410LL	73	64DAA	127	760LB	83
222AA	48	412LE	74	64PAA	128	765AA	145
223AA	47	415LI	135	650AA	110	766AA	87
225AA	144	417LE	77	650AB	111	776AA	146
240AA	143	418LE	74	650AH	110	776HA	146
241AA	143	448LI	135	653AA	121	902AA	32
245AA	144	452LH	72	655AA	114	902AE	32
248AE	49	455LE	75	656AA	117	902LE	33
250AA	39	455LL	75	658AA	115	903LE	33
251AA	54	503AA	103	659AA	116	906AA	130
253AA	39	505OG	103	6E1AA	122	949AA	85
254AA	40	509OE	104	702AA	52	952AA	31
254AH	40	519OE	105	706AA	145	954AH	101
254AL	56	529AA	104	714HA	146	956AB	102
256AA	40	538AA	105	715AA	134	957LL	57
340AA	64	601AA	112	720AA	88	962LA	31
340AH	64	605AA	112,123	720LA	84	964AA	147

// LONG LENGTH

071AI	19	081AH	16	180AA	23	671AA	109
071EH	19	088AI	16	185AA	23	680AA	109
071EI	19	165AA	29	185AH	24	687AA	108
076AE	17	166AA	29	185AK	24	688AA	108
076AH	17	175AA	25	186AA	24	689AA	108
076AI	17	175AH	25	283AA	54	974AH	100
076EH	18	175AK	25	284AA	37	975AH	101
076EI	18	179AA	28	284AH	37	976AB	102
081AE	16	179AB	28	375AA	60	984AH	100

// THERMOPLASTIC PRESSURE

189AK	141	286EE	38	395BT	61	591AE	51
191AK	22	288HH	38	490OO	36	593AK	51
195AT	22	289GG	143	492OO	36,70		

// THERMOPLASTIC SUCTION

161BL	11	178AA	12	266OL	42	472OO	45,71
163AL	11	264GL	41	267BE	43	668EL	111
171OO	13	265TH	43	268BL	44	764OL	94
172OO	13	266GL	41	268LL	48	767AL	88
173OO	14	266KL	42	269BA	44	780AA	89
174BB	12	266LL	120	466OL	70	967OE	85
177OO	14	266OA	52	468OH	71		



// INDUSTRIAL HOSE

// DUCTING & VENTILATION.....	10
// GAS & WELDING	15
// COMPRESSED AIR	21
// HOT AIR.....	30
// WATER & LIQUIDS.....	35
// AGRICULTURE.....	50
// FIRE FIGHTING.....	53
// FURNACE & CABLE COOLING.....	55
// HOT WATER & STEAM.....	59
// LIQUID FOOD	69
// BULK FOOD.....	82
// BULK MATERIAL	86
// SANDBLAST	90
// PLASTER	93
// CONCRETE.....	96
// ACID CHEMICAL & MULTIPURPOSE.....	99
// HYDROCARBONS	107
// MARINE	119
// DOCK.....	124
// RIG SUPPLY	131
// MINING	139



// DUCTING & VENTILATION



161BL	Air ducting - UL 94 V2.....	11
163AL	General purpose.....	11
174BB	Air ducting - High temperature +100 °C (+212 °F) - UL 94 V0.....	12
178AA	Air ducting - High temperature +120 °C (+248 °F).....	12
17100	Air ducting - Polyurethane - Gauge 0,4 mm.....	13
17200	Air ducting - Polyurethane - Gauge 0,8 mm.....	13
17300	Air ducting - Polyurethane - Gauge 1,2 mm.....	14
17700	Air ducting - Polyurethane - Gauge 1,7 mm.....	14

Dimensions shown may be changed without prior notice

// 161BL



**Air ducting
UL 94 V2**

Construction: grey PVC - abrasion and ozone resistant.
Reinforcement: white shock resistant rigid PVC.
Application: air, gas, fumes extraction. Air conditioning-ventilation.
Constant operation: -10 °C +60 °C (+14 °F +140 °F)

↔		↔		↻		↻		⤴		⚖		
mm	in	mm	in	bar	psi	bar	psi	mm	in	%	kg/m	lb/ft
20,0	13/16"							20,0	0,79	50	0,130	0,09
25,0	1"							25,0	0,98	50	0,170	0,12
32,0	1 1/4"							32,0	1,26	50	0,230	0,16
35,0	1 3/8"							35,0	1,38	50	0,250	0,17
40,0	1 9/16"							40,0	1,57	40	0,300	0,21
45,0	1 3/4"							45,0	1,77	40	0,350	0,24
51,0	2"							51,0	2,01	40	0,440	0,30
63,0	2 1/2"							63,0	2,48	40	0,560	0,38
70,0	2 3/4"							70,0	2,76	40	0,630	0,43
76,0	3"							76,0	2,99	40	0,700	0,48
80,0	3 1/8"							80,0	3,15	40	0,760	0,52
90,0	3 1/2"							90,0	3,54	40	0,850	0,58
102,0	4"							102,0	4,02	40	0,990	0,67
110,0	4 5/16"							110,0	4,33	40	1,100	0,74
120,0	4 3/4"							120,0	4,72	40	1,200	0,81
127,0	5"							127,0	5,00	40	1,270	0,86
140,0	5 1/2"							140,0	5,51	35	1,450	0,98
152,0	6"							152,0	5,98	35	1,700	1,15
160,0	6 5/16"							160,0	6,30	35	1,850	1,25
180,0	7 1/16"							180,0	7,09	30	2,200	1,48
203,0	8"							203,0	7,99	30	2,450	1,65
254,0	10"							254,0	10,00	10	3,200	2,16
305,0	12"							305,0	12,01	10	3,900	2,63

// 163AL



General purpose

Construction: black PVC - abrasion and ozone resistant.
Reinforcement: white shock resistant rigid PVC.
Application: general purpose designed for gas vent, air seeder and marine bilge pump applications - ID 51 mm according to AS 1425/2.22.
Constant operation: -10 °C +60 °C (+14 °F +140 °F)

↔		↔		↻		↻		⤴		⚖		
mm	in	mm	in	bar	psi	bar	psi	mm	in	%	kg/m	lb/ft
25,0	1"							25,0	0,98	50	0,230	0,16
28,0	1 1/8"							28,0	1,10	50	0,250	0,17
32,0	1 1/4"							32,0	1,26	50	0,300	0,21
38,0	1 1/2"							38,0	1,50	50	0,380	0,26
51,0	2"							102,0	4,02	50	0,700	0,48

// 174BB



**Air ducting - High temperature +100 °C (+212 °F)
UL 94 V0**

Construction: textile fabric coated with flame resistant PVC.
Reinforcement: steel helix wire.

Application: hot air, gas, fumes extraction. Air conditioning-ventilation.

Constant operation: -20 °C +100 °C (-4 °F +212 °F)

↔		↔		↻		↻		↵		⚖		
mm	in	mm	in	bar	psi	bar	psi	mm	in	%	kg/m	lb/ft
40,0	1 9/16"							20,0	0,79		0,110	0,08
51,0	2"							25,0	0,98		0,135	0,10
63,0	2 1/2"							30,0	1,18		0,170	0,12
70,0	2 3/4"							35,0	1,38		0,185	0,13
76,0	3"							40,0	1,57		0,200	0,14
80,0	3 1/8"							40,0	1,57		0,210	0,15
90,0	3 1/2"							45,0	1,77		0,240	0,17
102,0	4"							50,0	1,97		0,280	0,19
120,0	4 3/4"							60,0	2,36		0,325	0,22
127,0	5"							63,0	2,48		0,345	0,24
140,0	5 1/2"							70,0	2,76		0,380	0,26
152,0	6"							75,0	2,95		0,410	0,28
160,0	6 5/16"							80,0	3,15		0,425	0,29
180,0	7 1/16"							90,0	3,54		0,475	0,32
203,0	8"							100,0	3,94		0,535	0,36
254,0	10"							125,0	4,92		0,845	0,57
305,0	12"							150,0	5,91		1,010	0,68

// 178AA



Air ducting - High temperature +120 °C (+248 °F)

Construction: black EPDM/PP fully recyclable and halogens/ phthalates free.

Reinforcement: steel helix wire.

Application: hot air, gas, fumes extraction-ventilation where high temperature resistance is required.

Constant operation: -40 °C +120 °C (-40 °F +248 °F)

↔		↔		↻		↻		↵		⚖		
mm	in	mm	in	bar	psi	bar	psi	mm	in	%	kg/m	lb/ft
40,0	1 9/16"							32,0	1,26		0,200	0,14
51,0	2"							40,0	1,57		0,250	0,17
63,0	2 1/2"							55,0	2,17		0,310	0,21
70,0	2 3/4"							60,0	2,36		0,440	0,30
76,0	3"							65,0	2,56		0,460	0,31
80,0	3 1/8"							65,0	2,56		0,500	0,34
90,0	3 1/2"							75,0	2,95		0,580	0,39
102,0	4"							85,0	3,35		0,610	0,41
110,0	4 5/16"							90,0	3,54		0,660	0,45
120,0	4 3/4"							100,0	3,94		0,720	0,49
127,0	5"							105,0	4,13		0,830	0,56
140,0	5 1/2"							115,0	4,53		0,940	0,64
152,0	6"							125,0	4,92		1,010	0,68
160,0	6 5/16"							130,0	5,12		1,090	0,74
180,0	7 1/16"							150,0	5,91		1,330	0,90
203,0	8"							165,0	6,50		1,480	1,00
254,0	10"							210,0	8,27		1,930	1,30
305,0	12"							250,0	9,84		2,380	1,60
355,0	14"							300,0	11,81		2,770	1,87
406,0	16"							350,0	13,78		3,210	2,16

Dimensions shown may be changed without prior notice

// 17100



Air ducting - Polyurethane - Gauge 0,4 mm

Construction: transparent polyurethane - abrasion and ozone resistant.

Reinforcement: copper plated steel helix wire.

Application: air, gas, fumes extraction-ventilation. Also suitable for abrasive material suction - good oil mist resistance.

Constant operation: -40 °C +85 °C (-40 °F +185 °F)

↔		↔		↻		↻		⤴		⚖		
mm	in	mm	in	bar	psi	bar	psi	mm	in	%	kg/m	lb/ft
40,0	1 9/16"							44,0	1,73	35	0,170	0,12
51,0	2"							55,0	2,17	25	0,220	0,15
63,0	2 1/2"							67,0	2,64	25	0,270	0,19
70,0	2 3/4"							74,0	2,91	25	0,280	0,19
76,0	3"							80,0	3,15	25	0,350	0,24
80,0	3 1/8"							84,0	3,31	20	0,370	0,25
90,0	3 1/2"							94,0	3,70	20	0,420	0,29
102,0	4"							106,0	4,17	10	0,470	0,32
110,0	4 5/16"							114,0	4,49	10	0,510	0,35
120,0	4 3/4"							124,0	4,88	10	0,550	0,37
127,0	5"							132,0	5,20	10	0,750	0,51
140,0	5 1/2"							145,0	5,71	10	0,830	0,56
152,0	6"							157,0	6,18	10	0,900	0,61
160,0	6 5/16"							165,0	6,50	6	0,940	0,64
180,0	7 1/16"							185,0	7,28	6	1,060	0,72
203,0	8"							209,0	8,23	6	1,190	0,80
254,0	10"							260,0	10,24	2	1,960	1,32
305,0	12"							311,0	12,24	2	2,350	1,58
355,0	14"							362,0	14,25	2	2,700	1,82
406,0	16"							412,0	16,22	2	3,080	2,07

// 17200



Air ducting - Polyurethane - Gauge 0,8 mm

Construction: transparent polyurethane - abrasion and ozone resistant.

Reinforcement: copper plated steel helix wire.

Application: air, gas, fumes extraction-ventilation. Also suitable for abrasive material suction - good oil mist resistance.

Constant operation: -40 °C +85 °C (-40 °F +185 °F)

↔		↔		↻		↻		⤴		⚖		
mm	in	mm	in	bar	psi	bar	psi	mm	in	%	kg/m	lb/ft
40,0	1 9/16"							46,0	1,81	55	0,310	0,21
51,0	2"							57,0	2,24	40	0,390	0,27
63,0	2 1/2"							69,0	2,72	25	0,480	0,33
76,0	3"							82,0	3,23	40	0,560	0,38
80,0	3 1/8"							88,0	3,46	35	0,590	0,40
102,0	4"							109,0	4,29	30	0,900	0,61
120,0	4 3/4"							127,0	5,00	30	1,040	0,70
127,0	5"							134,0	5,28	30	1,100	0,74
140,0	5 1/2"							147,0	5,79	30	1,210	0,82
152,0	6"							159,0	6,26	30	1,310	0,89
160,0	6 5/16"							167,0	6,57	25	1,380	0,93
180,0	7 1/16"							187,0	7,36	25	1,550	1,05
203,0	8"							210,0	8,27	25	2,150	1,45
254,0	10"							261,0	10,28	15	2,650	1,79
305,0	12"							312,0	12,28	15	3,180	2,14
315,0	12 3/8"							322,0	12,68	15	3,290	2,22

// 17300



Air ducting - Polyurethane - Gauge 1,2 mm

Construction: transparent polyurethane - abrasion and ozone resistant.

Reinforcement: copper plated steel helix wire.

Application: air, gas, fumes extraction-ventilation. Also suitable for abrasive material suction - good oil mist resistance.

Constant operation: -40 °C +85 °C (-40 °F +185 °F)

↔		↔		↻		↻		⤴		⚖		
mm	in	mm	in	bar	psi	bar	psi	mm	in	%	kg/m	lb/ft
51,0	2"							71,0	2,80	60	0,610	0,41
63,0	2 1/2"							85,0	3,35	60	0,750	0,51
76,0	3"							101,0	3,98	60	0,870	0,59
80,0	3 1/8"							106,0	4,17	50	0,920	0,62
102,0	4"							133,0	5,24	40	1,360	0,92
152,0	6"							193,0	7,60	40	2,010	1,36
203,0	8"							254,0	10,00	30	2,680	1,81
254,0	10"							313,0	12,32	25	3,350	2,26
305,0	12"							374,0	14,72	25	4,010	2,70
355,0	14"							437,0	17,20	25	4,600	3,10

// 17700



Air ducting - Polyurethane - Gauge 1,7 mm

Construction: transparent polyurethane - abrasion and ozone resistant.

Reinforcement: copper plated steel helix wire.

Application: air, gas, fumes extraction-ventilation. Also suitable for abrasive material suction - good oil mist resistance.

Constant operation: -40 °C +85 °C (-40 °F +185 °F)

↔		↔		↻		↻		⤴		⚖		
mm	in	mm	in	bar	psi	bar	psi	mm	in	%	kg/m	lb/ft
40,0	1 9/16"							75,0	2,95	80	0,630	0,43
51,0	2"							92,0	3,62	70	0,790	0,54
63,0	2 1/2"							110,0	4,33	70	0,970	0,66
76,0	3"							129,0	5,08	70	1,140	0,77
102,0	4"							170,0	6,69	50	1,710	1,15
127,0	5"							207,0	8,15	50	2,120	1,43
152,0	6"							245,0	9,65	50	2,540	1,71



// GAS & WELDING



081AE	Oxygen 20 bar (300 psi).....	16
081AH	Acetylene 20 bar (300 psi).....	16
088AI	LPG-natural gas 25 bar (375 psi).....	16
076AE	Oxygen welding 20 bar (300 psi) - EN ISO 3821.....	17
076AH	Acetylene welding 20 bar (300 psi) - EN ISO 3821.....	17
076AI	LPG welding 20 bar (300 psi) - EN ISO 3821.....	17
076EH	Oxygen/acetylene twin welding 20 bar (300 psi) - EN ISO 3821.....	18
076EI	Oxygen/LPG twin welding 20 bar (300 psi) - EN ISO 3821.....	18
071AI	LPG welding 12 bar (180 psi).....	19
071EH	Oxygen/acetylene twin welding 12 bar (180 psi) - AS 1335.....	19
071EI	Oxygen/LPG twin welding 12 bar (180 psi) - AS 1335.....	19

// 081AE



Oxygen 20 bar (300 psi)

Tube: black synthetic elastomer.
Reinforcement: high tensile textile cords.
Cover: blue synthetic elastomer - abrasion and ozone resistant.
Application: oxygen.
Constant operation: -10 °C +60 °C (+14 °F +140 °F)

↔		↔		↙		↘		⤴		⚠	⚖	
mm	in	mm	in	bar	psi	bar	psi	mm	in	%	kg/m	lb/ft
6,0	1/4"	13,00	0,51	20	300	60	900	48,0	1,89		0,140	0,10
8,0	5/16"	15,00	0,59	20	300	60	900	64,0	2,52		0,170	0,12
10,0	3/8"	17,00	0,67	20	300	60	900	80,0	3,15		0,205	0,14

// 081AH



Acetylene 20 bar (300 psi)

Tube: black synthetic elastomer.
Reinforcement: high tensile textile cords.
Cover: red synthetic elastomer - abrasion and ozone resistant.
Application: acetylene.
Constant operation: -10 °C +60 °C (+14 °F +140 °F)

↔		↔		↙		↘		⤴		⚠	⚖	
mm	in	mm	in	bar	psi	bar	psi	mm	in	%	kg/m	lb/ft
6,0	1/4"	13,00	0,51	20	300	60	900	48,0	1,89		0,140	0,10
8,0	5/16"	15,00	0,59	20	300	60	900	64,0	2,52		0,170	0,12
10,0	3/8"	17,00	0,67	20	300	60	900	80,0	3,15		0,205	0,14

// 088AI



LPG-natural gas 25 bar (375 psi)

Tube: black synthetic elastomer.
Reinforcement: high tensile textile cords.
Cover: orange synthetic elastomer - abrasion and ozone resistant.
Application: LPG-natural gas.
Constant operation: -10 °C +60 °C (+14 °F +140 °F)

↔		↔		↙		↘		⤴		⚠	⚖	
mm	in	mm	in	bar	psi	bar	psi	mm	in	%	kg/m	lb/ft
8,0	5/16"	15,00	0,59	25	375	75	1100	64,0	2,52		0,170	0,12
10,0	3/8"	17,00	0,67	25	375	75	1100	80,0	3,15		0,200	0,14

Dimensions shown may be changed without prior notice

// 076AE



**Oxygen welding 20 bar (300 psi)
EN ISO 3821**

Tube: black SBR.
Reinforcement: high tensile textile cords.
Cover: blue SBR/EPDM - abrasion and ozone resistant.
Application: oxygen welding.
Constant operation: -25 °C +80 °C (-13 °F +176 °F)

↔		↔		↙		↘		⤴		⚖		
mm	in	mm	in	bar	psi	bar	psi	mm	in	%	kg/m	lb/ft
6,0	1/4"	13,00	0,51	20	300	60	900	80,0	3,15		0,170	0,12
8,0	5/16"	15,00	0,59	20	300	60	900	80,0	3,15		0,200	0,14
10,0	3/8"	17,00	0,67	20	300	60	900	100,0	3,94		0,240	0,17

// 076AH



**Acetylene welding 20 bar (300 psi)
EN ISO 3821**

Tube: black SBR.
Reinforcement: high tensile textile cords.
Cover: red SBR/EPDM - abrasion and ozone resistant.
Application: acetylene welding.
Constant operation: -25 °C +80 °C (-13 °F +176 °F)

↔		↔		↙		↘		⤴		⚖		
mm	in	mm	in	bar	psi	bar	psi	mm	in	%	kg/m	lb/ft
6,0	1/4"	13,00	0,51	20	300	60	900	80,0	3,15		0,170	0,12
8,0	5/16"	15,00	0,59	20	300	60	900	80,0	3,15		0,200	0,14
10,0	3/8"	17,00	0,67	20	300	60	900	100,0	3,94		0,240	0,17

// 076AI



**LPG welding 20 bar (300 psi)
EN ISO 3821**

Tube: black NBR.
Reinforcement: high tensile textile cords.
Cover: orange SBR/EPDM - abrasion and ozone resistant.
Application: LPG welding.
Constant operation: -30 °C +80 °C (-22 °F +176 °F)

↔		↔		↙		↘		⤴		⚖		
mm	in	mm	in	bar	psi	bar	psi	mm	in	%	kg/m	lb/ft
6,0	1/4"	13,00	0,51	20	300	60	900	80,0	3,15		0,160	0,11
8,0	5/16"	15,00	0,59	20	300	60	900	80,0	3,15		0,190	0,13
10,0	3/8"	17,00	0,67	20	300	60	900	100,0	3,94		0,220	0,15

// 076EH



Oxygen/acetylene twin welding 20 bar (300 psi)
EN ISO 3821

Tube: black SBR.
Reinforcement: high tensile textile cords.
Cover: blue, red SBR/EPDM - abrasion and ozone resistant.
Application: oxygen/acetylene twin welding.
Constant operation: -25 °C +80 °C (-13 °F +176 °F)

↔		↔		↻		↻		⤴		⚖		
mm	in	mm	in	bar	psi	bar	psi	mm	in	%	kg/m	lb/ft
6,0	1/4"	13,00	0,51	20	300	60	900	80,0	3,15		0,360	0,25
8,0	5/16"	15,00	0,59	20	300	60	900	80,0	3,15		0,410	0,28
10,0	3/8"	17,00	0,67	20	300	60	900	100,0	3,94		0,500	0,34

// 076EI



Oxygen/LPG twin welding 20 bar (300 psi)
EN ISO 3821

Tube: black SBR.
Reinforcement: high tensile textile cords.
Cover: blue, orange SBR/EPDM - abrasion and ozone resistant.
Application: oxygen/LPG twin welding.
Constant operation: -30 °C +80 °C (-22 °F +176 °F)

↔		↔		↻		↻		⤴		⚖		
mm	in	mm	in	bar	psi	bar	psi	mm	in	%	kg/m	lb/ft
8,0	5/16"	15,00	0,59	20	300	60	900	80,0	3,15		0,400	0,27

Dimensions shown may be changed without prior notice

// 071AI



**LPG welding 12 bar (180 psi)
AS 1335**

Tube: black NBR.
Reinforcement: high tensile textile cords.
Cover: orange SBR/EPDM - abrasion and ozone resistant.
Application: LPG welding.
Constant operation: -25 °C +80 °C (-13 °F +176 °F)

↔		↔		↻		↻		⤴		⚖		
mm	in	mm	in	bar	psi	bar	psi	mm	in	%	kg/m	lb/ft
5,0	3/16"	12,00	0,47	12	180	48	720	50,0	1,97		0,140	0,10

// 071EH



**Oxygen/acetylene twin welding 12 bar (180 psi)
AS 1335**

Tube: black SBR.
Reinforcement: high tensile textile cords.
Cover: blue, red SBR/EPDM - abrasion and ozone resistant.
Application: oxygen/acetylene twin welding.
Constant operation: -25 °C +80 °C (-13 °F +176 °F)

↔		↔		↻		↻		⤴		⚖		
mm	in	mm	in	bar	psi	bar	psi	mm	in	%	kg/m	lb/ft
5,0	3/16"	12,00	0,47	12	180	36	540	50,0			0,280	0,19

// 071EI



**Oxygen/LPG twin welding 12 bar (180 psi)
AS 1335**

Tube: black SBR-NBR.
Reinforcement: high tensile textile cords.
Cover: blue, orange SBR/EPDM - abrasion and ozone resistant.
Application: oxygen/LPG twin welding.
Constant operation: -25 °C +80 °C (-13 °F +176 °F)

↔		↔		↻		↻		⤴		⚖		
mm	in	mm	in	bar	psi	bar	psi	mm	in	%	kg/m	lb/ft
5,0	3/16"	12,00	0,47	12	180	48	720	50,0	1,97		0,280	0,19





195AT	Compressed air 20 bar (300 psi) - Polyurethane - Pneumatic tools.....	22
191AK	Compressed air 20 bar (300 psi) - PVC - exceeds AS/NZS 2554/B.....	22
180AA	Compressed air 20 bar (300 psi).....	23
185AA	Compressed air 20 bar (300 psi) - Standard duty - exceeds DIN 20018/1.....	23
185AH	Compressed air 20 bar (300 psi) - Standard duty.....	24
185AK	Compressed air 20 bar (300 psi) - Standard duty.....	24
186AA	Compressed air 20 bar (300 psi) - Heavy duty.....	24
175AA	Compressed air 20 bar (300 psi) - Standard duty.....	25
175AH	Compressed air 20 bar (300 psi) - Standard duty.....	25
175AK	Compressed air 20 bar (300 psi) - Standard duty.....	25
155AA	Compressed air 20 bar (300 psi) - Heavy duty.....	26
155AK	Compressed air 20 bar (300 psi) - Heavy duty.....	26
140AK	Compressed air - Steel braided.....	27
142AK	Compressed air 40 bar (600 psi) - High temperature - Oil resistant - Steel braided.....	27
132AE	Compressed air 80 bar (1200 psi) - High temperature - Steel braided.....	28
179AA	Push-loc/push-on.....	28
179AB	Push-loc/push-on.....	28
165AA	Air brake 10 bar (150 psi) - DIN 74310.....	29
166AA	Air brake 20 bar (300 psi) - SAE J1402.....	29
160AA	Railway air brake 20 bar (300 psi) - BS 3682/1 - AS 2435 - UIC 830-1/V.....	29

// 195AT



Compressed air 20 bar (300 psi) - Polyurethane - Pneumatic tools

Tube: black polyurethane/PVC - oil mist resistant.

Reinforcement: high tensile textile cords.

Cover: light blue synthetic elastomer - abrasion and ozone resistant.

Application: compressed air. Specially designed for pneumatic tools and paint spray.

Constant operation: -20 °C +60 °C (-4 °F +140 °F)

↔		↔		↻		↻		⤴		⚠	⚖	
mm	in	mm	in	bar	psi	bar	psi	mm	in	%	kg/m	lb/ft
6,0	1/4"	10,00	0,39	20	300	60	900	24,0	0,94		0,065	0,05
8,0	5/16"	12,00	0,47	20	300	60	900	32,0	1,26		0,080	0,06
10,0	3/8"	15,00	0,59	20	300	60	900	40,0	1,57		0,115	0,08
13,0	1/2"	19,00	0,75	20	300	60	900	52,0	2,05		0,185	0,13
16,0	5/8"	23,00	0,91	20	300	60	900	64,0	2,52		0,260	0,18
19,0	3/4"	26,00	1,02	20	300	60	900	76,0	2,99		0,305	0,21
25,0	1"	33,00	1,30	20	300	60	900	100,0	3,94		0,450	0,31

// 191AK



Compressed air 20 bar (300 psi) - PVC exceeds AS/NZS 2554/B

Tube: black PVC - oil mist resistant.

Reinforcement: high tensile textile cords.

Cover: yellow ribbed PVC with longitudinal blue stripes - abrasion and ozone resistant.

Application: compressed air and general industrial applications. Also suitable for crop spraying of fertilizers, pesticides and weed killers.

Constant operation: -5 °C +60 °C (+23 °F +140 °F)

↔		↔		↻		↻		⤴		⚠	⚖	
mm	in	mm	in	bar	psi	bar	psi	mm	in	%	kg/m	lb/ft
10,0	3/8"	16,00	0,63	20	300	64	960	80,0	3,15		0,170	0,12
13,0	1/2"	19,00	0,75	20	300	64	960	104,0	4,09		0,205	0,14
19,0	3/4"	27,00	1,06	20	300	64	960	152,0	5,98		0,370	0,25
25,0	1"	34,00	1,34	20	300	64	960	200,0	7,87		0,525	0,36

Dimensions shown may be changed without prior notice

// 180AA



Compressed air 20 bar (300 psi)

Tube: black synthetic elastomer - oil mist resistant.

Reinforcement: high tensile textile cords.

Cover: black synthetic elastomer - abrasion and ozone resistant.

Application: compressed air and general industrial applications.

Constant operation: -10 °C +60 °C (+14 °F +140 °F)

↔		↔		↻		↻		⤴		⚖		
mm	in	mm	in	bar	psi	bar	psi	mm	in	%	kg/m	lb/ft
13,0	1/2"	19,00	0,75	20	300	60	900	104,0	4,09		0,210	0,15
19,0	3/4"	27,00	1,06	20	300	60	900	152,0	5,98		0,405	0,28
25,0	1"	34,00	1,34	20	300	60	900	200,0	7,87		0,575	0,39

// 185AA



Compressed air 20 bar (300 psi) - Standard duty exceeds DIN 20018/1

Tube: black synthetic elastomer - oil mist resistant.

Reinforcement: high tensile textile cords.

Cover: black synthetic elastomer with longitudinal yellow stripes - abrasion and ozone resistant.

Application: compressed air and general industrial applications.

Constant operation: -10 °C +60 °C (+14 °F +140 °F)

↔		↔		↻		↻		⤴		⚖		
mm	in	mm	in	bar	psi	bar	psi	mm	in	%	kg/m	lb/ft
6,0	1/4"	12,00	0,47	20	300	60	900	48,0	1,89		0,120	0,09
8,0	5/16"	14,00	0,55	20	300	60	900	64,0	2,52		0,145	0,10
10,0	3/8"	17,00	0,67	20	300	60	900	80,0	3,15		0,205	0,14
13,0	1/2"	21,00	0,83	20	300	60	900	104,0	4,09		0,280	0,19
16,0	5/8"	24,00	0,94	20	300	60	900	128,0	5,04		0,350	0,24
19,0	3/4"	28,00	1,10	20	300	60	900	152,0	5,98		0,460	0,31
25,0	1"	35,00	1,38	20	300	60	900	200,0	7,87		0,645	0,44

// 185AH



Compressed air 20 bar (300 psi) - Standard duty

Tube: black synthetic elastomer - oil mist resistant.
Reinforcement: high tensile textile cords.
Cover: red synthetic elastomer - abrasion and ozone resistant.
Application: compressed air and general industrial applications.
Constant operation: -10 °C +60 °C (+14 °F +140 °F)

↔		↔		↻		↻		⤴		⚠	⚖	
mm	in	mm	in	bar	psi	bar	psi	mm	in	%	kg/m	lb/ft
6,0	1/4"	12,00	0,47	20	300	60	900	48,0	1,89		0,120	0,09
8,0	5/16"	14,00	0,55	20	300	60	900	64,0	2,52		0,145	0,10
10,0	3/8"	17,00	0,67	20	300	60	900	80,0	3,15		0,205	0,14
13,0	1/2"	21,00	0,83	20	300	60	900	104,0	4,09		0,280	0,19
19,0	3/4"	28,00	1,10	20	300	60	900	152,0	5,98		0,460	0,31
25,0	1"	35,00	1,38	20	300	60	900	200,0	7,87		0,645	0,44

// 185AK



Compressed air 20 bar (300 psi) - Standard duty

Tube: black synthetic elastomer - oil mist resistant.
Reinforcement: high tensile textile cords.
Cover: yellow synthetic elastomer - abrasion and ozone resistant.
Application: compressed air and general industrial applications.
Constant operation: -10 °C +60 °C (+14 °F +140 °F)

↔		↔		↻		↻		⤴		⚠	⚖	
mm	in	mm	in	bar	psi	bar	psi	mm	in	%	kg/m	lb/ft
13,0	1/2"	21,00	0,83	20	300	60	900	104,0	4,09		0,325	0,22
19,0	3/4"	28,00	1,10	20	300	60	900	152,0	5,98		0,460	0,31
25,0	1"	35,00	1,38	20	300	60	900	200,0	7,87		0,645	0,44

// 186AA



Compressed air 20 bar (300 psi) - Heavy duty

Tube: black synthetic elastomer - oil mist resistant.
Reinforcement: high tensile textile cords.
Cover: black synthetic elastomer - abrasion and ozone resistant.
Application: compressed air and general industrial applications.
Constant operation: -10 °C +60 °C (+14 °F +140 °F)

↔		↔		↻		↻		⤴		⚠	⚖	
mm	in	mm	in	bar	psi	bar	psi	mm	in	%	kg/m	lb/ft
6,0	1/4"	14,00	0,55	20	300	60	900	48,0	1,89		0,185	0,13
8,0	5/16"	17,00	0,67	20	300	60	900	64,0	2,52		0,255	0,18
10,0	3/8"	19,00	0,75	20	300	60	900	80,0	3,15		0,300	0,21
13,0	1/2"	23,00	0,91	20	300	60	900	104,0	4,09		0,415	0,28
19,0	3/4"	30,00	1,18	20	300	60	900	152,0	5,98		0,575	0,39
25,0	1"	37,00	1,46	20	300	60	900	200,0	7,87		0,775	0,53

Dimensions shown may be changed without prior notice

// 175AA



Compressed air 20 bar (300 psi) - Standard duty

Tube: black SBR/NBR - oil mist resistant.

Reinforcement: high tensile textile cords.

Cover: black SBR - abrasion and ozone resistant.

Application: compressed air and general industrial applications.

Constant operation: -25 °C +80 °C (-13 °F +176 °F)

↔		↔		↙		↘		↵		⚠	⚖	
mm	in	mm	in	bar	psi	bar	psi	mm	in	%	kg/m	lb/ft
6,0	1/4"	12,00	0,47	20	300	60	900	80,0	3,15		0,160	0,11
8,0	5/16"	14,00	0,55	20	300	60	900	80,0	3,15		0,170	0,12
10,0	3/8"	17,00	0,67	20	300	60	900	100,0	3,94		0,245	0,17
13,0	1/2"	21,00	0,83	20	300	60	900	110,0	4,33		0,350	0,24
16,0	5/8"	24,00	0,94	20	300	60	900	140,0	5,51		0,415	0,28
19,0	3/4"	28,00	1,10	20	300	60	900	160,0	6,30		0,520	0,35
25,0	1"	35,00	1,38	20	300	60	900	210,0	8,27		0,780	0,53

// 175AH



Compressed air 20 bar (300 psi) - Standard duty

Tube: black EPDM.

Reinforcement: high tensile textile cords.

Cover: red EPDM - abrasion and ozone resistant.

Application: compressed air and general industrial applications.

Constant operation: -30 °C +80 °C (-22 °F +176 °F)

↔		↔		↙		↘		↵		⚠	⚖	
mm	in	mm	in	bar	psi	bar	psi	mm	in	%	kg/m	lb/ft
6,0	1/4"	16,00	0,63	20	300	80	1200	48,0	1,89		0,240	0,17
8,0	5/16"	16,00	0,63	20	300	80	1200	64,0	2,52		0,210	0,15
10,0	3/8"	18,00	0,71	20	300	80	1200	80,0	3,15		0,270	0,19
13,0	1/2"	22,00	0,87	20	300	80	1200	104,0	4,09		0,370	0,25
16,0	5/8"	25,00	0,98	17	250	68	986	128,0	5,04		0,450	0,31
19,0	3/4"	29,00	1,14	17	250	68	986	152,0	5,98		0,570	0,39
25,0	1"	36,00	1,42	14	200	56	800	200,0	7,87		0,760	0,52

// 175AK



Compressed air 20 bar (300 psi) - Standard duty

Tube: black NBR/SBR - oil mist resistant.

Reinforcement: high tensile textile cords.

Cover: yellow NBR/PVC - abrasion and ozone resistant.

Application: compressed air and general industrial applications.

Constant operation: -25 °C +80 °C (-13 °F +176 °F)

↔		↔		↙		↘		↵		⚠	⚖	
mm	in	mm	in	bar	psi	bar	psi	mm	in	%	kg/m	lb/ft
10,0	3/8"	19,00	0,75	20	300	60	900	100,0	3,94		0,315	0,22
13,0	1/2"	23,00	0,91	20	300	60	900	110,0	4,33		0,435	0,30
19,0	3/4"	30,00	1,18	20	300	60	900	160,0	6,30		0,645	0,44
25,0	1"	37,00	1,46	20	300	60	900	210,0	8,27		0,890	0,60

// 155AA



Compressed air 20 bar (300 psi) - Heavy duty

Tube: black SBR/NBR - oil mist resistant.
Reinforcement: high tensile textile cords.
Cover: black SBR - abrasion and ozone resistant.
Application: compressed air designed for heavy duty applications.
Constant operation: -30 °C +80 °C (-22 °F +176 °F)

↔		↔		↻		↻		⤴		%	⚖	
mm	in	mm	in	bar	psi	bar	psi	mm	in		kg/m	lb/ft
19,0	3/4"	29,00	1,14	20	300	60	900				0,550	0,37
22,0	7/8"	32,00	1,26	20	300	60	900				0,620	0,42
25,0	1"	35,00	1,38	20	300	60	900				0,690	0,47
28,0	1 1/8"	38,00	1,50	20	300	60	900				0,790	0,54
30,0	1 3/16"	42,00	1,65	20	300	60	900				0,840	0,57
32,0	1 1/4"	44,00	1,73	20	300	60	900				0,880	0,60
35,0	1 3/8"	47,00	1,85	20	300	60	900				0,950	0,64
38,0	1 1/2"	50,00	1,97	20	300	60	900				1,030	0,70
40,0	1 9/16"	52,00	2,05	20	300	60	900				1,070	0,72
45,0	1 3/4"	57,00	2,24	20	300	60	900				1,200	0,81
48,0	1 7/8"	60,00	2,36	20	300	60	900				1,270	0,86
51,0	2"	63,00	2,48	20	300	60	900				1,330	0,90
51,0	2"	65,00	2,56	20	300	60	900				1,650	1,11
55,0	2 1/6"	69,00	2,72	20	300	50	730				1,760	1,19
60,0	2 3/8"	76,00	2,99	20	300	50	730				2,200	1,48
63,0	2 1/2"	79,00	3,11	20	300	50	730				2,290	1,54
76,0	3"	92,00	3,62	20	300	50	730				2,800	1,89
90,0	3 1/2"	106,00	4,17	20	300	50	730				3,240	2,18
102,0	4"	118,00	4,65	20	300	50	730				3,660	2,46
152,0	6"	170,00	6,69	20	300	50	730				6,220	4,19

// 155AK



Compressed air 20 bar (300 psi) - Heavy duty

Tube: black SBR/NBR - oil mist resistant.
Reinforcement: high tensile textile cords.
Cover: yellow SBR - abrasion and ozone resistant.
Application: compressed air designed for heavy duty applications.
Constant operation: -30 °C +80 °C (-22 °F +176 °F)

↔		↔		↻		↻		⤴		%	⚖	
mm	in	mm	in	bar	psi	bar	psi	mm	in		kg/m	lb/ft
13,0	1/2"	21,00	0,83	20	300	60	900				0,320	0,22
19,0	3/4"	29,00	1,14	20	300	60	900				0,550	0,37
25,0	1"	35,00	1,38	20	300	60	900				0,690	0,47
32,0	1 1/4"	44,00	1,73	20	300	60	900				0,890	0,60
38,0	1 1/2"	50,00	1,97	20	300	60	900				1,030	0,70
51,0	2"	65,00	2,56	20	300	60	900				1,660	1,12
63,0	2 1/2"	79,00	3,11	20	300	50	730				2,300	1,55
76,0	3"	92,00	3,62	20	300	50	730				2,810	1,89
102,0	4"	118,00	4,65	20	300	50	730				3,680	2,48

Dimensions shown may be changed without prior notice

// 140AK

**Compressed air - Steel braided****Tube:** black SBR - oil mist resistant.**Reinforcement:** one or two high tensile steel wire braids.**Cover:** yellow SBR - abrasion, ozone, hydrocarbon resistant - pin pricked.**Application:** high pressure compressed air designed for heavy duty mine and quarry applications where long service life and maximum safety is required.**Constant operation:** -30 °C +80 °C (-22 °F +176 °F)

↔		↔		↻		↻		⤴		⚖		
mm	in	mm	in	bar	psi	bar	psi	mm	in	%	kg/m	lb/ft
13,0	1/2"	22,00	0,87	40	600	160	2320	65,0	2,56		0,410	0,28
19,0	3/4"	28,00	1,10	40	600	160	2320	95,0	3,74		0,560	0,38
25,0	1"	34,00	1,34	40	600	160	2320	125,0	4,92		0,700	0,48
32,0	1 1/4"	42,00	1,65	40	600	160	2320	160,0	6,30		0,990	0,67
38,0	1 1/2"	48,00	1,89	40	600	160	2320	190,0	7,48		1,180	0,80
51,0	2"	64,00	2,52	40	600	160	2320	255,0	10,04		2,000	1,35
63,0	2 1/2"	77,00	3,03	30	450	120	1750	315,0	12,40		2,810	1,89
76,0	3"	90,00	3,54	30	450	120	1750	380,0	14,96		3,480	2,34
102,0	4"	118,00	4,65	30	450	120	1750	510,0	20,08		4,500	3,03

// 142AK

**Compressed air 40 bar (600 psi) - High temperature - Oil resistant - Steel braided****Tube:** black NBR (RMA Class A) - oil mist resistant.**Reinforcement:** high tensile steel wire braids.**Cover:** yellow SBR/NBR - abrasion, ozone, hydrocarbon and flame resistant - pin pricked.**Application:** high pressure compressed air designed for heavy duty mine and quarry applications where long service life and maximum safety is required.**Constant operation:** -40 °C +120 °C (-40 °F +248 °F)

↔		↔		↻		↻		⤴		⚖		
mm	in	mm	in	bar	psi	bar	psi	mm	in	%	kg/m	lb/ft
51,0	2"	64,00	2,52	40	600	160	2320	255,0	10,04		1,910	1,29
76,0	3"	90,00	3,54	40	600	120	1750	380,0	14,96		3,270	2,20

// 132AE



Compressed air 80 bar (1200 psi) - High temperature - Steel braided

Tube: black chlorobutyl - oil mist (maximum six parts per million) and high temperature resistant.

Reinforcement: high tensile steel wire braids.

Cover: blue EPDM - abrasion and ozone resistant - pin pricked.

Application: high pressure compressed air designed for heavy duty mine and quarry applications where long service life and maximum safety is required. Designed for use of EN 853 2ST fittings.

Constant operation: -40 °C +150 °C (-40 °F +300 °F) with peaks of 232 °C (450 °F)

↔		↔		↻		↻		⤴		⚠	⚖	
mm	in	mm	in	bar	psi	bar	psi	mm	in	%	kg/m	lb/ft
51,0	2"	67,00	2,64	80	1200	320	4640	255,0	10,04		2,620	1,77

// 179AA



Push-loc/push-on

Tube: black NBR/SBR - oil mist resistant.

Reinforcement: high tensile textile cords.

Cover: black SBR/CR - oil, abrasion and ozone resistant.

Application: "push-on" compressed air in automotive assembly lines and general industrial applications.

Constant operation: -20 °C +70 °C (-4 °F +158 °F)

↔		↔		↻		↻		⤴		⚠	⚖	
mm	in	mm	in	bar	psi	bar	psi	mm	in	%	kg/m	lb/ft
6,0	1/4"	12,00	0,47	20	300	80	1200	36,0	1,42		0,140	0,10
10,0	3/8"	16,00	0,63	20	300	80	1200	60,0	2,36		0,185	0,13
13,0	1/2"	19,00	0,75	20	300	80	1200	78,0	3,07		0,235	0,16
16,0	5/8"	23,00	0,91	20	300	80	1200	96,0	3,78		0,325	0,22
19,0	3/4"	26,00	1,02	20	300	80	1200	114,0	4,49		0,370	0,25

// 179AB



Push-loc/push-on

Tube: black NBR/SBR - oil mist resistant.

Reinforcement: high tensile textile cords.

Cover: grey SBR/CR - oil, abrasion and ozone resistant.

Application: "push-on" compressed air in automotive assembly lines and general industrial applications.

Constant operation: -20 °C +70 °C (-4 °F +158 °F)

↔		↔		↻		↻		⤴		⚠	⚖	
mm	in	mm	in	bar	psi	bar	psi	mm	in	%	kg/m	lb/ft
6,0	1/4"	12,00	0,47	20	300	80	1200	36,0	1,42		0,140	0,10
10,0	3/8"	16,00	0,63	20	300	80	1200	60,0	2,36		0,185	0,13
13,0	1/2"	19,00	0,75	20	300	80	1200	78,0	3,07		0,235	0,16
16,0	5/8"	23,00	0,91	20	300	80	1200	96,0	3,78		0,325	0,22

Dimensions shown may be changed without prior notice

// 165AA



**Air brake 10 bar (150 psi)
DIN 74310**

Tube: black EPDM.
Reinforcement: high tensile textile cords.
Cover: black EPDM - abrasion and ozone resistant.
Application: air brake hose.
Constant operation: -40 °C +100 °C (-40 °F +212 °F)

↔		↔		↕		↕		⤴		⚖		
mm	in	mm	in	bar	psi	bar	psi	mm	in	%	kg/m	lb/ft
11,0	7/16"	18,00	0,71	10	150	25	375	70,0	2,76		0,210	0,15
13,0	1/2"	25,00	0,98	10	150	25	375	100,0	3,94		0,470	0,32

// 166AA



**Air brake 20 bar (300 psi)
SAE J1402**

Tube: black NBR.
Reinforcement: high tensile textile cords.
Cover: black NBR - abrasion and ozone resistant.
Application: air brake hose.
Constant operation: -40 °C +100 °C (-40 °F +212 °F)

↔		↔		↕		↕		⤴		⚖		
mm	in	mm	in	bar	psi	bar	psi	mm	in	%	kg/m	lb/ft
9,5	3/8"	19,00	0,75	20	300	60	900	90,0	3,54		0,320	0,22
14,5	37/64"	25,50	1,00	20	300	60	900	115,0	4,53		0,515	0,35

// 160AA



**Railway air brake 20 bar (300 psi)
BS 3682/1 - AS 2435 - UIC 830-1/V**

Tube: black SBR/NBR - oil mist resistant.
Reinforcement: high tensile textile braids.
Cover: black SBR/NBR - abrasion and ozone resistant.
Application: railway air brake.
Constant operation: -25 °C +65 °C (-13 °F +150 °F)

↔		↔		↕		↕		⤴		⚖		
mm	in	mm	in	bar	psi	bar	psi	mm	in	%	kg/m	lb/ft
13,0	1/2"	25,00	0,98	20	300	80	1200				0,400	0,27
20,0	13/16"	34,00	1,34	20	300	80	1200				0,630	0,43
22,0	7/8"	36,00	1,42	20	300	80	1200				0,780	0,53
30,0	1 3/16"	46,00	1,81	20	300	80	1200				1,210	0,82
35,0	1 3/8"	53,00	2,09	20	300	80	1200				1,350	0,91



// HOT AIR



952AA	Hot air blower 10 bar (150 psi) - Soft wall - External textile braid.....	31
962LA	Hot air blower 10 bar (150 psi) - Soft wall.....	31
902AA	Hot air blower 10 bar (150 psi) - Hard wall.....	32
902AE	Hot air blower 10 bar (150 psi) - Hard wall.....	32
902LE	Hot air blower 10 bar (150 psi) - Hard wall.....	33
903LE	Hot air blower 10 bar (150 psi) - Hard wall - FDA.....	33

Dimensions shown may be changed without prior notice

// 952AA



Hot air blower 10 bar (150 psi) - Soft wall - External textile braid

Tube: black EPDM - heat resistant.
Reinforcement: high tensile textile braids.
Application: hot air connection from volumetric compressor to bulk food/material road tanker.
Constant operation: -40 °C +180 °C (-40 °F +356 °F)

↔		↔		↻		↻		↵		⚖		
mm	in	mm	in	bar	psi	bar	psi	mm	in	%	kg/m	lb/ft
51,0	2"	67,00	2,64	10	150	30	450	255,0	10,04		1,580	1,07
76,0	3"	92,00	3,62	10	150	30	450	380,0	14,96		2,340	1,58

// 962LA



Hot air blower 10 bar (150 psi) - Soft wall

Tube: white EPDM - heat resistant.
Reinforcement: high tensile textile cords.
Cover: black EPDM - heat, abrasion and ozone resistant.
Application: hot air connection from volumetric compressor to bulk food/material road tanker.
Constant operation: -40 °C +180 °C (-40 °F +356 °F)

↔		↔		↻		↻		↵		⚖		
mm	in	mm	in	bar	psi	bar	psi	mm	in	%	kg/m	lb/ft
51,0	2"	69,00	2,72	10	150	30	450	306,0	12,05		2,580	1,74
76,0	3"	94,00	3,70	10	150	30	450	456,0	17,95		3,490	2,35

// 902AA



Hot air blower 10 bar (150 psi) - Hard wall

Tube: black EPDM - heat resistant.

Reinforcement: high tensile textile cords with embedded steel helix wire.

Cover: black EPDM - heat, abrasion and ozone resistant.

Application: hot air connection from volumetric compressor to bulk food/material road tanker. Special light weight and flexible construction.

Constant operation: -40 °C +180 °C (-40 °F +356 °F)

↔		↔		↻		↻		⤴		⌒		⚖	
mm	in	mm	in	bar	psi	bar	psi	mm	in	%	kg/m	lb/ft	
51,0	2"	63,00	2,48	10	150	30	450	153,0	6,02	100	1,510	1,02	
63,0	2 1/2"	77,00	3,03	10	150	30	450	189,0	7,44	100	2,000	1,35	
76,0	3"	90,00	3,54	10	150	30	450	228,0	8,98	90	2,400	1,62	
102,0	4"	116,00	4,57	10	150	30	450	306,0	12,05	90	3,330	2,24	

// 902AE



Hot air blower 10 bar (150 psi) - Hard wall

Tube: black EPDM - heat resistant.

Reinforcement: high tensile textile cords with embedded steel helix wire.

Cover: blue EPDM - heat, abrasion and ozone resistant.

Application: hot air connection from volumetric compressor to bulk food/material road tanker. Special light weight and flexible construction.

Constant operation: -40 °C +180 °C (-40 °F +356 °F)

↔		↔		↻		↻		⤴		⌒		⚖	
mm	in	mm	in	bar	psi	bar	psi	mm	in	%	kg/m	lb/ft	
76,0	3"	90,00	3,54	10	150	30	450	228,0	8,98	90	2,310	1,56	

Dimensions shown may be changed without prior notice

// 902LE

**Hot air blower 10 bar (150 psi) - Hard wall****Tube:** white EPDM - heat resistant.**Reinforcement:** high tensile textile cords with embedded steel helix wire.**Cover:** blue EPDM - heat, abrasion and ozone resistant.**Application:** hot air connection from volumetric compressor to bulk food/material road tanker. Special light weight and flexible construction.**Constant operation:** -40 °C +180 °C (-40 °F +356 °F)

↔		↔		↻		↻		⤴		⏪		⏺	
mm	in	mm	in	bar	psi	bar	psi	mm	in	%	kg/m	lb/ft	
51,0	2"	63,00	2,48	10	150	30	450	153,0	6,02	100	1,560	1,05	
53,0	2 1/16"	65,00	2,56	10	150	30	450	159,0	6,26	100	1,610	1,09	
63,0	2 1/2"	77,00	3,03	10	150	30	450	189,0	7,44	90	2,380	1,60	
76,0	3"	90,00	3,54	10	150	30	450	228,0	8,98	90	2,840	1,91	
90,0	3 1/2"	104,00	4,09	10	150	30	450	270,0	10,63	90	3,520	2,37	

// 903LE

**Hot air blower 10 bar (150 psi) - Hard wall
FDA****Tube:** white EPDM - heat resistant.**Reinforcement:** high tensile textile cords with embedded steel helix wire.**Cover:** blue EPDM - heat, abrasion and ozone resistant.**Application:** hot air connection from volumetric compressor to bulk food/material road tanker. Special light weight and flexible construction.**Constant operation:** -40 °C +180 °C (-40 °F +356 °F)

↔		↔		↻		↻		⤴		⏪		⏺	
mm	in	mm	in	bar	psi	bar	psi	mm	in	%	kg/m	lb/ft	
38,0	1 1/2"	50,00	1,97	10	150	30	450	114,0	4,49	100	1,140	0,77	
51,0	2"	63,00	2,48	10	150	30	450	153,0	6,02	100	1,470	0,99	
76,0	3"	90,00	3,54	10	150	30	450	228,0	8,98	90	2,670	1,80	
102,0	4"	116,00	4,57	10	150	30	450	306,0	12,05	90	3,630	2,44	
127,0	5"	145,00	5,71	10	150	30	450	445,0	17,52	80	6,060	4,08	





4900O	General purpose tubing - PVC - FDA.....	36
4920O	General purpose food quality - PVC - FDA - EU 10/2011 A+B+C - AS 2070.....	36
284AA	Water delivery 10 bar (150 psi).....	37
284AH	Water delivery 10 bar (150 psi).....	37
286EE	Water discharge - PVC - Lay flat - Standard duty.....	38
288HH	Water discharge - PVC - Lay flat - Heavy duty.....	38
250AA	Water discharge 5 bar (75 psi) - Lay flat.....	39
253AA	Water discharge 10 bar (150 psi) - Lay flat.....	39
254AA	Air-water delivery 10 bar (150 psi).....	40
254AH	Air-water delivery 10 bar (150 psi).....	40
256AA	Water-irrigation 18 bar (270 psi) - Heavy duty.....	40
264GL	Water S&D - PVC - Light duty.....	41
266GL	Water S&D - PVC - Standard duty.....	41
266KL	Water S&D - PVC - Standard duty.....	42
266OL	Water S&D - PVC - Standard duty - Super elastic.....	42
265TH	Water-slurry S&D - PVC - Standard duty - Super elastic.....	43
267BE	Water-slurry S&D - PVC - Medium duty - Super elastic.....	43
269BA	Water-slurry S&D - PVC/NBR - Medium duty - Superior flexibility.....	44
268BL	Water-abrasive slurry S&D - PVC - Heavy duty.....	44
4720O	General purpose food quality S&D - PVC - FDA - EU 10/2011 A+B+C - AS 2070.....	45
204AA	Water S&D 5 bar (75 psi).....	46
202AA	General purpose S&D 10 bar (150 psi) - EPDM.....	46
223AA	Water S&D 20 bar (300 psi) - Heavy duty.....	47
221AA	Water-slurry S&D - Corrugated - Soft ends.....	47
222AA	Heavy duty dewatering - EPDM - Corrugated - Soft ends.....	48
268LL	Pools-spa water circulation.....	48
248AE	High pressure water delivery 100 bar (1500 psi) - Snow maker - Steel braided.....	49

// 49000



**General purpose tubing - PVC
FDA**

Tube: transparent PVC.

Application: general purpose. Sterilize with 5% soda solution.

Constant operation: -5 °C +60 °C (+23 °F +140 °F)

↔		↔		↕		↕		⌒		⚠	⚖	
mm	in	mm	in	bar	psi	bar	psi	mm	in	%	kg/m	lb/ft
3,0	1/8"	5,00	0,20								0,015	0,02
4,0	5/32"	6,00	0,24								0,020	0,02
5,0	3/16"	8,00	0,31								0,040	0,03
6,0	1/4"	9,00	0,35								0,045	0,04
7,0	9/32"	11,00	0,43								0,070	0,05
8,0	5/16"	12,00	0,47								0,080	0,06
10,0	3/8"	14,00	0,55								0,095	0,07
12,0	15/32"	16,00	0,63								0,110	0,08
14,0	9/16"	19,00	0,75								0,160	0,11
16,0	5/8"	22,00	0,87								0,220	0,15
18,0	23/32"	24,00	0,94								0,245	0,17
20,0	13/16"	26,00	1,02								0,265	0,18
22,0	7/8"	28,00	1,10								0,290	0,20
25,0	1"	32,00	1,26								0,415	0,28

// 49200



**General purpose food quality - PVC
FDA - EU 10/2011 A+B+C - AS 2070**

Tube: transparent PVC.

Reinforcement: high tensile textile cords.

Cover: transparent PVC with longitudinal red stripes - abrasion and ozone resistant.

Application: general purpose food quality. Sterilize with 5% soda solution.

Constant operation: -5 °C +60 °C (+23 °F +140 °F)

↔		↔		↕		↕		⌒		⚠	⚖	
mm	in	mm	in	bar	psi	bar	psi	mm	in	%	kg/m	lb/ft
6,0	1/4"	11,00	0,43	20	300	60	900				0,085	0,06
6,0	1/4"	12,00	0,47	20	300	60	900				0,110	0,08
8,0	5/16"	13,00	0,51	15	225	45	650				0,105	0,08
8,0	5/16"	14,00	0,55	15	225	45	650				0,130	0,09
10,0	3/8"	15,00	0,59	15	225	45	650				0,125	0,09
10,0	3/8"	16,00	0,63	15	225	45	650				0,155	0,11
13,0	1/2"	19,00	0,75	10	150	30	450				0,190	0,13
16,0	5/8"	22,00	0,87	10	150	30	450				0,225	0,16
19,0	3/4"	25,00	0,98	10	150	30	450				0,260	0,18
19,0	3/4"	26,00	1,02	10	150	30	450				0,310	0,21
25,0	1"	32,00	1,26	10	150	30	450				0,390	0,27
25,0	1"	33,00	1,30	10	150	30	450				0,450	0,31
30,0	1 3/16"	38,00	1,50	7	100	21	300				0,530	0,36
32,0	1 1/4"	42,00	1,65	7	100	21	300				0,715	0,49
38,0	1 1/2"	48,00	1,89	7	100	21	300				0,830	0,56
51,0	2"	63,00	2,48	6	90	18	270				1,330	0,90

Dimensions shown may be changed without prior notice

// 284AA



Water delivery 10 bar (150 psi)

Tube: black synthetic elastomer - oil mist resistant.

Reinforcement: high tensile textile cords.

Cover: black synthetic elastomer with longitudinal green stripes - abrasion and ozone resistant.

Application: air and water delivery.

Constant operation: -10 °C +60 °C (+14 °F +140 °F)

↔		↔		↕		↕		↗		⚠		⚖	
mm	in	mm	in	bar	psi	bar	psi	mm	in	%	kg/m	lb/ft	
13,0	1/2"	19,00	0,75	10	150	30	450	104,0	4,09		0,205	0,14	
16,0	5/8"	22,00	0,87	10	150	30	450	128,0	5,04		0,245	0,17	
19,0	3/4"	26,00	1,02	10	150	30	450	152,0	5,98		0,345	0,24	
25,0	1"	33,00	1,30	10	150	30	450	200,0	7,87		0,510	0,35	
32,0	1 1/4"	44,00	1,73	7	100	21	300	256,0	10,08		0,950	0,64	

// 284AH



Water delivery 10 bar (150 psi)

Tube: black synthetic elastomer - oil mist resistant.

Reinforcement: high tensile textile cords.

Cover: red synthetic elastomer - abrasion and ozone resistant.

Application: air and water delivery.

Constant operation: -10 °C +60 °C (+14 °F +140 °F)

↔		↔		↕		↕		↗		⚠		⚖	
mm	in	mm	in	bar	psi	bar	psi	mm	in	%	kg/m	lb/ft	
13,0	1/2"	19,00	0,75	10	150	30	450	104,0	4,09		0,205	0,14	
19,0	3/4"	26,00	1,02	10	150	30	450	152,0	5,98		0,345	0,24	
25,0	1"	33,00	1,30	10	150	30	450	200,0	7,87		0,510	0,35	

// 286EE



Water discharge - PVC - Lay flat - Standard duty

Tube: blue PVC.
Reinforcement: high tensile textile cords.
Cover: blue PVC - abrasion and ozone resistant.
Application: lay flat water discharge.
Constant operation: -10 °C +60 °C (+14 °F +140 °F)

↔		↔		↕		↕		↷		⚖		
mm	in	mm	in	bar	psi	bar	psi	mm	in	%	kg/m	lb/ft
38,0	1 1/2"			5	75	15	225				0,210	0,15
51,0	2"			5	75	15	225				0,270	0,19
63,0	2 1/2"			4	60	12	180				0,380	0,26
76,0	3"			4	60	12	180				0,530	0,36
102,0	4"			4	60	12	180				0,710	0,48
152,0	6"			3	45	9	135				1,180	0,80
203,0	8"			3	45	9	135				1,800	1,21

// 288HH



Water discharge - PVC - Lay flat - Heavy duty

Tube: Red PVC.
Reinforcement: high tensile textile cords.
Cover: red PVC - abrasion and ozone resistant.
Application: lay flat water discharge.
Constant operation: -10 °C +60 °C (+14 °F +140 °F)

↔		↔		↕		↕		↷		⚖		
mm	in	mm	in	bar	psi	bar	psi	mm	in	%	kg/m	lb/ft
25,0	1"			10	150	30	450				0,250	0,17
32,0	1 1/4"			10	150	30	450				0,300	0,21
38,0	1 1/2"			10	150	30	450				0,330	0,23
45,0	1 3/4"			10	150	30	450				0,430	0,29
51,0	2"			8	120	24	350				0,480	0,33
63,0	2 1/2"			8	120	24	350				0,590	0,40
76,0	3"			7	100	21	300				0,770	0,52
102,0	4"			6	90	18	270				0,980	0,66
152,0	6"			5	75	15	225				1,600	1,08

Dimensions shown may be changed without prior notice

// 250AA



Water discharge 5 bar (75 psi) - Lay flat

Tube: black EPDM.
Reinforcement: high tensile textile cords.
Cover: black EPDM - abrasion and ozone resistant.
Application: lay flat water discharge.
Constant operation: -30 °C +80 °C (-22 °F +176 °F)

↔		↔		↻		↻		⤴		⚖		
mm	in	mm	in	bar	psi	bar	psi	mm	in	%	kg/m	lb/ft
102,0	4"	110,00	4,33	5	75	15	225				1,670	1,13
152,0	6"	160,00	6,30	5	75	10	150				2,430	1,64
203,0	8"	213,00	8,39	5	75	10	150				3,260	2,20
254,0	10"	264,00	10,39	5	75	10	150				4,010	2,70

// 253AA



Water discharge 10 bar (150 psi) - Lay flat

Tube: black EPDM.
Reinforcement: high tensile textile cords.
Cover: black EPDM - abrasion and ozone resistant.
Application: lay flat water discharge.
Constant operation: -30 °C +80 °C (-22 °F +176 °F)

↔		↔		↻		↻		⤴		⚖		
mm	in	mm	in	bar	psi	bar	psi	mm	in	%	kg/m	lb/ft
32,0	1 1/4"	40,00	1,57	10	150	30	450				0,460	0,31
38,0	1 1/2"	46,00	1,81	10	150	30	450				0,540	0,37
40,0	1 9/16"	48,00	1,89	10	150	30	450				0,570	0,39
45,0	1 3/4"	53,00	2,09	10	150	30	450				0,660	0,45
51,0	2"	59,00	2,32	10	150	30	450				0,730	0,50
60,0	2 3/8"	68,00	2,68	10	150	30	450				0,860	0,58
63,0	2 1/2"	71,00	2,80	10	150	30	450				0,900	0,61
70,0	2 3/4"	80,00	3,15	10	150	30	450				1,380	0,93
76,0	3"	86,00	3,39	10	150	30	450				1,480	1,00
90,0	3 1/2"	100,00	3,94	10	150	30	450				1,720	1,16
102,0	4"	112,00	4,41	10	150	30	450				2,040	1,38
127,0	5"	139,00	5,47	10	150	30	450				2,730	1,84
152,0	6"	164,00	6,46	10	150	30	450				3,360	2,26
168,0	6 5/8"	180,00	7,09	10	150	30	450				3,560	2,40
203,0	8"	217,00	8,54	10	150	20	300				4,810	3,24
254,0	10"	270,00	10,63	10	150	20	300				7,680	5,17
305,0	12"	319,00	12,56	10	150	20	300				8,870	5,97

// 254AA



Air-water delivery 10 bar (150 psi)

Tube: black SBR.
Reinforcement: high tensile textile cords.
Cover: black SBR - abrasion and ozone resistant.
Application: air and water delivery.
Constant operation: -30 °C +80 °C (-22 °F +176 °F)

↔		↔		↕		↕		↷		⚖		
mm	in	mm	in	bar	psi	bar	psi	mm	in	%	kg/m	lb/ft
19,0	3/4"	27,00	1,06	10	150	30	450				0,400	0,27
25,0	1"	33,00	1,30	10	150	30	450				0,540	0,37
32,0	1 1/4"	42,00	1,65	10	150	30	450				0,830	0,56
38,0	1 1/2"	48,00	1,89	10	150	30	450				0,980	0,66
51,0	2"	61,00	2,40	10	150	30	450				1,290	0,87
63,0	2 1/2"	75,00	2,95	10	150	30	450				1,920	1,30
76,0	3"	88,00	3,46	10	150	30	450				2,310	1,56
102,0	4"	114,00	4,49	10	150	30	450				3,120	2,10
152,0	6"	166,00	6,54	10	150	30	450				4,690	3,16
203,0	8"	219,00	8,62	10	150	20	300				6,950	4,68

// 254AH



Air-water delivery 10 bar (150 psi)

Tube: black SBR.
Reinforcement: high tensile textile cords.
Cover: red SBR - abrasion and ozone resistant.
Application: air and water delivery.
Constant operation: -30 °C +80 °C (-22 °F +176 °F)

↔		↔		↕		↕		↷		⚖		
mm	in	mm	in	bar	psi	bar	psi	mm	in	%	kg/m	lb/ft
32,0	1 1/4"	42,00	1,65	10	150	30	450				0,830	0,56
38,0	1 1/2"	48,00	1,89	10	150	30	450				0,970	0,66
51,0	2"	61,00	2,40	10	150	30	450				1,290	0,87

// 256AA



Water-irrigation 18 bar (270 psi) - Heavy duty

Tube: black EPDM.
Reinforcement: high tensile textile cords.
Cover: black EPDM - abrasion and ozone resistant.
Application: heavy duty water discharge. Specially designed for high pressure irrigation systems.
Constant operation: -30 °C +80 °C (-22 °F +176 °F)

↔		↔		↕		↕		↷		⚖		
mm	in	mm	in	bar	psi	bar	psi	mm	in	%	kg/m	lb/ft
51,0	2"	61,00	2,40	18	270	45	650				1,070	0,72
60,0	2 3/8"	72,00	2,83	18	270	45	650				1,390	0,94
70,0	2 3/4"	82,00	3,23	18	270	45	650				1,610	1,09
76,0	3"	88,00	3,46	18	270	45	650				1,720	1,16
80,0	3 1/8"	92,00	3,62	18	270	45	650				1,880	1,27
90,0	3 1/2"	102,00	4,02	18	270	45	650				2,080	1,40
102,0	4"	114,00	4,49	18	270	45	650				2,360	1,59
120,0	4 3/4"	132,00	5,20	18	270	45	650				2,870	1,93
152,0	6"	168,00	6,61	18	270	36	540				4,920	3,31

Dimensions shown may be changed without prior notice

// 264GL



Water S&D - PVC - Light duty

Construction: green transparent PVC - abrasion and ozone resistant.

Reinforcement: white shock resistant rigid PVC.

Application: water suction and delivery.

Constant operation: -5 °C +60 °C (+23 °F +140 °F)

↔		↔		↻		↻		⤴		⌘		Ⓜ	
mm	in	mm	in	bar	psi	bar	psi	mm	in	%	kg/m	lb/ft	
20,0	13/16"			7	100	21	300	110,0	4,33	60	0,200	0,14	
25,0	1"			7	100	21	300	138,0	5,43	60	0,250	0,17	
32,0	1 1/4"			6	90	18	270	176,0	6,93	60	0,340	0,23	
38,0	1 1/2"			5	75	15	225	209,0	8,23	60	0,440	0,30	
51,0	2"			5	75	15	225	281,0	11,06	60	0,650	0,44	

// 266GL



Water S&D - PVC - Standard duty

Construction: green transparent PVC - abrasion and ozone resistant.

Reinforcement: white shock resistant rigid PVC.

Application: water suction and delivery.

Constant operation: -5 °C +60 °C (+23 °F +140 °F)

↔		↔		↻		↻		⤴		⌘		Ⓜ	
mm	in	mm	in	bar	psi	bar	psi	mm	in	%	kg/m	lb/ft	
25,0	1"			7	100	21	300	113,0	4,45	70	0,290	0,20	
32,0	1 1/4"			6	90	18	270	144,0	5,67	70	0,390	0,27	
38,0	1 1/2"			5	75	15	225	171,0	6,73	70	0,510	0,35	
45,0	1 3/4"			5	75	15	225	203,0	7,99	70	0,670	0,46	
51,0	2"			5	75	15	225	230,0	9,06	70	0,760	0,52	
63,0	2 1/2"			5	75	15	225	284,0	11,18	70	0,970	0,66	
76,0	3"			5	75	15	225	342,0	13,46	70	1,330	0,90	
90,0	3 1/2"			4	60	12	180	405,0	15,94	70	1,800	1,21	
102,0	4"			4	60	12	180	459,0	18,07	70	2,190	1,48	
127,0	5"			3	45	9	135	597,0	23,50	50	2,900	1,95	
152,0	6"			3	45	9	135	714,0	28,11	50	4,000	2,69	
203,0	8"			2	30	6	90	954,0	37,56	40	6,200	4,17	

// 266KL



Water S&D - PVC - Standard duty

Construction: Yellow transparent PVC - abrasion and ozone resistant.

Reinforcement: white shock resistant rigid PVC.

Application: water suction and delivery.

Constant operation: -5 °C +60 °C (+23 °F +140 °F)

↔		↔		↻		↻		⤴		⤵		⚖	
mm	in	mm	in	bar	psi	bar	psi	mm	in	%	kg/m	lb/ft	
20,0	13/16"			7	100	21	300	90,0	3,54	70	0,230	0,16	
25,0	1"			7	100	21	300	113,0	4,45	70	0,290	0,20	
30,0	1 3/16"			6	90	18	270	135,0	5,31	70	0,360	0,25	
32,0	1 1/4"			6	90	18	270	144,0	5,67	70	0,390	0,27	
35,0	1 3/8"			6	90	18	270	158,0	6,22	70	0,440	0,30	
38,0	1 1/2"			5	75	15	225	171,0	6,73	70	0,510	0,35	
40,0	1 9/16"			5	75	15	225	180,0	7,09	70	0,540	0,37	
45,0	1 3/4"			5	75	15	225	203,0	7,99	70	0,670	0,46	
51,0	2"			5	75	15	225	230,0	9,06	70	0,760	0,52	
60,0	2 3/8"			5	75	15	225	270,0	10,63	70	0,920	0,62	
63,0	2 1/2"			5	75	15	225	284,0	11,18	70	0,970	0,66	
76,0	3"			5	75	15	225	342,0	13,46	70	1,330	0,90	
80,0	3 1/8"			4	60	12	180	360,0	14,17	70	1,450	0,98	
102,0	4"			4	60	12	180	459,0	18,07	70	2,190	1,48	

// 2660L



Water S&D - PVC - Standard duty - Super elastic

Construction: transparent PVC - abrasion and ozone resistant.

Reinforcement: white shock resistant rigid PVC.

Application: water suction and delivery. Good flexibility at low temperature.

Constant operation: -20 °C +60 °C (-4 °F +140 °F)

↔		↔		↻		↻		⤴		⤵		⚖	
mm	in	mm	in	bar	psi	bar	psi	mm	in	%	kg/m	lb/ft	
38,0	1 1/2"			5	75	15	225	152,0	5,98	60	0,510	0,35	
45,0	1 3/4"			5	75	15	225	180,0	7,09	60	0,670	0,46	
51,0	2"			5	75	15	225	204,0	8,03	60	0,760	0,52	

Dimensions shown may be changed without prior notice

// 265TH



Water-slurry S&D - PVC - Standard duty - Super elastic

Construction: Light blue PVC with helical red stripe - abrasion and ozone resistant.

Reinforcement: white shock resistant rigid PVC.

Application: water suction and delivery. Special light weight construction for slurry tankers. Good flexibility at low temperature.

Constant operation: -20 °C +60 °C (-4 °F +140 °F)

↔		↔		↻		↻		⤴		⚖		
mm	in	mm	in	bar	psi	bar	psi	mm	in	%	kg/m	lb/ft
51,0	2"			5	75	15	225	204,0	8,03	90	0,860	0,58
63,0	2 1/2"			4	60	12	180	252,0	9,92	90	1,265	0,86
76,0	3"			4	60	12	180	304,0	11,97	90	1,515	1,02
102,0	4"			3	45	9	135	408,0	16,06	90	2,220	1,50
127,0	5"			3	45	9	135	508,0	20,00	90	3,230	2,18
152,0	6"			2	30	6	90	608,0	23,94	90	4,140	2,79

// 267BE



Water-slurry S&D - PVC - Medium duty - Super elastic

Construction: grey PVC with helical blue stripe - abrasion and ozone resistant.

Reinforcement: white shock resistant rigid PVC.

Application: water suction and delivery. Special construction for slurry tankers. Good flexibility at low temperature.

Constant operation: -20 °C +60 °C (-4 °F +140 °F)

↔		↔		↻		↻		⤴		⚖		
mm	in	mm	in	bar	psi	bar	psi	mm	in	%	kg/m	lb/ft
25,0	1"			7	100	21	300	100,0	3,94	90	0,415	0,28
32,0	1 1/4"			7	100	21	300	128,0	5,04	90	0,605	0,41
38,0	1 1/2"			7	100	21	300	152,0	5,98	90	0,705	0,48
51,0	2"			5	75	15	225	204,0	8,03	90	1,000	0,68
60,0	2 3/8"			5	75	15	225	240,0	9,45	90	1,280	0,87
63,0	2 1/2"			5	75	15	225	252,0	9,92	90	1,340	0,91
76,0	3"			5	75	15	225	304,0	11,97	90	1,750	1,18
80,0	3 1/8"			5	75	15	225	320,0	12,60	90	1,840	1,24
90,0	3 1/2"			4	60	12	180	360,0	14,17	90	2,260	1,52
102,0	4"			4	60	12	180	408,0	16,06	90	2,700	1,82
110,0	4 5/16"			4	60	12	180	440,0	17,32	90	3,100	2,09
120,0	4 3/4"			4	60	12	180	480,0	18,90	90	3,600	2,42
127,0	5"			4	60	12	180	508,0	20,00	90	3,800	2,56
152,0	6"			3	45	9	135	608,0	23,94	90	4,850	3,26
203,0	8"			3	45	9	135	812,0	31,97	90	9,100	6,12

// 269BA



Water-slurry S&D - PVC/NBR - Medium duty - Superior flexibility



Construction: grey PVC/NBR - abrasion and ozone resistant.

Reinforcement: black shock resistant rigid PVC.

Application: water suction and delivery. Special construction for slurry tankers and general applications. Superior flexibility at low temperature.

Constant operation: -30 °C +60 °C (-22 °F +140 °F)

↔		↔		↻		↻		⤴		⚖		
mm	in	mm	in	bar	psi	bar	psi	mm	in	%	kg/m	lb/ft
51,0	2"			5	75	15	225	178,0	7,01	90	1,010	0,68
63,0	2 1/2"			5	75	15	225	220,0	8,66	90	1,365	0,92
76,0	3"			5	75	15	225	266,0	10,47	90	1,765	1,19
90,0	3 1/2"			4	60	12	180	315,0	12,40	90	2,265	1,53
102,0	4"			4	60	12	180	357,0	14,06	90	2,720	1,83
127,0	5"			3	45	9	135	444,0	17,48	90	3,830	2,58
152,0	6"			3	45	9	135	532,0	20,94	90	4,935	3,32

// 268BL



Water-abrasive slurry S&D - PVC - Heavy duty

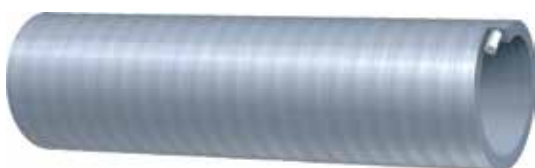

Construction: grey PVC - abrasion and ozone resistant.

Reinforcement: white shock resistant rigid PVC.

Application: heavy duty water suction and delivery. Also suitable for abrasive slurries transfer.

Constant operation: -5 °C +60 °C (+23 °F +140 °F)

↔		↔		↻		↻		⤴		⚖		
mm	in	mm	in	bar	psi	bar	psi	mm	in	%	kg/m	lb/ft
25,0	1"			7	100	21	300	150,0	5,91	90	0,520	0,35
32,0	1 1/4"			6	90	18	270	192,0	7,56	90	0,650	0,44
38,0	1 1/2"			6	90	18	270	228,0	8,98	90	0,760	0,52
51,0	2"			5	75	15	225	306,0	12,05	90	1,100	0,74
63,0	2 1/2"			4	60	12	180	378,0	14,88	90	1,550	1,05
76,0	3"			4	60	12	180	456,0	17,95	90	1,900	1,28
80,0	3 1/8"			4	60	12	180	480,0	18,90	90	2,100	1,42
90,0	3 1/2"			4	60	12	180	540,0	21,26	90	2,500	1,69
102,0	4"			3	45	9	135	612,0	24,09	90	3,200	2,16
127,0	5"			3	45	9	135	762,0	30,00	90	4,200	2,83
152,0	6"			2	30	6	90	912,0	35,91	90	6,000	4,04
203,0	8"			2	30	6	90	1218,0	47,95	60	10,000	6,73

Dimensions shown may be changed without prior notice

// 47200



General purpose food quality S&D - PVC
FDA - EU 10/2011 A+B+C - AS 2070

Construction: transparent PVC - abrasion and ozone resistant.

Reinforcement: Steel helix wire.

Application: general purpose liquid food and alcoholic beverages suction and delivery - max 20% - Sterilize with 5% soda solution.

Constant operation: -5 °C +60 °C (+23 °F +140 °F)

↔		↔		↻		↻		⤴		⤵		
mm	in	mm	in	bar	psi	bar	psi	mm	in	%	kg/m	lb/ft
10,0	3/8"	16,00	0,63	15	225	45	650	40,0	1,57	90	0,160	0,11
13,0	1/2"	19,00	0,75	7	100	21	300	52,0	2,05	85	0,195	0,14
14,0	9/16"	20,00	0,79	6	90	18	270	56,0	2,20	85	0,210	0,15
16,0	5/8"	22,00	0,87	6	90	18	270	64,0	2,52	85	0,250	0,17
18,0	23/32"	25,00	0,98	6	90	18	270	72,0	2,83	85	0,300	0,21
20,0	13/16"	27,00	1,06	5	75	15	225	80,0	3,15	85	0,330	0,23
22,0	7/8"	29,00	1,14	5	75	15	225	88,0	3,46	85	0,380	0,26
25,0	1"	33,00	1,30	5	75	15	225	100,0	3,94	85	0,515	0,35
30,0	1 3/16"	38,00	1,50	4	60	12	180	120,0	4,72	85	0,610	0,41
32,0	1 1/4"	40,00	1,57	4	60	12	180	128,0	5,04	85	0,650	0,44
35,0	1 3/8"	44,00	1,73	4	60	12	180	140,0	5,51	85	0,785	0,53
38,0	1 1/2"	47,00	1,85	4	60	12	180	152,0	5,98	85	0,810	0,55
40,0	1 9/16"	49,00	1,93	3	45	9	135	160,0	6,30	85	0,885	0,60
45,0	1 3/4"	55,00	2,17	3	45	9	135	180,0	7,09	80	1,100	0,74
51,0	2"	61,00	2,40	3	45	9	135	204,0	8,03	80	1,230	0,83
60,0	2 3/8"	72,00	2,83	2	30	6	90	240,0	9,45	80	1,700	1,15
63,0	2 1/2"	75,00	2,95	2	30	6	90	252,0	9,92	80	1,775	1,20
70,0	2 3/4"	84,00	3,31	2	30	6	90	280,0	11,02	80	2,030	1,37
76,0	3"	90,00	3,54	2	30	6	90	304,0	11,97	70	2,350	1,58
80,0	3 1/8"	94,00	3,70	2	30	6	90	320,0	12,60	70	2,500	1,69
90,0	3 1/2"	104,00	4,09	2	30	6	90	360,0	14,17	70	3,000	2,02
102,0	4"	116,00	4,57	2	30	6	90	408,0	16,06	70	3,480	2,34
105,0	4 1/8"	121,00	4,76	3	45	9	135	420,0	16,54	90	4,250	2,86
152,0	6"	172,00	6,77	2	30	6	90	608,0	23,94	70	7,200	4,84

// 204AA



Water S&D 5 bar (75 psi)

Tube: black SBR.

Reinforcement: high tensile textile cords with embedded steel helix wire.

Cover: black SBR - abrasion and ozone resistant.

Application: water suction and delivery.

Constant operation: -30 °C +80 °C (-22 °F +176 °F)

↔		↔		↻		↻		⤴		⚖		
mm	in	mm	in	bar	psi	bar	psi	mm	in	%	kg/m	lb/ft
152,0	6"	166,00	6,54	5	75	15	225	760,0	29,92	80	6,180	4,16
203,0	8"	221,00	8,70	5	75	15	225	1015,0	39,96	70	10,580	7,12

// 202AA



General purpose S&D 10 bar (150 psi) - EPDM

Tube: black conductive EPDM.

Reinforcement: high tensile textile cords with embedded steel helix wire.

Cover: black conductive EPDM - abrasion and ozone resistant.

Application: water suction and delivery. Also suitable for mild chemicals and fertilizers in general industrial and agricultural applications.

Constant operation: -40 °C +100 °C (-40 °F +212 °F) depending on conveyed chemical

↔		↔		↻		↻		⤴		⚖		
mm	in	mm	in	bar	psi	bar	psi	mm	in	%	kg/m	lb/ft
25,0	1"	36,00	1,42	10	150	30	450	100,0	3,94	100	0,730	0,50
30,0	1 3/16"	41,00	1,61	10	150	30	450	120,0	4,72	100	0,820	0,56
32,0	1 1/4"	43,00	1,69	10	150	30	450	128,0	5,04	100	0,860	0,58
38,0	1 1/2"	49,00	1,93	10	150	30	450	152,0	5,98	100	1,000	0,68
40,0	1 9/16"	51,00	2,01	10	150	30	450	160,0	6,30	100	1,050	0,71
45,0	1 3/4"	56,00	2,20	10	150	30	450	180,0	7,09	100	1,170	0,79
51,0	2"	62,00	2,44	10	150	30	450	204,0	8,03	100	1,300	0,88
60,0	2 3/8"	73,00	2,87	10	150	30	450	240,0	9,45	100	2,000	1,35
63,0	2 1/2"	76,00	2,99	10	150	30	450	252,0	9,92	90	2,090	1,41
70,0	2 3/4"	83,00	3,27	10	150	30	450	280,0	11,02	90	2,330	1,57
76,0	3"	89,00	3,50	10	150	30	450	304,0	11,97	90	2,500	1,69
80,0	3 1/8"	93,00	3,66	10	150	30	450	320,0	12,60	90	2,680	1,81
90,0	3 1/2"	104,00	4,09	10	150	30	450	360,0	14,17	90	3,120	2,10
102,0	4"	116,00	4,57	10	150	30	450	408,0	16,06	90	3,480	2,34
110,0	4 5/16"	124,00	4,88	10	150	30	450	440,0	17,32	80	3,710	2,50
115,0	4 1/2"	129,00	5,08	10	150	30	450	460,0	18,11	80	3,860	2,60
120,0	4 3/4"	136,00	5,35	10	150	30	450	600,0	23,62	80	5,070	3,41
127,0	5"	143,00	5,63	10	150	30	450	635,0	25,00	80	5,330	3,59
152,0	6"	168,00	6,61	10	150	25	375	760,0	29,92	80	6,660	4,48
203,0	8"	221,00	8,70	10	150	25	375	812,0	31,97	70	9,880	6,64
254,0	10"	272,00	10,71	10	150	25	375	1270,0	50,00	60	13,520	9,09

Dimensions shown may be changed without prior notice

// 223AA



Water S&D 20 bar (300 psi) - Heavy duty

Tube: black conductive EPDM.

Reinforcement: high tensile textile cords with embedded steel helix wire.

Cover: black conductive EPDM - abrasion and ozone resistant.

Application: water suction and delivery. Designed for long service life in heavy duty applications.

Constant operation: -30 °C +100 °C (-22 °F +212 °F)

↔		↔		↻		↻		⤴		⤵		⚖	
mm	in	mm	in	bar	psi	bar	psi	mm	in	%	kg/m	lb/ft	
51,0	2"	63,00	2,48	20	300	60	900	204,0	8,03	100	1,450	0,98	
63,0	2 1/2"	77,00	3,03	20	300	60	900	252,0	9,92	90	2,070	1,40	
76,0	3"	90,00	3,54	20	300	60	900	304,0	11,97	90	2,540	1,71	
102,0	4"	116,00	4,57	20	300	60	900	408,0	16,06	90	3,490	2,35	
152,0	6"	168,00	6,61	20	300	60	900	608,0	23,94	80	6,800	4,57	
203,0	8"	225,00	8,86	20	300	60	900	812,0	31,97	70	10,920	7,34	

// 221AA



Water-slurry S&D - Corrugated - Soft ends

Tube: black SBR.

Reinforcement: high tensile textile cords with embedded steel helix wire.

Cover: black SBR - abrasion and ozone resistant.

Application: water suction and delivery. Special light weight and flexible construction for slurry tankers.

Constant operation: -30 °C +80 °C (-22 °F +176 °F)

↔		↔		↻		↻		⤴		⤵		⚖	
mm	in	mm	in	bar	psi	bar	psi	mm	in	%	kg/m	lb/ft	
76,0	3"			5	75	15	225	152,0	5,98	90	2,230	1,50	
102,0	4"			5	75	15	225	204,0	8,03	90	2,940	1,98	
120,0	4 3/4"			5	75	15	225	240,0	9,45	90	3,710	2,50	
152,0	6"			3	45	9	135	304,0	11,97	80	4,650	3,13	
203,0	8"			3	45	9	135	406,0	15,98	70	6,370	4,29	

// 222AA



Heavy duty dewatering - EPDM - Corrugated - Soft ends

Tube: black EPDM.

Reinforcement: high tensile textile cords with embedded steel helix wire.

Cover: black EPDM - abrasion and ozone resistant.

Application: heavy duty suction. Specially designed for full vacuum dewatering applications. Also suitable for mild chemicals.

Constant operation: -50 °C +80 °C (-58 °F +176 °F)

↔		↔		↻		↻		⤴		⚖		
mm	in	mm	in	bar	psi	bar	psi	mm	in	%	kg/m	lb/ft
152,0	6"			10	150	30	450	608,0	23,94	100	6,680	4,49
203,0	8"			10	150	30	450	812,0	31,97	100	8,900	5,99
254,0	10"			10	150	30	450	1016,0	40,00	100	12,600	8,47
300,0	12"			10	150	30	450	1200,0	47,24	100	19,010	12,78

// 268LL



Pools-spa water circulation

Construction: white PVC - abrasion and ozone resistant.

Reinforcement: white shock resistant rigid PVC.

Application: water circulation systems for pools and SPA. Hose outside diameters made to fit rigid PVC pipe fittings.

Constant operation: -5 °C +60 °C (+23 °F +140 °F)

↔		↔		↻		↻		⤴		⚖		
mm	in	mm	in	bar	psi	bar	psi	mm	in	%	kg/m	lb/ft
28,0	1 1/8"	32,00	1,26	6	90	18	270	168,0	6,61	90	0,250	0,17
32,0	1 1/4"	40,00	1,57	6	90	18	270	192,0	7,56	90	0,540	0,37
42,0	1 5/8"	50,00	1,97	6	90	18	270	252,0	9,92	90	0,780	0,53
55,0	2 1/6"	63,00	2,48	5	75	15	225	330,0	12,99	90	0,840	0,57

Dimensions shown may be changed without prior notice

// 248AE

**High pressure water delivery 100 bar (1500 psi)
- Snow maker - Steel braided**

Tube: black SBR.

Reinforcement: high tensile steel wire braid.

Cover: blue CSM - abrasion and ozone resistant.

Application: high pressure water delivery. Specially designed for artificial snow makers. Designed for use of EN 853 1SN fittings.

Constant operation: -30 °C +80 °C (-22 °F +176 °F)

↔		↔		↻		↻		⤴		⚖	⚖	
mm	in	mm	in	bar	psi	bar	psi	mm	in	%	kg/m	lb/ft
25,0	1"	36,00	1,42	100	1500	200	2900				0,980	0,66
38,0	1 1/2"	50,00	1,97	100	1500	200	2900				1,570	1,06



// AGRICULTURE



591AE	Crop spraying 40 bar (600 psi) - PVC.....	51
593AK	Crop spraying 80 bar (1200 psi) - PVC.....	51
266OA	Air seeder - PVC.....	52
702AA	Air seeder.....	52

Dimensions shown may be changed without prior notice

// 591AE



Crop spraying 40 bar (600 psi) - PVC

Tube: black PVC.

Reinforcement: high tensile textile cords.

Cover: blue PVC - abrasion and ozone resistant.

Application: crop spraying of fertilizers, pesticides and weed-killers.

Constant operation: -5 °C +60 °C (+23 °F +140 °F)

↔		↔		↙		↘		⤴		⚖		
mm	in	mm	in	bar	psi	bar	psi	mm	in	%	kg/m	lb/ft
8,0	5/16"	14,00	0,55	50	730	125	1820	64,0	2,52		0,135	0,10
10,0	3/8"	16,00	0,63	50	730	125	1820	80,0	3,15		0,160	0,11
13,0	1/2"	20,00	0,79	40	600	120	1750	104,0	4,09		0,225	0,16
16,0	5/8"	24,00	0,94	40	600	120	1750	128,0	5,04		0,320	0,22
19,0	3/4"	27,00	1,06	40	600	120	1750	152,0	5,98		0,370	0,25
25,0	1"	34,00	1,34	40	600	100	1500	200,0	7,87		0,525	0,36

// 593AK



Crop spraying 80 bar (1200 psi) - PVC

Tube: black PVC.

Reinforcement: high tensile textile cords.

Cover: yellow ribbed PVC with longitudinal black stripe - abrasion and ozone resistant.

Application: crop spraying of fertilizers, pesticides and weed-killers.

Constant operation: -5 °C +60 °C (+23 °F +140 °F)

↔		↔		↙		↘		⤴		⚖		
mm	in	mm	in	bar	psi	bar	psi	mm	in	%	kg/m	lb/ft
8,0	5/16"	15,00	0,59	80	1200	200	2900	64,0	2,52		0,160	0,11
10,0	3/8"	18,00	0,71	80	1200	200	2900	80,0	3,15		0,230	0,16
13,0	1/2"	22,00	0,87	80	1200	200	2900	104,0	4,09		0,320	0,22

// 2660A



Air seeder - PVC

Construction: transparent PVC - abrasion and ozone resistant.
Reinforcement: black shock resistant rigid PVC.
Application: agricultural seed transfer in "Air-Flo" seeding equipments.
Constant operation: -5 °C +60 °C (+23 °F +140 °F)

↔		↔		↕		↕		⤴		⚖		
mm	in	mm	in	bar	psi	bar	psi	mm	in	%	kg/m	lb/ft
25,0	1"			8	120	24	350	113,0	4,45	70	0,295	0,20
32,0	1 1/4"			7	100	21	300	144,0	5,67	70	0,395	0,27
38,0	1 1/2"			6	90	18	270	171,0	6,73	70	0,515	0,35
45,0	1 3/4"			6	90	18	270	203,0	7,99	70	0,675	0,46
51,0	2"			5	75	15	225	230,0	9,06	70	0,765	0,52
63,0	2 1/2"			5	75	15	225	284,0	11,18	70	1,190	0,80
76,0	3"			5	75	15	225	342,0	13,46	70	1,520	1,03

// 702AA



Air seeder

Tube: black conductive NR.
Reinforcement: high tensile textile cords with embedded steel helix wire.
Cover: black NBR/PVC - oil, heat, abrasion and ozone resistant.
Application: agricultural seed transfer in "Air-Flo" seeding equipments.
Constant operation: -30 °C +80 °C (-22 °F +176 °F)

↔		↔		↕		↕		⤴		⚖		
mm	in	mm	in	bar	psi	bar	psi	mm	in	%	kg/m	lb/ft
32,0	1 1/4"	43,00	1,69	10	150	30	450	128,0	5,04	100	0,880	0,60
38,0	1 1/2"	49,00	1,93	10	150	30	450	152,0	5,98	100	1,000	0,68
45,0	1 3/4"	56,00	2,20	10	150	30	450	180,0	7,09	100	1,190	0,80
51,0	2"	62,00	2,44	10	150	30	450	204,0	8,03	100	1,330	0,90
63,0	2 1/2"	76,00	2,99	10	150	30	450	252,0	9,92	90	2,020	1,36
76,0	3"	89,00	3,50	10	150	30	450	304,0	11,97	90	2,410	1,62



// FIRE FIGHTING



283AA	Fire reel 12 bar (180 psi) - EN 694/A2.....	54
251AA	Fire reel 40 bar (600 psi) - Textile braided - NF EN 1947/C/1/II.....	54
212AA	Fire engine water S&D 5 bar (75 psi) - NF EN ISO 14557/A.....	54

// 283AA



**Fire reel 12 bar (180 psi)
EN 694/A2**

Tube: black synthetic elastomer.
Reinforcement: high tensile textile cords.
Cover: black synthetic elastomer - abrasion and ozone resistant.
Application: fire reels.
Constant operation: -20 °C +60 °C (-4 °F +140 °F)

↔		↔		↻		↻		⤴		⚠	⚖	
mm	in	mm	in	bar	psi	bar	psi	mm	in	%	kg/m	lb/ft
25,0	1"	34,00	1,34	12	180	48	720	200,0	7,87		0,570	0,39

// 251AA



**Fire reel 40 bar (600 psi) - Textile braided
NF EN 1947/C/1/II**

Tube: black SBR.
Reinforcement: high tensile textile braids.
Cover: black SBR - abrasion and ozone resistant.
Application: hose reels on fire fighting vehicles.
Constant operation: -30 °C +80 °C (-22 °F +176 °F)

↔		↔		↻		↻		⤴		⚠	⚖	
mm	in	mm	in	bar	psi	bar	psi	mm	in	%	kg/m	lb/ft
25,0	1"	36,00	1,42	40	600	120	1750	100,0	3,94		0,620	0,42

// 212AA



**Fire engine water S&D 5 bar (75 psi)
NF EN ISO 14557/A**

Tube: black SBR.
Reinforcement: high tensile textile cords with embedded steel helix wire.
Cover: black SBR - abrasion and ozone resistant.
Application: water suction and delivery on fire fighting vehicles.
Constant operation: -30 °C +80 °C (-22 °F +176 °F)

↔		↔		↻		↻		⤴		⚠	⚖	
mm	in	mm	in	bar	psi	bar	psi	mm	in	%	kg/m	lb/ft
45,0	1 3/4"	55,00	2,17	5	75	15	225	180,0	7,09	100	1,510	1,02
70,0	2 3/4"	82,00	3,23	5	75	15	225	280,0	11,02	90	2,760	1,86
110,0	4 5/16"	122,00	4,80	5	75	15	225	440,0	17,32	80	4,710	3,17



// FURNACE & CABLE COOLING



254AL	Furnace cooling 10 bar (150 psi) - Soft wall.....	56
203AL	Furnace cooling 10 bar (150 psi) - Hard wall.....	56
957LL	Cable cooling 20 bar (300 psi) - Non conductive.....	57

// 254AL



Furnace cooling 10 bar (150 psi) - Soft wall

Tube: black SBR.
Reinforcement: high tensile textile cords.
Cover: black SBR - resin coated dust free fibreglass cover.
Application: general purpose water delivery in furnace cooling applications. Specially designed to withstand heat, splashes of molten metal and open flame.
Constant operation: -30 °C +80 °C (-22 °F +176 °F) cover resistant up to 540 °C (1000 °F)

↔		↔		↻		↻		⤴		⚖		
mm	in	mm	in	bar	psi	bar	psi	mm	in	%	kg/m	lb/ft
19,0	3/4"	31,00	1,22	10	150	30	450				0,710	0,48
25,0	1"	37,00	1,46	10	150	30	450				0,890	0,60
32,0	1 1/4"	46,00	1,81	10	150	30	450				1,290	0,87
38,0	1 1/2"	52,00	2,05	10	150	30	450				1,500	1,01
51,0	2"	65,00	2,56	10	150	30	450				1,950	1,32

// 203AL



Furnace cooling 10 bar (150 psi) - Hard wall

Tube: black SBR.
Reinforcement: high tensile textile cords with embedded steel helix wire.
Cover: black SBR - resin coated dust free fibreglass cover.
Application: general purpose water suction and delivery in furnace cooling applications. Specially designed to withstand heat, splashes of molten metal and open flame.
Constant operation: -30 °C +80 °C (-22 °F +176 °F) cover resistant up to 540 °C (1000 °F)

↔		↔		↻		↻		⤴		⚖		
mm	in	mm	in	bar	psi	bar	psi	mm	in	%	kg/m	lb/ft
51,0	2"	63,00	2,48	10	150	30	450	255,0	10,04	100	1,810	1,22
60,0	2 3/8"	72,00	2,83	10	150	30	450	300,0	11,81	100	2,260	1,52
63,0	2 1/2"	75,00	2,95	10	150	30	450	315,0	12,40	90	2,360	1,59
76,0	3"	88,00	3,46	10	150	30	450	380,0	14,96	90	2,800	1,89
80,0	3 1/8"	92,00	3,62	10	150	30	450	400,0	15,75	90	2,940	1,98
90,0	3 1/2"	102,00	4,02	10	150	30	450	450,0	17,72	90	3,780	2,55
102,0	4"	114,00	4,49	10	150	30	450	510,0	20,08	90	4,240	2,85

Dimensions shown may be changed without prior notice

// 957LL

**Cable cooling 20 bar (300 psi) - Non conductive****Tube:** white EPDM.**Reinforcement:** high tensile textile cords.**Cover:** white non conductive EPDM, heat resistant - resin coated dust free fibreglass cover.**Application:** non conductive cable cooling in electric furnaces. Specially designed to withstand heat, splashes of molten metal and open flame.**Constant operation:** -40 °C +120 °C (-40 °F +248 °F) cover resistant up to 540 °C (1000 °F)

↔		↔		↻	↻	↻	↻	↻	↻	↻	↻	↻
mm	in	mm	in	bar	psi	bar	psi	mm	in	%	kg/m	lb/ft
13,0	1/2"	25,00	0,98	20	300	60	900				0,420	0,29
19,0	3/4"	31,00	1,22	20	300	60	900				0,690	0,47
25,0	1"	37,00	1,46	20	300	60	900				0,850	0,58
32,0	1 1/4"	46,00	1,81	20	300	60	900				1,250	0,85
38,0	1 1/2"	54,00	2,13	20	300	60	900				1,440	0,97
51,0	2"	67,00	2,64	20	300	60	900				1,900	1,28
63,0	2 1/2"	81,00	3,19	20	300	60	900				2,630	1,77
76,0	3"	96,00	3,78	20	300	60	900				3,570	2,40

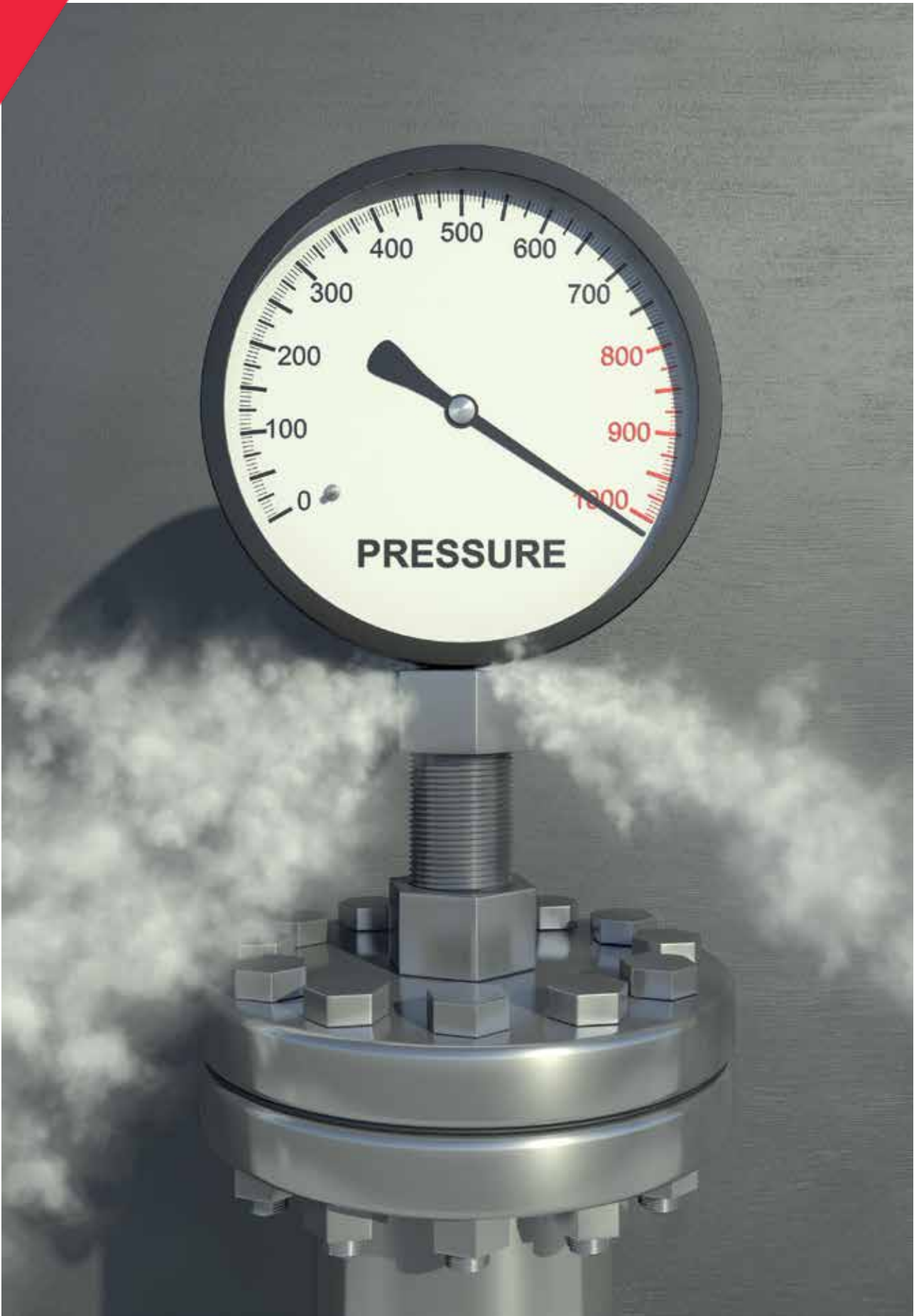



375AA	Hot water-car heater 10 bar (150 psi).....	60
352AA	Radiator 5 bar (75 psi) - exceeds DIN 73411 - SAE 20R1 D-2.....	60
395BT	Hot water wash down 50 bar (750 psi) - EU 10/2011 A+B+C.....	61
351LL	Hot water wash down 10 bar (150 psi) - Built in nozzle.....	61
351LG	Hot water wash down 10 bar (150 psi) - Built in nozzle.....	61
350LL	Steam 6 bar (90 psi) - Hot water 15 bar (225 psi) - FDA - arrêté du 09/11/94 D.....	62
350LE	Steam 6 bar (90 psi) - Hot water 15 bar (225 psi) - FDA - arrêté du 09/11/94 D.....	62
350AA	Steam 6 bar (90 psi) - Hot water 15 bar (225 psi).....	63
354AA	Steam 6 bar (90 psi) - EN ISO 6134/1A.....	63
340AA	Steam 18 bar (270 psi) - Steel braided.....	64
340AH	Steam 18 bar (270 psi) - Steel braided.....	64
344AH	Steam 18 bar (270 psi) - Steel braided - EN ISO 6134/2A.....	65
343AH	Steam 18 bar (270 psi) - Oil resistant - Steel braided - EN ISO 6134/2B.....	65
341AA	Steam 18 bar (270 psi) - CIIR - Steel braided.....	66
341AH	Steam 18 bar (270 psi) - CIIR - Steel braided.....	66
345AA	Steam 18 bar (270 psi) - CIIR - Steel braided - EN ISO 6134/2A.....	66

// 375AA



Hot water-car heater 10 bar (150 psi)

Tube: black EPDM.

Reinforcement: high tensile textile cords.

Cover: black EPDM - heat, abrasion and ozone resistant.

Application: general purpose-hot water. Specially designed for automotive heating systems.

Constant operation: -35 °C +100 °C (-31 °F +212 °F)

↔		↔		↻		↻		↵		⚖		
mm	in	mm	in	bar	psi	bar	psi	mm	in	%	kg/m	lb/ft
13,0	1/2"	19,00	0,75	10	150	30	450	130,0	5,12		0,235	0,16
16,0	5/8"	22,00	0,87	10	150	30	450	160,0	6,30		0,280	0,19
19,0	3/4"	27,00	1,06	10	150	30	450	190,0	7,48		0,445	0,30
25,0	1"	33,00	1,30	10	150	30	450	250,0	9,84		0,570	0,39

// 352AA



Radiator 5 bar (75 psi)
exceeds DIN 73411 - SAE 20R1 D-2

Tube: black EPDM.

Reinforcement: high tensile textile cords.

Cover: black EPDM - heat, abrasion and ozone resistant.

Application: radiator.

Constant operation: -40 °C +120 °C (-40 °F +248 °F)

↔		↔		↻		↻		↵		⚖		
mm	in	mm	in	bar	psi	bar	psi	mm	in	%	kg/m	lb/ft
13,0	1/2"	21,00	0,83	5	75	15	225				0,280	0,19
16,0	5/8"	24,00	0,94	5	75	15	225				0,330	0,23
18,0	23/32"	26,00	1,02	5	75	15	225				0,380	0,26
20,0	13/16"	28,00	1,10	5	75	15	225				0,390	0,27
22,0	7/8"	30,00	1,18	5	75	15	225				0,420	0,29
25,0	1"	33,00	1,30	5	75	15	225				0,470	0,32
28,0	1 1/8"	36,00	1,42	5	75	15	225				0,510	0,35
30,0	1 3/16"	38,00	1,50	5	75	15	225				0,550	0,37
32,0	1 1/4"	40,00	1,57	5	75	15	225				0,580	0,39
35,0	1 3/8"	43,00	1,69	5	75	15	225				0,620	0,42
38,0	1 1/2"	48,00	1,89	5	75	15	225				0,860	0,58
40,0	1 9/16"	50,00	1,97	5	75	15	225				0,890	0,60
42,0	1 5/8"	52,00	2,05	5	75	15	225				0,930	0,63
45,0	1 3/4"	55,00	2,17	5	75	15	225				0,990	0,67
48,0	1 7/8"	58,00	2,28	5	75	15	225				1,050	0,71
51,0	2"	61,00	2,40	5	75	15	225				1,120	0,76
55,0	2 1/6"	65,00	2,56	5	75	15	225				1,190	0,80
57,0	2 1/4"	67,00	2,64	5	75	15	225				1,230	0,83
60,0	2 3/8"	70,00	2,76	5	75	15	225				1,290	0,87
63,0	2 1/2"	73,00	2,87	5	75	15	225				1,350	0,91
70,0	2 3/4"	80,00	3,15	5	75	15	225				1,450	0,98
76,0	3"	86,00	3,39	5	75	15	225				1,560	1,05
80,0	3 1/8"	90,00	3,54	5	75	15	225				1,640	1,11
90,0	3 1/2"	102,00	4,02	5	75	15	225				2,030	1,37
102,0	4"	114,00	4,49	5	75	15	225				2,270	1,53
110,0	4 5/16"	122,00	4,80	5	75	15	225				2,430	1,64
115,0	4 1/2"	127,00	5,00	5	75	15	225				2,530	1,71
127,0	5"	141,00	5,55	5	75	15	225				3,230	2,18

Dimensions shown may be changed without prior notice

// 395BT



**Hot water wash down 50 bar (750 psi)
EU 10/2011 A+B+C**

Tube: grey non-toxic PVC.

Reinforcement: high tensile textile cords.

Cover: light blue synthetic elastomer - abrasion, ozone, animal fats and vegetable oils resistant.

Application: hot water wash down. Specially designed for the food and dairy industry. Designed for 50 bar at 70° C continuous use. Food grade.

Constant operation: -10 °C +70 °C (+14 °F +158 °F)

↔		↔		↻		↻		⤴		⤵		
mm	in	mm	in	bar	psi	bar	psi	mm	in	%	kg/m	lb/ft
12,0	15/32"	22,00	0,87	50	730	150	2250	84,0	3,31		0,340	0,23

// 351LL



Hot water wash down 10 bar (150 psi) - Built in nozzle

Tube: white EPDM.

Reinforcement: high tensile textile cords.

Cover: white EPDM - heat, abrasion and ozone resistant.

Application: hot and cold water wash down in paper mills and the food industry where a built in rubber nozzle is required to avoid floor and equipment damage.

Constant operation: -40 °C +120 °C (-40 °F +248 °F)

↔		↔		↻		↻		⤴		⤵		
mm	in	mm	in	bar	psi	bar	psi	mm	in	%	kg/m	lb/ft
19,0	3/4"	31,00	1,22	10	150	40	600				0,630	0,43
25,0	1"	37,00	1,46	10	150	40	600				0,780	0,53
32,0	1 1/4"	46,00	1,81	10	150	40	600				1,140	0,77
38,0	1 1/2"	52,00	2,05	10	150	40	600				1,340	0,91

// 351LG



Hot water wash down 10 bar (150 psi) - Built in nozzle

Tube: white EPDM.

Reinforcement: high tensile textile cords.

Cover: green EPDM - heat, abrasion and ozone resistant.

Application: hot and cold water wash down in paper mills and the food industry where a built in rubber nozzle is required to avoid floor and equipment damage.

Constant operation: -40 °C +120 °C (-40 °F +248 °F)

↔		↔		↻		↻		⤴		⤵		
mm	in	mm	in	bar	psi	bar	psi	mm	in	%	kg/m	lb/ft
19,0	3/4"	31,00	1,22	10	150	40	600				0,600	0,41
25,0	1"	37,00	1,46	10	150	40	600				0,740	0,50
32,0	1 1/4"	46,00	1,81	10	150	40	600				1,100	0,74
38,0	1 1/2"	52,00	2,05	10	150	40	600				1,290	0,87

// 350LL



Steam 6 bar (90 psi) - Hot water 15 bar (225 psi)
FDA - arrêté du 09/11/94 D

Tube: white EPDM.

Reinforcement: high tensile textile cords.

Cover: white EPDM - heat, abrasion and ozone resistant.

Application: saturated steam and hot water delivery in general industrial applications. Specially designed for wash down use in the food and dairy industry.

Also suitable for liquid food and alcoholic beverages.

Constant operation: water -40 °C +120 °C (-40 °F +248 °F)
 steam +165 °C (+330 °F)

↔		↔		↻		↻		⤴		⚖		
mm	in	mm	in	bar	psi	bar	psi	mm	in	%	kg/m	lb/ft
13,0	1/2"	23,00	0,91	6	90	60	900				0,380	0,26
16,0	5/8"	26,00	1,02	6	90	60	900				0,450	0,31
19,0	3/4"	31,00	1,22	6	90	60	900				0,640	0,44
25,0	1"	37,00	1,46	6	90	60	900				0,790	0,54

// 350LE



Steam 6 bar (90 psi) - Hot water 15 bar (225 psi)
FDA - arrêté du 09/11/94 D

Tube: white food grade EPDM.

Reinforcement: high tensile textile cords.

Cover: blue EPDM - heat, abrasion and ozone resistant.

Application: saturated steam and hot water delivery in general industrial applications. Specially designed for wash down use in the food and dairy industry.

Also suitable for liquid food and alcoholic beverages.

Constant operation: water -40 °C +120 °C (-40 °F +248 °F)
 steam +165 °C (+330 °F)

↔		↔		↻		↻		⤴		⚖		
mm	in	mm	in	bar	psi	bar	psi	mm	in	%	kg/m	lb/ft
13,0	1/2"	23,00	0,91	6	90	60	900				0,360	0,25
16,0	5/8"	26,00	1,02	6	90	60	900				0,420	0,29
19,0	3/4"	31,00	1,22	6	90	60	900				0,590	0,40
25,0	1"	37,00	1,46	6	90	60	900				0,740	0,50
32,0	1 1/4"	46,00	1,81	6	90	60	900				0,930	0,63
38,0	1 1/2"	52,00	2,05	6	90	60	900				1,090	0,74
51,0	2"	67,00	2,64	6	90	60	900				1,660	1,12

Dimensions shown may be changed without prior notice

// 350AA



Steam 6 bar (90 psi) - Hot water 15 bar (225 psi)

Tube: black conductive EPDM.

Reinforcement: high tensile textile cords.

Cover: black conductive EPDM - heat, abrasion and ozone resistant.

Application: saturated steam and hot water delivery in general industrial applications.

Constant operation: water -40 °C +120 °C (-40 °F +248 °F)
steam +165 °C (+330 °F)

↔		↔		↻		↻		⌒		⌒		⌒	
mm	in	mm	in	bar	psi	bar	psi	mm	in	%	kg/m	lb/ft	
13,0	1/2"	23,00	0,91	6	90	60	900				0,370	0,25	
16,0	5/8"	26,00	1,02	6	90	60	900				0,430	0,29	
19,0	3/4"	29,00	1,14	6	90	60	900				0,470	0,32	
25,0	1"	35,00	1,38	6	90	60	900				0,590	0,40	
30,0	1 3/16"	44,00	1,73	6	90	60	900				0,910	0,62	
32,0	1 1/4"	46,00	1,81	6	90	60	900				0,950	0,64	
38,0	1 1/2"	52,00	2,05	6	90	60	900				1,110	0,75	
40,0	1 9/16"	54,00	2,13	6	90	60	900				1,160	0,78	
51,0	2"	67,00	2,64	6	90	60	900				1,710	1,15	

// 354AA



**Steam 6 bar (90 psi)
EN ISO 6134/1A**

Tube: black conductive EPDM.

Reinforcement: high tensile textile cords.

Cover: black conductive EPDM - heat, abrasion and ozone resistant.

Application: saturated steam.

Constant operation: -40 °C +165 °C (-40 °F +330 °F)

↔		↔		↻		↻		⌒		⌒		⌒	
mm	in	mm	in	bar	psi	bar	psi	mm	in	%	kg/m	lb/ft	
13,0	1/2"	25,00	0,98	6	90	60	900	130,0	5,12		0,430	0,29	
19,0	3/4"	33,00	1,30	6	90	60	900	190,0	7,48		0,690	0,47	
25,0	1"	40,00	1,57	6	90	60	900	250,0	9,84		0,910	0,62	

// 340AA



Steam 18 bar (270 psi) - Steel braided

Tube: black conductive EPDM.

Reinforcement: one or two high tensile steel wire braids.

Cover: black conductive EPDM - heat, abrasion and ozone resistant - pin pricked.

Application: saturated and superheated steam.

Constant operation: -40 °C +210 °C (-40 °F +410 °F) intermittent to 232 °C (450 °F)

↔		↔		↻		↻		⤴		⤵		
mm	in	mm	in	bar	psi	bar	psi	mm	in	%	kg/m	lb/ft
13,0	1/2"	23,00	0,91	18	270	180	2610	130,0	5,12		0,400	0,27
19,0	3/4"	31,00	1,22	18	270	180	2610	190,0	7,48		0,730	0,50
25,0	1"	38,00	1,50	18	270	180	2610	250,0	9,84		0,890	0,60

// 340AH



Steam 18 bar (270 psi) - Steel braided

Tube: black conductive EPDM.

Reinforcement: one or two high tensile steel wire braids.

Cover: red EPDM - heat, abrasion and ozone resistant - pin pricked.

Application: saturated and superheated steam.

Constant operation: -40 °C +210 °C (-40 °F +410 °F) intermittent to 232 °C (450 °F)

↔		↔		↻		↻		⤴		⤵		
mm	in	mm	in	bar	psi	bar	psi	mm	in	%	kg/m	lb/ft
13,0	1/2"	23,00	0,91	18	270	180	2610	130,0	5,12		0,400	0,27
16,0	5/8"	26,00	1,02	18	270	180	2610	160,0	6,30		0,480	0,33
19,0	3/4"	31,00	1,22	18	270	180	2610	190,0	7,48		0,740	0,50
25,0	1"	38,00	1,50	18	270	180	2610	250,0	9,84		0,900	0,61
32,0	1 1/4"	46,00	1,81	18	270	180	2610	320,0	12,60		1,190	0,80
38,0	1 1/2"	52,00	2,05	18	270	180	2610	380,0	14,96		1,340	0,91
51,0	2"	67,00	2,64	18	270	180	2610	510,0	20,08		2,130	1,44
63,0	2 1/2"	81,00	3,19	18	270	180	2610	630,0	24,80		2,990	2,01
76,0	3"	94,00	3,70	18	270	180	2610	760,0	29,92		3,970	2,67

Dimensions shown may be changed without prior notice

// 344AH



EXTRUDED TUBE

**Steam 18 bar (270 psi) - Steel braided
EN ISO 6134/2A**

Tube: black conductive EPDM.

Reinforcement: one or two high tensile steel wire braids.

Cover: red EPDM - heat, abrasion and ozone resistant - pin pricked.

Application: saturated and superheated steam.

Constant operation: -40 °C +210 °C (-40 °F +410 °F)
intermittent to 232 °C (450 °F)

↔		↔		↙	↘	↗		↖	⚖			
mm	in	mm	in	bar	psi	bar	psi	mm	in	%	kg/m	lb/ft
13,0	1/2"	25,00	0,98	18	270	180	2610	130,0	5,12		0,490	0,33
19,0	3/4"	33,00	1,30	18	270	180	2610	190,0	7,48		0,850	0,58
25,0	1"	40,00	1,57	18	270	180	2610	250,0	9,84		1,040	0,70

// 343AH



EXTRUDED TUBE



**Steam 18 bar (270 psi) - Oil resistant - Steel braided
EN ISO 6134/2B**

Tube: black conductive EPDM.

Reinforcement: high tensile steel wire braids.

Cover: red special rubber compound - heat, abrasion, ozone and hydrocarbon resistant - pin pricked.

Application: saturated and superheated steam in applications where an oil resistant cover is required.

Black version available upon request with minimum order quantities.

Constant operation: -40 °C +210 °C (-40 °F +410 °F)
intermittent to 232 °C (450 °F)

↔		↔		↙	↘	↗		↖	⚖			
mm	in	mm	in	bar	psi	bar	psi	mm	in	%	kg/m	lb/ft
19,0	3/4"	33,00	1,30	18	270	180	2610	190,0	7,48		0,910	0,62
25,0	1"	40,00	1,57	18	270	180	2610	250,0	9,84		1,110	0,75

// 341AA



Steam 18 bar (270 psi) - CIIR - Steel braided

Tube: black conductive chlorobutyl blend.
Reinforcement: one or two high tensile steel wire braids.
Cover: black conductive EPDM - heat, abrasion and ozone resistant - pin pricked.
Application: saturated and superheated steam.
Constant operation: -40 °C +210 °C (-40 °F +410 °F) intermittent to 232 °C (450 °F)

↔		↔		↻		↻		⤴		⤵		⚖	
mm	in	mm	in	bar	psi	bar	psi	mm	in	%	kg/m	lb/ft	
13,0	1/2"	23,00	0,91	18	270	180	2610	130,0	5,12		0,400	0,27	
19,0	3/4"	31,00	1,22	18	270	180	2610	190,0	7,48		0,710	0,48	
25,0	1"	38,00	1,50	18	270	180	2610	250,0	9,84		0,870	0,59	
32,0	1 1/4"	46,00	1,81	18	270	180	2610	320,0	12,60		1,180	0,80	
38,0	1 1/2"	52,00	2,05	18	270	180	2610	380,0	14,96		1,330	0,90	
51,0	2"	67,00	2,64	18	270	180	2610	510,0	20,08		2,110	1,42	

// 341AH



Steam 18 bar (270 psi) - CIIR - Steel braided

Tube: black conductive chlorobutyl blend.
Reinforcement: one or two high tensile steel wire braids.
Cover: red EPDM - heat, abrasion and ozone resistant - pin pricked.
Application: saturated and superheated steam.
Constant operation: -40 °C +210 °C (-40 °F +410 °F) intermittent to 232 °C (450 °F)

↔		↔		↻		↻		⤴		⤵		⚖	
mm	in	mm	in	bar	psi	bar	psi	mm	in	%	kg/m	lb/ft	
13,0	1/2"	23,00	0,91	18	270	180	2610	130,0	5,12		0,400	0,27	
19,0	3/4"	31,00	1,22	18	270	180	2610	190,0	7,48		0,720	0,49	
25,0	1"	38,00	1,50	18	270	180	2610	250,0	9,84		0,880	0,60	
32,0	1 1/4"	46,00	1,81	18	270	180	2610	320,0	12,60		1,170	0,79	
38,0	1 1/2"	52,00	2,05	18	270	180	2610	380,0	14,96		1,330	0,90	
51,0	2"	67,00	2,64	18	270	180	2610	510,0	20,08		2,040	1,38	

// 345AA



Steam 18 bar (270 psi) - CIIR - Steel braided EN ISO 6134/2A

Tube: black conductive chlorobutyl blend.
Reinforcement: high tensile steel wire braids.
Cover: black EPDM - heat, abrasion and ozone resistant - pin pricked.
Application: saturated and superheated steam.
Constant operation: -40 °C +210 °C (-40 °F +410 °F) intermittent to 232 °C (450 °F)

↔		↔		↻		↻		⤴		⤵		⚖	
mm	in	mm	in	bar	psi	bar	psi	mm	in	%	kg/m	lb/ft	
19,0	3/4"	33,00	1,30	18	270	180	2610	190,0	7,48		0,840	0,57	
25,0	1"	40,00	1,57	18	270	180	2610	250,0	9,84		1,030	0,70	
51,0	2"	69,00	2,72	18	270	180	2610	510,0	20,08		2,300	1,55	

Dimensions shown may be changed without prior notice

// STEAM HOSE SAFETY GUIDE

Handling steam is a very hazardous situation. Using care and some safety precaution can minimise or eliminate personal or property damage.

(Reprinted from RMA IP-11-1 Steam Hose)

SELECTING AND USING STEAM HOSE

1. Make sure steam hose is identified as a steam hose. It should be branded as such, stating working pressure and temperature rating
2. Make sure working pressure and temperature is not exceeded
3. Do not allow hose to remain under pressure when not in use
4. Avoid excess bending or flexing of hose near the coupling. Straight line operation is preferred. If bends are necessary as part of operation, spring guards may help
5. Be sure and use recommended steam hose couplings and clamps on hose.

MAINTENANCE OF STEAM HOSE

1. Periodic inspection of hose should include looking for cover blisters and lumps
2. Check for kinked areas that could damage hose
3. Drain hose after each use to avoid tube damage before hose is put back in operation, to avoid "popcorning" of the tube
4. Check tightness of clamps bolts after each use
5. Check to see if clamps halves are touching. If they are, recouple hose with smaller clamps to insure proper tightness or grip around hose
6. Do not store hose over hooks
7. Steam hose lying on metal racks or installed around steel piping will dry out the hose, causing tube and cover cracking.

CORROSIVE STEAM

When the water used to generate steam contains dissolved air, oxygen or carbon dioxide, then these gases end up as contaminants in the steam. At high temperatures of steam both oxygen and carbon dioxide are extremely corrosive. Carbon dioxide is acidic and therefore attacks metals whereas the oxygen corrodes metals and oxidises rubbers. Corrosion of metals in the presence of both oxygen and acids is forty times faster than with either alone. Boiler water is therefore normally treated not only to remove the "hardness" which would cause "furring" of the boiler but also to remove dissolved oxygen and carbon dioxide and to ensure that the steam is not only not acidic but even slightly alkaline. Boiler water treatment is a specialised subject beyond the scope of this technical sheet but correct steam generation is important.

DETERIORATION OF STEAM HOSE

Like all rubber products steam hoses have a finite life and are subject to gradual deterioration with use. However, it sometimes happens that hoses which have been giving a good life suddenly start failing without apparent reason. In such cases it is often a change in the steam conditions causing a rapid acceleration of a normal failure mode. It is therefore useful to consider how steam hoses normally last and thus how the condition of the steam affects hose life.

TEMPERATURE OF SATURATED STEAM

Gauge Pressure		Temperature	
psi	bar	° C	° F
25	1.73	130	267
30	2.07	134	274
35	2.42	138	281
40	2.76	141	287
45	3.11	144	292
50	3.45	148	298
60	4.14	153	307
70	4.83	158	316
80	5.52	162	324
90	6.21	166	330
100	6.90	170	338
120	8.28	177	350
140	9.66	182	361
160	11.04	188	371
180	12.42	193	379
200	13.80	198	388
225	15.53	203	397
250	17.25	208	406
275	18.98	212	414
300	20.70	216	422
325	22.43	221	429
350	24.15	225	437

The chart represents the three forms of water when subjected to heat and pressure. Use only hoses specifically designed for the application.

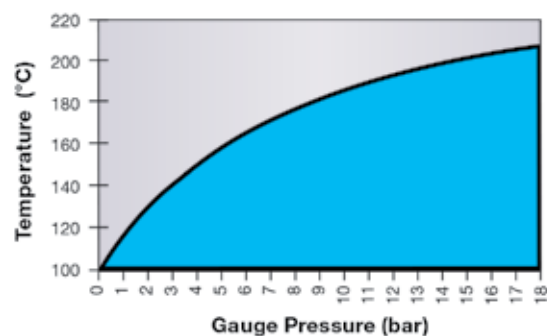





49200	General purpose food quality - PVC - FDA - EU 10/2011 A+B+C - AS 2070.....	70
4660L	General purpose S&D - PVC - Standard duty - FDA - EU 10/2011 A+B+C - AS 2070.....	70
4680H	Liquid food S&D - PVC - Heavy duty - FDA - EU 10/2011 A+B+C - AS 2070.....	71
47200	General purpose food quality S&D - PVC - FDA - EU 10/2011 A+B+C - AS 2070.....	71
452LH	Liquid food delivery 10 bar (150 psi) - FDA arrêté du 09/11/94 D.....	72
402LH	Liquid food S&D 10 bar (150 psi) - FDA arrêté du 09/11/94 D.....	72
410LL	Alcoholic beverages S&D 16 bar (240 psi) - Crush resistant - FDA arrêté du 09/11/94 D.....	73
412LE	Milk tanker 10 bar (150 psi) - Hard wall - FDA arrêté du 09/11/94 D.....	74
418LE	Milk tanker 10 bar (150 psi) - Hard wall - Crush resistant - FDA arrêté du 09/11/94 D.....	74
455LE	Fat food delivery 10 bar (150 psi) - FDA - D.M. 21/03/73.....	75
455LL	Fat food delivery 10 bar (150 psi) - FDA - D.M. 21/03/73.....	75
405LE	Fat food S&D 10 bar (150 psi) - FDA - D.M. 21/03/73.....	76
405LL	Fat food S&D 10 bar (150 psi) - FDA - D.M. 21/03/73.....	76
405LH	Fat food S&D 10 bar (150 psi) - FDA - D.M. 21/03/73.....	77
417LE	Fat food S&D 16 bar (240 psi) - Crush resistant - FDA - D.M. 21/03/73.....	77

// 49200



General purpose food quality - PVC
FDA - EU 10/2011 A+B+C - AS 2070

Tube: transparent PVC.
Reinforcement: high tensile textile cords.
Cover: transparent PVC with longitudinal red stripes - abrasion and ozone resistant.
Application: general purpose food quality. Sterilize with 5% soda solution.
Constant operation: -5 °C +60 °C (+23 °F +140 °F)

↔		↔		↻		↻		⤴		⚖		
mm	in	mm	in	bar	psi	bar	psi	mm	in	%	kg/m	lb/ft
6,0	1/4"	11,00	0,43	20	300	60	900				0,085	0,06
6,0	1/4"	12,00	0,47	20	300	60	900				0,110	0,08
8,0	5/16"	13,00	0,51	15	225	45	650				0,105	0,08
8,0	5/16"	14,00	0,55	15	225	45	650				0,130	0,09
10,0	3/8"	15,00	0,59	15	225	45	650				0,125	0,09
10,0	3/8"	16,00	0,63	15	225	45	650				0,155	0,11
13,0	1/2"	19,00	0,75	10	150	30	450				0,190	0,13
16,0	5/8"	22,00	0,87	10	150	30	450				0,225	0,16
19,0	3/4"	25,00	0,98	10	150	30	450				0,260	0,18
19,0	3/4"	26,00	1,02	10	150	30	450				0,310	0,21
25,0	1"	32,00	1,26	10	150	30	450				0,390	0,27
25,0	1"	33,00	1,30	10	150	30	450				0,450	0,31
30,0	1 3/16"	38,00	1,50	7	100	21	300				0,530	0,36
32,0	1 1/4"	42,00	1,65	7	100	21	300				0,715	0,49
38,0	1 1/2"	48,00	1,89	7	100	21	300				0,830	0,56
51,0	2"	63,00	2,48	6	90	18	270				1,330	0,90

// 4660L



General purpose S&D - PVC - Standard duty
FDA - EU 10/2011 A+B+C - AS 2070

Construction: transparent PVC - abrasion and ozone resistant.
Reinforcement: white shock resistant rigid PVC.
Application: general purpose liquid food and alcoholic beverages suction and delivery - max 20% - Sterilize with 5% soda solution.
Constant operation: -5 °C +60 °C (+23 °F +140 °F)

↔		↔		↻		↻		⤴		⚖		
mm	in	mm	in	bar	psi	bar	psi	mm	in	%	kg/m	lb/ft
20,0	13/16"			8	120	24	350	90,0	3,54	70	0,230	0,16
25,0	1"			8	120	24	350	113,0	4,45	70	0,290	0,20
30,0	1 3/16"			7	100	21	300	135,0	5,31	70	0,360	0,25
32,0	1 1/4"			7	100	21	300	144,0	5,67	70	0,390	0,27
35,0	1 3/8"			7	100	21	300	158,0	6,22	70	0,440	0,30
38,0	1 1/2"			6	90	18	270	171,0	6,73	70	0,510	0,35
40,0	1 9/16"			6	90	18	270	180,0	7,09	70	0,540	0,37
45,0	1 3/4"			6	90	18	270	203,0	7,99	70	0,670	0,46
51,0	2"			5	75	15	225	230,0	9,06	70	0,760	0,52
55,0	2 1/6"			5	75	15	225	247,0	9,72	70	0,810	0,55
60,0	2 3/8"			5	75	15	225	270,0	10,63	70	0,920	0,62
63,0	2 1/2"			5	75	15	225	284,0	11,18	70	0,970	0,66
70,0	2 3/4"			5	75	15	225	315,0	12,40	70	1,160	0,78
76,0	3"			5	75	15	225	342,0	13,46	70	1,330	0,90
80,0	3 1/8"			4	60	12	180	360,0	14,17	70	1,450	0,98
90,0	3 1/2"			4	60	12	180	405,0	15,94	70	1,800	1,21
102,0	4"			4	60	12	180	459,0	18,07	70	2,190	1,48
120,0	4 3/4"			3	45	9	135	540,0	21,26	50	2,700	1,82

Dimensions shown may be changed without prior notice

// 4680H



Liquid food S&D - PVC - Heavy duty
FDA - EU 10/2011 A+B+C - AS 2070

Construction: transparent PVC - abrasion and ozone resistant.
Reinforcement: red shock resistant rigid PVC.
Application: liquid food and alcoholic beverages suction and delivery - max 20%. Sterilize with 5% soda solution.
Constant operation: -5 °C +60 °C (+23 °F +140 °F)

↔		↔		↻		↻		⤴		⚠		⚖	
mm	in	mm	in	bar	psi	bar	psi	mm	in	%	kg/m	lb/ft	
25,0	1"			7	100	21	300	125,0	4,92	90	0,405	0,28	
32,0	1 1/4"			7	100	21	300	160,0	6,30	90	0,530	0,36	
38,0	1 1/2"			7	100	21	300	190,0	7,48	90	0,745	0,51	
40,0	1 9/16"			7	100	21	300	200,0	7,87	90	0,765	0,52	
51,0	2"			7	100	21	300	255,0	10,04	90	1,015	0,69	
60,0	2 3/8"			7	100	21	300	300,0	11,81	90	1,475	1,00	
63,0	2 1/2"			6	90	18	270	315,0	12,40	90	1,525	1,03	
76,0	3"			5	75	15	225	380,0	14,96	90	1,930	1,30	
80,0	3 1/8"			5	75	15	225	400,0	15,75	90	2,135	1,44	
102,0	4"			4	60	12	180	510,0	20,08	90	3,355	2,26	
120,0	4 3/4"			3	45	9	135	600,0	23,62	80	3,645	2,45	

// 47200



General purpose food quality S&D - PVC
FDA - EU 10/2011 A+B+C - AS 2070

Construction: transparent PVC - abrasion and ozone resistant.
Reinforcement: Steel helix wire.
Application: general purpose liquid food and alcoholic beverages suction and delivery - max 20% - Sterilize with 5% soda solution.
Constant operation: -5 °C +60 °C (+23 °F +140 °F)

↔		↔		↻		↻		⤴		⚠		⚖	
mm	in	mm	in	bar	psi	bar	psi	mm	in	%	kg/m	lb/ft	
10,0	3/8"	16,00	0,63	15	225	45	650	40,0	1,57	90	0,160	0,11	
13,0	1/2"	19,00	0,75	7	100	21	300	52,0	2,05	85	0,195	0,14	
14,0	9/16"	20,00	0,79	6	90	18	270	56,0	2,20	85	0,210	0,15	
16,0	5/8"	22,00	0,87	6	90	18	270	64,0	2,52	85	0,250	0,17	
18,0	23/32"	25,00	0,98	6	90	18	270	72,0	2,83	85	0,300	0,21	
20,0	13/16"	27,00	1,06	5	75	15	225	80,0	3,15	85	0,330	0,23	
22,0	7/8"	29,00	1,14	5	75	15	225	88,0	3,46	85	0,380	0,26	
25,0	1"	33,00	1,30	5	75	15	225	100,0	3,94	85	0,515	0,35	
30,0	1 3/16"	38,00	1,50	4	60	12	180	120,0	4,72	85	0,610	0,41	
32,0	1 1/4"	40,00	1,57	4	60	12	180	128,0	5,04	85	0,650	0,44	
35,0	1 3/8"	44,00	1,73	4	60	12	180	140,0	5,51	85	0,785	0,53	
38,0	1 1/2"	47,00	1,85	4	60	12	180	152,0	5,98	85	0,810	0,55	
40,0	1 9/16"	49,00	1,93	3	45	9	135	160,0	6,30	85	0,885	0,60	
45,0	1 3/4"	55,00	2,17	3	45	9	135	180,0	7,09	80	1,100	0,74	
51,0	2"	61,00	2,40	3	45	9	135	204,0	8,03	80	1,230	0,83	
60,0	2 3/8"	72,00	2,83	2	30	6	90	240,0	9,45	80	1,700	1,15	
63,0	2 1/2"	75,00	2,95	2	30	6	90	252,0	9,92	80	1,775	1,20	
70,0	2 3/4"	84,00	3,31	2	30	6	90	280,0	11,02	80	2,030	1,37	
76,0	3"	90,00	3,54	2	30	6	90	304,0	11,97	70	2,350	1,58	
80,0	3 1/8"	94,00	3,70	2	30	6	90	320,0	12,60	70	2,500	1,69	
90,0	3 1/2"	104,00	4,09	2	30	6	90	360,0	14,17	70	3,000	2,02	
102,0	4"	116,00	4,57	2	30	6	90	408,0	16,06	70	3,480	2,34	
105,0	4 1/8"	121,00	4,76	3	45	9	135	420,0	16,54	90	4,250	2,86	
152,0	6"	172,00	6,77	2	30	6	90	608,0	23,94	70	7,200	4,84	

// 452LH



**Liquid food delivery 10 bar (150 psi)
FDA arrêté du 09/11/94 D**

Tube: white NR.
Reinforcement: high tensile textile cords.
Cover: red NBR/PVC - abrasion and ozone resistant.
Application: liquid food and alcoholic beverages delivery - max 50%. Sterilize with 110 °C (230 °F) steam for 10 minutes or with 5% soda solution.
Constant operation: -30 °C +80 °C (-22 °F +176 °F)

↔		↔		↻		↻		↵		⚖		
mm	in	mm	in	bar	psi	bar	psi	mm	in	%	kg/m	lb/ft
13,0	1/2"	23,00	0,91	10	150	30	450				0,380	0,26
19,0	3/4"	31,00	1,22	10	150	30	450				0,610	0,41
25,0	1"	37,00	1,46	10	150	30	450				0,760	0,52
32,0	1 1/4"	44,00	1,73	10	150	30	450				0,930	0,63
38,0	1 1/2"	50,00	1,97	10	150	30	450				1,080	0,73
51,0	2"	65,00	2,56	10	150	30	450				1,690	1,14
63,0	2 1/2"	77,00	3,03	10	150	30	450				2,030	1,37
76,0	3"	92,00	3,62	10	150	30	450				2,810	1,89

// 402LH



**Liquid food S&D 10 bar (150 psi)
FDA arrêté du 09/11/94 D**

Tube: white NR.
Reinforcement: high tensile textile cords with embedded steel helix wire.
Cover: red NBR/PVC - abrasion and ozone resistant.
Application: liquid food and alcoholic beverages suction and delivery - max 50%. Special construction for maximum flexibility. Sterilize with 110 °C (230 °F) steam for 10 minutes or with 5% soda solution.
Constant operation: -30 °C +80 °C (-22 °F +176 °F)

↔		↔		↻		↻		↵		⚖		
mm	in	mm	in	bar	psi	bar	psi	mm	in	%	kg/m	lb/ft
25,0	1"	37,00	1,46	10	150	30	450	75,0	2,95	100	0,910	0,62
38,0	1 1/2"	50,00	1,97	10	150	30	450	114,0	4,49	100	1,260	0,85
51,0	2"	63,00	2,48	10	150	30	450	153,0	6,02	100	1,620	1,09
76,0	3"	88,00	3,46	10	150	30	450	228,0	8,98	90	2,550	1,72
102,0	4"	116,00	4,57	10	150	30	450	306,0	12,05	90	3,540	2,38

Dimensions shown may be changed without prior notice

// 410LL



IANESCO

**Alcoholic beverages S&D 16 bar (240 psi) -
Crush resistant
FDA arrêté du 09/11/94 D**
Tube: white chlorobutyl.**Reinforcement:** high tensile textile cords with embedded PET helix.**Cover:** white EPDM - abrasion and ozone resistant.**Application:** liquid food and alcoholic beverages suction and delivery - max 95%. Special crush resistant construction.

Sterilize with 130 °C (266 °F) steam for 30 minutes or with 5% soda solution.

Constant operation: -30 °C +108 °C (-22 °F +226 °F)

mm	in	mm	in	bar	psi	bar	psi	mm	in	%	kg/m	lb/ft	
25,0	1"	37,00	1,46	16	240	48	720	100,0	3,94	100	0,870	0,59	
38,0	1 1/2"	52,00	2,05	16	240	48	720	152,0	5,98	100	1,470	0,99	
51,0	2"	65,00	2,56	16	240	48	720	204,0	8,03	100	1,900	1,28	
76,0	3"	92,00	3,62	16	240	48	720	304,0	11,97	100	3,210	2,16	

// 412LE



IANESCO



**Milk tanker 10 bar (150 psi) - Hard wall
FDA arrêté du 09/11/94 D**

Tube: white NR.

Reinforcement: high tensile textile cords with embedded steel helix wire.

Cover: blue NR/EPDM - abrasion and ozone resistant.

Application: liquid food suction and delivery. Special construction for maximum flexibility in milk tanker applications. Sterilize with 110 °C (230 °F) steam for 10 minutes or with 5% soda solution.

Constant operation: -40 °C +80 °C (-40 °F +176 °F)

↔		↔		↻		↻		↵		⚖		
mm	in	mm	in	bar	psi	bar	psi	mm	in	%	kg/m	lb/ft
25,0	1"	35,00	1,38	10	150	30	450	50,0	1,97	100	0,660	0,45
32,0	1 1/4"	42,00	1,65	10	150	30	450	64,0	2,52	100	0,810	0,55
38,0	1 1/2"	48,00	1,89	10	150	30	450	76,0	2,99	100	0,940	0,64
40,0	1 9/16"	50,00	1,97	10	150	30	450	80,0	3,15	100	0,980	0,66
42,0	1 5/8"	52,00	2,05	10	150	30	450	84,0	3,31	100	1,030	0,70
51,0	2"	61,00	2,40	10	150	30	450	102,0	4,02	100	1,220	0,82
63,0	2 1/2"	75,00	2,95	10	150	30	450	126,0	4,96	100	1,860	1,26
76,0	3"	88,00	3,46	10	150	30	450	152,0	5,98	90	2,420	1,63
102,0	4"	116,00	4,57	10	150	30	450	204,0	8,03	90	3,630	2,44

// 418LE



IANESCO



**Milk tanker 10 bar (150 psi) - Hard wall - Crush resistant
FDA arrêté du 09/11/94 D**

Tube: white NR.

Reinforcement: high tensile textile cords with embedded PET helix.

Cover: blue NR/EPDM - abrasion and ozone resistant.

Application: liquid food suction and delivery. Special lightweight construction for maximum flexibility and crush resistance in milk tanker applications. Sterilize with 110 °C (230 °F) steam for 10 minutes or with 5% soda solution.

Constant operation: -40 °C +80 °C (-40 °F +176 °F)

↔		↔		↻		↻		↵		⚖		
mm	in	mm	in	bar	psi	bar	psi	mm	in	%	kg/m	lb/ft
40,0	1 9/16"	53,00	2,09	10	150	30	450	120,0	4,72	70	1,060	0,72
51,0	2"	64,00	2,52	10	150	30	450	153,0	6,02	70	1,310	0,89
63,0	2 1/2"	76,00	2,99	10	150	30	450	189,0	7,44	70	1,930	1,30
76,0	3"	92,00	3,62	10	150	30	450	228,0	8,98	70	2,630	1,77

Dimensions shown may be changed without prior notice

// 455LE



**Fat food delivery 10 bar (150 psi)
FDA - D.M. 21/03/73**

Tube: white NBR.

Reinforcement: high tensile textile cords.

Cover: blue NBR/PVC - abrasion, ozone and oil resistant.

Application: liquid and fat food-alcoholic beverages delivery - max 75%. Sterilize with 130 °C (266 °F) steam for 30 minutes or with 5% soda solution.

Constant operation: -30 °C +100 °C (-22 °F +212 °F)

↔		↔		↙		↘		↵		⚠	⚖	
mm	in	mm	in	bar	psi	bar	psi	mm	in	%	kg/m	lb/ft
13,0	1/2"	23,00	0,91	10	150	30	450				0,380	0,26
19,0	3/4"	31,00	1,22	10	150	30	450				0,610	0,41
25,0	1"	37,00	1,46	10	150	30	450				0,760	0,52
32,0	1 1/4"	44,00	1,73	10	150	30	450				0,930	0,63
38,0	1 1/2"	50,00	1,97	10	150	30	450				1,090	0,74
51,0	2"	65,00	2,56	10	150	30	450				1,690	1,14

// 455LL



**Fat food delivery 10 bar (150 psi)
FDA - D.M. 21/03/73**

Tube: white NBR.

Reinforcement: high tensile textile cords.

Cover: white NBR/PVC - abrasion, ozone and oil resistant.

Application: liquid and fat food-alcoholic beverages delivery - max 75%. Sterilize with 130 °C (266 °F) steam for 30 minutes or with 5% soda solution.

Constant operation: -30 °C +100 °C (-22 °F +212 °F)

↔		↔		↙		↘		↵		⚠	⚖	
mm	in	mm	in	bar	psi	bar	psi	mm	in	%	kg/m	lb/ft
38,0	1 1/2"	48,00	1,89	10	150	30	450				0,880	0,60
51,0	2"	63,00	2,48	10	150	30	450				1,410	0,95
76,0	3"	88,00	3,46	10	150	30	450				2,050	1,38

// 405LE



**Fat food S&D 10 bar (150 psi)
FDA - D.M. 21/03/73**

Tube: white NBR.

Reinforcement: high tensile textile cords with embedded steel helix wire.

Cover: blue NBR/PVC - abrasion, ozone and oil resistant.

Application: liquid and fat food-alcoholic beverages suction and delivery - max 75%. Sterilize with 130 °C (266 °F) steam for 30 minutes or with 5% soda solution.

Constant operation: -30 °C +100 °C (-22 °F +212 °F)

↔		↔		↻		↻		⌒		⌒		
mm	in	mm	in	bar	psi	bar	psi	mm	in	%	kg/m	lb/ft
19,0	3/4"	31,00	1,22	10	150	30	450	57,0	2,24	100	0,730	0,50
25,0	1"	37,00	1,46	10	150	30	450	75,0	2,95	100	0,910	0,62
32,0	1 1/4"	44,00	1,73	10	150	30	450	96,0	3,78	100	1,080	0,73
38,0	1 1/2"	50,00	1,97	10	150	30	450	114,0	4,49	100	1,260	0,85
51,0	2"	63,00	2,48	10	150	30	450	153,0	6,02	100	1,630	1,10
63,0	2 1/2"	75,00	2,95	10	150	30	450	189,0	7,44	90	2,140	1,44
76,0	3"	88,00	3,46	10	150	30	450	228,0	8,98	90	2,570	1,73
102,0	4"	116,00	4,57	10	150	30	450	306,0	12,05	90	3,560	2,40

// 405LL



**Fat food S&D 10 bar (150 psi)
FDA - D.M. 21/03/73**

Tube: white NBR.

Reinforcement: high tensile textile cords with embedded steel helix wire.

Cover: white NBR/PVC - abrasion, ozone and oil resistant.

Application: liquid and fat food-alcoholic beverages suction and delivery - max 75%. Sterilize with 130 °C (266 °F) steam for 30 minutes or with 5% soda solution.

Constant operation: -30 °C +100 °C (-22 °F +212 °F)

↔		↔		↻		↻		⌒		⌒		
mm	in	mm	in	bar	psi	bar	psi	mm	in	%	kg/m	lb/ft
19,0	3/4"	31,00	1,22	10	150	30	450	57,0	2,24	100	0,730	0,50
25,0	1"	37,00	1,46	10	150	30	450	75,0	2,95	100	0,910	0,62
32,0	1 1/4"	44,00	1,73	10	150	30	450	96,0	3,78	100	1,080	0,73
38,0	1 1/2"	50,00	1,97	10	150	30	450	114,0	4,49	100	1,260	0,85
51,0	2"	63,00	2,48	10	150	30	450	153,0	6,02	100	1,630	1,10
63,0	2 1/2"	75,00	2,95	10	150	30	450	189,0	7,44	90	2,140	1,44
76,0	3"	88,00	3,46	10	150	30	450	228,0	8,98	90	2,570	1,73
102,0	4"	116,00	4,57	10	150	30	450	306,0	12,05	90	3,560	2,40

Dimensions shown may be changed without prior notice

// 405LH



**Fat food S&D 10 bar (150 psi)
FDA - D.M. 21/03/73**

Tube: white NBR.
Reinforcement: high tensile textile cords with embedded steel helix wire.
Cover: red NBR/PVC - abrasion, ozone and oil resistant.
Application: liquid and fat food-alcoholic beverages suction and delivery - max 75%. Sterilize with 130 °C (266 °F) steam for 30 minutes or with 5% soda solution.
Constant operation: -30 °C +100 °C (-22 °F +212 °F)

↔		↔		↻		↻		⤴		⤵		
mm	in	mm	in	bar	psi	bar	psi	mm	in	%	kg/m	lb/ft
25,0	1"	37,00	1,46	10	150	30	450	75,0	2,95	100	0,920	0,62
38,0	1 1/2"	50,00	1,97	10	150	30	450	114,0	4,49	100	1,280	0,87
51,0	2"	63,00	2,48	10	150	30	450	153,0	6,02	100	1,650	1,11
76,0	3"	88,00	3,46	10	150	30	450	228,0	8,98	90	2,590	1,75
102,0	4"	116,00	4,57	10	150	30	450	306,0	12,05	90	3,600	2,42

// 417LE



**Fat food S&D 16 bar (240 psi) - Crush resistant
FDA - D.M. 21/03/73**







Tube: white NBR.
Reinforcement: high tensile textile cords with embedded PET helix.
Cover: blue NBR/PVC - abrasion, ozone and oil resistant.
Application: liquid and fat food-alcoholic beverages suction and delivery - max 75%. Special crush resistant construction. Sterilize with 130 °C (266 °F) steam for 30 minutes or with 5% soda solution.
Constant operation: -30 °C +100 °C (-22 °F +212 °F)

↔		↔		↻		↻		⤴		⤵		
mm	in	mm	in	bar	psi	bar	psi	mm	in	%	kg/m	lb/ft
38,0	1 1/2"	52,00	2,05	16	240	48	720	152,0	5,98	100	1,440	0,97
51,0	2"	65,00	2,56	16	240	48	720	204,0	8,03	100	1,860	1,26
63,0	2 1/2"	77,00	3,03	16	240	48	720	252,0	9,92	100	2,390	1,61
76,0	3"	92,00	3,62	16	240	48	720	304,0	11,97	100	3,120	2,10













// HOSE IDENTIFICATION TABLE

TECHNICAL FEATURES AND NORMS										
HOSE	TUBE	MAX TEMP. (°C)	WP (bar)	STERILIZATION	 PHTHALATE FREE	 FDA TITLE 21	 2004/1935 EC	 10/2011 EC	 2006/2023 EC	FRANCE 1994/11/09 CAT. D

PVC HOSE

	49000	PVC	+60		5% Soda	●	●				
	49200	PVC	+60	Max 20	5% Soda	●	●	●	A+B+C	●	
	4660L	PVC	+60	Max 8	5% Soda	●	●	●	A+B+C	●	
	4680H	PVC	+60	Max 7	5% Soda	●	●	●	A+B+C	●	
	47200	PVC	+60	Max 15	5% Soda	●	●	●	A+B+C	●	
	395BT	PVC	+70	50		●		●	A+B+C	●	

RUBBER HOSE

	350LE	EPDM	+165	15 Water 6 Steam		●	●	●		●	IANESCO
	452LH	NR	+80	10	Steam 110°C / 10' 5% Soda	●	●	●		●	IANESCO
	402LH	NR	+80	10	Steam 110°C / 10' 5% Soda	●	●	●		●	IANESCO
	410LL	CIIR	+108	16	Steam 130°C / 30' 5% Soda	●	●	●		●	IANESCO
	412LE	NR	+80	10	Steam 110°C / 10' 5% Soda	●	●	●		●	IANESCO
	418LE	NR	+80	10	Steam 110°C / 10' 5% Soda	●	●	●		●	IANESCO
	455LE	NBR	+100	10	Steam 130°C / 30' 5% Soda	●	●	●		●	
	405LE	NBR	+100	10	Steam 130°C / 30' 5% Soda	●	●	●		●	
	417LE	NBR	+100	16	Steam 130°C / 30' 5% Soda	●	●	●		●	
	5090E	UPE	+100	16	Steam 110°C / 10' 5% Soda	●	●	●	A+B+C+D2	●	
	720LA	NR	+80	10	5% Soda	●	●				
	760LA	NR	+80	5	5% Soda	●	●				

Dimensions shown may be changed without prior notice

ITALY D.M. 21/03/73	ALCOHOLIC BEVERAGES				DAIRY INDUSTRY		FOOD INDUSTRY			CLEANING
	≤20%	≤50%	≤75%	≤95%	MILK COLLECTING	MILK TRANSPORT	JUICES, SODAS, SAUCES, SOUPS WITH ACIDITY CONTENT	LIQUID FOOD	FAT FOOD	BULK FOOD

								•			
	•							•			
	•							•			
	•							•			
	•							•			
								•			•

		•						•			•
		•						•			
		•						•			
				•			•	•			
					•	•		•			
					•	•		•			
CERISIE			•				•	•	•		
CERISIE			•				•	•	•		
CERISIE			•				•	•	•		
				•			•	•	•	•	
										•	
										•	

// FULL COMPLIANCE WITH EUROPEAN REGULATIONS

ALFAGOMMA offers a wide range of rubber and PVC hoses for food transfer fully complying with the existing regulations for materials in contact with food:

EC 1935/2004

General requirements for materials that come into contact with food.

ALFAGOMMA food hoses are specifically developed to meet the migration limits so as not to endanger human health, change the food composition or deteriorate the taste and odour of food.

EC 2023/2006

Good manufacturing practice for materials and articles intended to come into contact with food

ALFAGOMMA has thorough quality assurance and control systems

EU 10/2011

Requirements for plastic materials, restrictions on the use of phthalates, use of specific simulants depending on food types:

	SIMULANT	FOOD
A	ethanol 10%	aqueous foods
B	acetic acid 3%	acidic foods
C	ethanol 20%	alcoholic foods up to an alcoholic content of 20%
D1	ethanol 50%	alcoholic foods with an alcoholic content of above 20% and milk products
D2	vegetable oil	fat foods
E	MPPO (Tenax)	dry foods

ALFAGOMMA food hoses are totally phthalate and bisphenol A free.

NATIONAL LEGISLATIONS OF EU MEMBER STATES

ALFAGOMMA rubber food hoses are tested by approved external laboratory according to the most important european national provisions.

ACCORDING TO EC 1935/2004, THE FULL RANGE OF AG FOOD HOSES BEAR THE "GLASS AND FORK"  SYMBOL ON THE BRAND.

Dimensions shown may be changed without prior notice

// CLEANING GUIDELINES FOR ALFAGOMMA RUBBER FOOD HOSE

Alfagomma cleaning instructions are guidelines only.

Possible national government regulations supersede the following suggestions regarding food hose cleaning. The frequency and time of the cleaning operations could affect the life of the hose.

Users should regularly check the physical and mechanical conditions of the hose.

CLEANING BEFORE FIRST USE

Hose	Prewash	Cleaning			Final Wash	
		Media	Max Concentration	Max Temperature		Max Exposure Time
452LH 402LH 412LE 418LE 509OE 720LA 760LA 455LE 405LE 417LE 410LL	Drinking Water 80 °C 10 min	Steam	—	110 °C	30 min	Drinking Water 80 °C 10 min
Sodium Hydroxide		2%	40 °C	—		
		5%	20 °C			

STANDARD CLEANING

Hose	Cleaning			Final Wash	
	Media	Max Concentration	Max Temperature		Max Exposure Time
452LH 402LH 412LE 418LE	Steam	—	110 °C	10 min	Drinking Water 80 °C 10 min
509OE 720LA 760LA	Sodium Hydroxide	2%	40 °C	—	
		5%	20 °C		
455LE 405LE	Steam	—	130 °C	30 min	
417LE 410LL	Sodium Hydroxide	2%	40 °C	—	
		5%	20 °C		

**BEFORE USING ALTERNATIVE MEDIA, PLEASE CONTACT ALFAGOMMA.
AVOID HIGH PRESSURE CLEANING OF THE HOSE TUBE.**



// BULK FOOD



760LA	Bulk food delivery 5 bar (75 psi) - FDA.....	83
760LB	Bulk food delivery 5 bar (75 psi) - FDA.....	83
720LA	Bulk food S&D 10 bar (150 psi) - FDA.....	84
720LG	Bulk food S&D 10 bar (150 psi) - FDA.....	84
967OE	Fish handling - PVC - Super elastic.....	85
949AA	Fish pump 3 bar (45 psi).....	85

Dimensions shown may be changed without prior notice

// 760LA



**Bulk food delivery 5 bar (75 psi)
FDA**

Tube: white NR - abrasion resistant.
Reinforcement: high tensile textile cords - antistatic wire.
Cover: black conductive SBR/NR - abrasion and ozone resistant.
Application: bulk food and material delivery. Specially designed for grain, flour and plastic pellets transfer.
Constant operation: -30 °C +80 °C (-22 °F +176 °F)

↔		↔		↙		↘		↵		%		⚖	
mm	in	mm	in	bar	psi	bar	psi	mm	in		kg/m	lb/ft	
75,0	3"	93,00	3,66	5	75	15	225				2,370	1,60	
90,0	3 1/2"	102,00	4,02	5	75	15	225				2,120	1,43	
100,0	4"	120,00	4,72	5	75	15	225				3,550	2,39	
102,0	4"	120,00	4,72	5	75	15	225				3,170	2,14	
110,0	4 5/16"	122,00	4,80	5	75	15	225				2,540	1,71	

// 760LB



**Bulk food delivery 5 bar (75 psi)
FDA**

Tube: white NR - abrasion resistant.
Reinforcement: high tensile textile cords - antistatic wire.
Cover: grey SBR/EPDM - abrasion and ozone resistant.
Application: bulk food and material delivery. Specially designed for grain, flour and plastic pellets transfer.
Constant operation: -30 °C +80 °C (-22 °F +176 °F)

↔		↔		↙		↘		↵		%		⚖	
mm	in	mm	in	bar	psi	bar	psi	mm	in		kg/m	lb/ft	
102,0	4"	118,00	4,65	5	75	15	225				3,140	2,12	

// 720LA



**Bulk food S&D 10 bar (150 psi)
FDA**

Tube: white NR - abrasion resistant.
Reinforcement: high tensile textile cords with embedded steel helix wire - antistatic wire.
Cover: black conductive SBR/NR - abrasion and ozone resistant.
Application: bulk food and material suction and delivery. Specially designed for grain, flour and plastic pellets transfer.
Constant operation: -30 °C +80 °C (-22 °F +176 °F)

↔		↔		↙		↘		⤴		⤵		
mm	in	mm	in	bar	psi	bar	psi	mm	in	%	kg/m	lb/ft
76,0	3"	92,00	3,62	10	150	30	450	228,0	8,98	90	2,680	1,81
90,0	3 1/2"	106,00	4,17	10	150	30	450	270,0	10,63	90	3,330	2,24
102,0	4"	118,00	4,65	10	150	30	450	306,0	12,05	90	3,700	2,49

// 720LG



**Bulk food S&D 10 bar (150 psi)
FDA**

Tube: white NR - abrasion resistant.
Reinforcement: high tensile textile cords with embedded steel helix wire - antistatic wire.
Cover: green NBR/PVC - abrasion and ozone resistant.
Application: bulk food and material suction and delivery. Specially designed for grain, flour and plastic pellets transfer.
Constant operation: -30 °C +80 °C (-22 °F +176 °F)

↔		↔		↙		↘		⤴		⤵		
mm	in	mm	in	bar	psi	bar	psi	mm	in	%	kg/m	lb/ft
51,0	2"	67,00	2,64	10	150	30	450	153,0	6,02	100	1,830	1,23
76,0	3"	92,00	3,62	10	150	30	450	228,0	8,98	90	2,840	1,91
102,0	4"	118,00	4,65	10	150	30	450	306,0	12,05	90	3,910	2,63
127,0	5"	145,00	5,71	5	75	15	225	508,0	20,00	80	5,680	3,82
152,0	6"	170,00	6,69	5	75	15	225	608,0	23,94	80	7,050	4,74
203,0	8"	223,00	8,78	5	75	15	225	812,0	31,97	70	10,470	7,04

Dimensions shown may be changed without prior notice

// 9670E



Fish handling - PVC - Super elastic

Construction: transparent PVC - abrasion and ozone resistant.
Reinforcement: light blue shock resistant rigid PVC.
Application: fish transfer on fish farms.
Constant operation: -20 °C +60 °C (-4 °F +140 °F)

↔		↔		↻		↻		⤴		⚖		
mm	in	mm	in	bar	psi	bar	psi	mm	in	%	kg/m	lb/ft
152,0	6"			2	30	6	90	380,0	14,96	95	5,600	3,77
203,0	8"			2	30	6	90	609,0	23,98	95	9,200	6,19
254,0	10"			2	30	6	90	1016,0	40,00	95	14,500	9,75
305,0	12"			1	15	3	45	1525,0	60,04	95	19,000	12,77

// 949AA



Fish pump 3 bar (45 psi)

Tube: black NBR - oil, abrasion and sea water resistant.
Reinforcement: high tensile textile cords.
Cover: black conductive CR - oil, abrasion, ozone and sea water resistant.
Application: fish transfer from fishing net to ship deck.
Constant operation: -30 °C +80 °C (-22 °F +176 °F)

↔		↔		↻		↻		⤴		⚖		
mm	in	mm	in	bar	psi	bar	psi	mm	in	%	kg/m	lb/ft
254,0	10"	262,00	10,31	3	45	10	150				4,800	3,23
305,0	12"	313,00	12,32	3	45	10	150				5,740	3,86
355,0	14"	367,00	14,45	3	45	10	150				9,020	6,07
406,0	16"	418,00	16,46	3	45	10	150				10,890	7,32
457,0	18"	469,00	18,46	3	45	10	150				12,380	8,32
508,0	20"	522,00	20,55	3	45	10	150				14,330	9,64



// BULK MATERIAL



760AA	Bulk material delivery 5 bar (75 psi).....	87
766AA	Bulk material delivery 10 bar (150 psi).....	87
720AA	Bulk material S&D 10 bar (150 psi).....	88
767AL	Bulk material S&D - PVC - Polyurethane lined.....	88
780AA	Bulk material S&D - PVC.....	89

Dimensions shown may be changed without prior notice

// 760AA



Bulk material delivery 5 bar (75 psi)

Tube: black conductive NR - abrasion resistant.

Reinforcement: high tensile textile cords.

Cover: black conductive SBR/NR - abrasion and ozone resistant.

Application: bulk material delivery. Specially designed for dry cement, grain and animal feed transfer.

Constant operation: -30 °C +80 °C (-22 °F +176 °F)

↔		↔		↻		↻		↷		⚖		
mm	in	mm	in	bar	psi	bar	psi	mm	in	%	kg/m	lb/ft
75,0	3"	93,00	3,66	5	75	15	225				2,310	1,56
90,0	3 1/2"	102,00	4,02	5	75	15	225				2,060	1,39
90,0	3 1/2"	110,00	4,33	5	75	15	225				3,140	2,12
100,0	4"	120,00	4,72	5	75	15	225				3,450	2,32
102,0	4"	114,00	4,49	5	75	15	225				2,310	1,56
102,0	4"	118,00	4,65	5	75	15	225				2,710	1,83
102,0	4"	120,00	4,72	5	75	15	225				3,130	2,11
110,0	4 5/16"	122,00	4,80	5	75	15	225				2,470	1,66
127,0	5"	145,00	5,71	5	75	15	225				3,800	2,56

// 766AA



Bulk material delivery 10 bar (150 psi)

Tube: black conductive NR - abrasion resistant.

Reinforcement: high tensile textile cords.

Cover: black conductive SBR/NR - abrasion and ozone resistant.

Application: bulk material delivery in heavy duty applications. Specially designed for dry cement, grain and animal feed transfer.

Constant operation: -30 °C +80 °C (-22 °F +176 °F)

↔		↔		↻		↻		↷		⚖		
mm	in	mm	in	bar	psi	bar	psi	mm	in	%	kg/m	lb/ft
76,0	3"	92,00	3,62	10	150	30	450				2,120	1,43
102,0	4"	118,00	4,65	10	150	30	450				2,860	1,93
127,0	5"	143,00	5,63	10	150	30	450				3,530	2,38

// 720AA



Bulk material S&D 10 bar (150 psi)

Tube: black conductive NR - abrasion resistant.

Reinforcement: high tensile textile cords with embedded steel helix wire.

Cover: black conductive SBR/NR - abrasion and ozone resistant.

Application: bulk material suction and delivery in heavy duty applications. Specially designed for dry cement, grain and animal feed transfer.

Constant operation: -30 °C +80 °C (-22 °F +176 °F)

↔		↔		↻		↻		⌒		⌒		⌒	
mm	in	mm	in	bar	psi	bar	psi	mm	in	%	kg/m	lb/ft	
51,0	2"	65,00	2,56	10	150	30	450	153,0	6,02	100	1,430	0,97	
63,0	2 1/2"	77,00	3,03	10	150	30	450	189,0	7,44	90	1,900	1,28	
76,0	3"	90,00	3,54	10	150	30	450	228,0	8,98	90	2,280	1,54	
76,0	3"	92,00	3,62	10	150	30	450	228,0	8,98	90	2,600	1,75	
90,0	3 1/2"	106,00	4,17	10	150	30	450	270,0	10,63	90	3,230	2,18	
102,0	4"	116,00	4,57	10	150	30	450	306,0	12,05	90	3,180	2,14	
102,0	4"	118,00	4,65	10	150	30	450	306,0	12,05	90	3,600	2,42	
127,0	5"	143,00	5,63	5	75	15	225	508,0	20,00	80	4,750	3,20	
127,0	5"	145,00	5,71	5	75	15	225	508,0	20,00	80	5,270	3,55	
152,0	6"	168,00	6,61	5	75	15	225	608,0	23,94	80	5,950	4,00	
203,0	8"	221,00	8,70	5	75	15	225	812,0	31,97	70	8,990	6,05	

// 767AL



Bulk material S&D - PVC - Polyurethane lined

Construction: black antistatic polyurethane coextruded with black PVC - abrasion and ozone resistant.

Reinforcement: white shock resistant rigid PVC.

Application: bulk material suction and low pressure delivery-gravity feed. Specially designed for gravel, cement and iron ore transfer.

Constant operation: -20 °C +60 °C (-4 °F +140 °F)

↔		↔		↻		↻		⌒		⌒		⌒	
mm	in	mm	in	bar	psi	bar	psi	mm	in	%	kg/m	lb/ft	
51,0	2"			3	45	9	135	102,0	4,02	90	0,900	0,61	
63,0	2 1/2"			3	45	9	135	126,0	4,96	90	1,470	0,99	
76,0	3"			3	45	9	135	152,0	5,98	90	1,830	1,23	
102,0	4"			2	30	6	90	204,0	8,03	90	2,980	2,01	
127,0	5"			2	30	6	90	254,0	10,00	90	4,200	2,83	
152,0	6"			2	30	6	90	304,0	11,97	90	5,150	3,47	

Dimensions shown may be changed without prior notice

// 780AA

**Bulk material S&D - PVC****Construction:** black antistatic synthetic elastomer.**Reinforcement:** black shock resistant thermoplastic elastomer.**Application:** bulk material suction and low pressure delivery-gravity feed. Specially designed for gravel, cement and iron ore transfer.**Constant operation:** -15 °C +60 °C (+5 °F +140 °F)

↔		↔		↙		↘		↵		%		⚖	
mm	in	mm	in	bar	psi	bar	psi	mm	in			kg/m	lb/ft
38,0	1 1/2"	47,00	1,85	2	30	8	120	80,0	3,15	100		0,570	0,39
51,0	2"	61,00	2,40	2	30	8	120	120,0	4,72	100		0,860	0,58
63,0	2 1/2"	75,00	2,95	2	30	8	120	200,0	7,87	100		1,090	0,74
76,0	3"	90,00	3,54	1	15	4	60	240,0	9,45	100		1,390	0,94
102,0	4"	119,00	4,69	1	15	4	60	320,0	12,60	100		2,560	1,73
127,0	5"	146,00	5,75	1	15	4	60	480,0	18,90	100		3,320	2,24
152,0	6"	175,00	6,89	1	15	4	60	720,0	28,35	100		4,890	3,29



// SANDBLAST



753AA	Sandblast 12 bar (180 psi) - Premium quality.....	91
753AH	Sandblast 12 bar (180 psi) - Premium quality.....	91
753AG	Sandblast 12 bar (180 psi) - Premium quality.....	92
755AA	Sandblast 12 bar (180 psi) - Top quality.....	92

Dimensions shown may be changed without prior notice

// 753AA



Sandblast 12 bar (180 psi) - Premium quality

Tube: black conductive NR - abrasion resistance 50 mm³ (ISO 4649/A).

Reinforcement: high tensile textile cords.

Cover: black SBR/NR - abrasion and ozone resistant - pin pricked.

Application: abrasive material blasting. Designed for long service life in heavy duty applications.

Constant operation: -40 °C +80 °C (-40 °F +176 °F)

↔		↔		↙	↘	↗		↖	↕	⚖		
mm	in	mm	in	bar	psi	bar	psi	mm	in	%	kg/m	lb/ft
13,0	1/2"	27,00	1,06	12	180	36	540				0,540	0,37
19,0	3/4"	33,00	1,30	12	180	36	540				0,700	0,48
19,0	3/4"	38,00	1,50	12	180	36	540				0,990	0,67
19,0	3/4"	40,00	1,57	12	180	36	540				1,150	0,78
25,0	1"	39,00	1,54	12	180	36	540				0,860	0,58
25,0	1"	48,00	1,89	12	180	36	540				1,520	1,03
32,0	1 1/4"	48,00	1,89	12	180	36	540				1,220	0,82
32,0	1 1/4"	55,00	2,17	12	180	36	540				1,810	1,22
38,0	1 1/2"	55,00	2,17	12	180	36	540				1,630	1,10
38,0	1 1/2"	60,00	2,36	12	180	36	540				2,050	1,38
51,0	2"	71,00	2,80	12	180	36	540				2,380	1,60
51,0	2"	73,00	2,87	12	180	36	540				2,640	1,78
51,0	2"	76,00	2,99	12	180	36	540				2,910	1,96

// 753AH



Sandblast 12 bar (180 psi) - Premium quality

Tube: black conductive NR - abrasion resistance 50 mm³ (ISO 4649/A).

Reinforcement: high tensile textile cords.

Cover: red SBR/EPDM - abrasion and ozone resistant - pin pricked.

Application: abrasive material blasting. Designed for long service life in heavy duty applications.

Constant operation: -40 °C +80 °C (-40 °F +176 °F)

↔		↔		↙	↘	↗		↖	↕	⚖		
mm	in	mm	in	bar	psi	bar	psi	mm	in	%	kg/m	lb/ft
19,0	3/4"	33,00	1,30	12	180	36	540				0,700	0,48
25,0	1"	39,00	1,54	12	180	36	540				0,860	0,58
32,0	1 1/4"	48,00	1,89	12	180	36	540				1,220	0,82
38,0	1 1/2"	55,00	2,17	12	180	36	540				1,630	1,10
51,0	2"	71,00	2,80	12	180	36	540				2,380	1,60

// 753AG



Sandblast 12 bar (180 psi) - Premium quality

Tube: black conductive NR - abrasion resistance 50 mm³ (ISO 4649/A).

Reinforcement: high tensile textile cords.

Cover: green SBR/EPDM - abrasion and ozone resistant - pin pricked.

Application: abrasive material blasting. Designed for long service life in heavy duty applications.

Constant operation: -40 °C +80 °C (-40 °F +176 °F)

↔		↔		↻		↻		⤴		⚖		
mm	in	mm	in	bar	psi	bar	psi	mm	in	%	kg/m	lb/ft
19,0	3/4"	38,00	1,50	12	180	36	540				0,970	0,66
25,0	1"	48,00	1,89	12	180	36	540				1,500	1,01
32,0	1 1/4"	55,00	2,17	12	180	36	540				1,790	1,21
38,0	1 1/2"	60,00	2,36	12	180	36	540				1,790	1,21

// 755AA



Sandblast 12 bar (180 psi) - Top quality

Tube: black conductive NR - abrasion resistance 36 mm³ (ISO 4649/A).

Reinforcement: high tensile textile cords.

Cover: black SBR/NR - abrasion and ozone resistant - pin pricked.

Application: abrasive material blasting. Designed for long service life in heavy duty application.

Constant operation: -40 °C +80 °C (-40 °F +176 °F)

↔		↔		↻		↻		⤴		⚖		
mm	in	mm	in	bar	psi	bar	psi	mm	in	%	kg/m	lb/ft
19,0	3/4"	33,00	1,30	12	180	36	540				0,740	0,50
25,0	1"	39,00	1,54	12	180	36	540				0,910	0,62
32,0	1 1/4"	48,00	1,89	12	180	36	540				1,280	0,87
38,0	1 1/2"	55,00	2,17	12	180	36	540				1,470	0,99
51,0	2"	71,00	2,80	12	180	36	540				2,430	1,64



// PLASTER

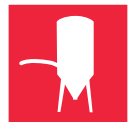

764OL	Plaster conveyance - Polyurethane.....	94
752AA	Plaster 10 bar (150 psi).....	94
757AA	Plaster 40 bar (600 psi).....	94
758AA	Plaster 55 bar (800 psi).....	95
758AE	Plaster 55 bar (800 psi).....	95

// 7640L



Plaster conveyance - Polyurethane

Construction: transparent polyurethane - abrasion and ozone resistant.

Reinforcement: white shock resistant rigid PVC.

Application: pneumatic conveyance of pre-mixed synthetic plaster from silo to plaster pumping machine. Assembly complete with fittings also available.

Constant operation: -20 °C +60 °C (-4 °F +140 °F)

↔		↔		↻		↻		⤴		⚖		
mm	in	mm	in	bar	psi	bar	psi	mm	in	%	kg/m	lb/ft
45,0	1 3/4"							203,0	7,99	60	0,680	0,46

// 752AA



Plaster 10 bar (150 psi)

Tube: black conductive NR - abrasion resistant.

Reinforcement: high tensile textile cords.

Cover: black SBR/NR - abrasion and ozone resistant - pin pricked.

Application: plaster and sand/cement mix pumping. Also suitable for heavy duty sandblast.

Constant operation: -30 °C +80 °C (-22 °F +176 °F)

↔		↔		↻		↻		⤴		⚖		
mm	in	mm	in	bar	psi	bar	psi	mm	in	%	kg/m	lb/ft
60,0	2 3/8"	80,00	3,15	10	150	30	450				2,310	1,56
65,0	2 9/16"	85,00	3,35	10	150	30	450				2,520	1,70
90,0	3 1/2"	113,00	4,45	10	150	30	450				4,110	2,77
102,0	4"	127,00	5,00	10	150	30	450				4,680	3,15

// 757AA



Plaster 40 bar (600 psi)

Tube: black conductive NR - abrasion resistant.

Reinforcement: high tensile textile cords.

Cover: black SBR/NR - abrasion and ozone resistant - pin pricked.

Application: plaster pumping.

Constant operation: -30 °C +80 °C (-22 °F +176 °F)

↔		↔		↻		↻		⤴		⚖		
mm	in	mm	in	bar	psi	bar	psi	mm	in	%	kg/m	lb/ft
25,0	1"	38,00	1,50	40	600	100	1500				0,700	0,48
32,0	1 1/4"	46,00	1,81	40	600	100	1500				0,870	0,59
35,0	1 3/8"	49,00	1,93	40	600	100	1500				0,960	0,65
38,0	1 1/2"	54,00	2,13	40	600	100	1500				1,190	0,80
51,0	2"	67,00	2,64	40	600	100	1500				1,600	1,08

Dimensions shown may be changed without prior notice

// 758AA

**Plaster 55 bar (800 psi)****Tube:** black conductive NR - abrasion resistant.**Reinforcement:** high tensile textile cords.**Cover:** black SBR/NR - abrasion and ozone resistant - pin pricked.**Application:** plaster pumping.**Constant operation:** -30 °C +80 °C (-22 °F +176 °F)

↔		↔		↻		↻		⤴		⚖		
mm	in	mm	in	bar	psi	bar	psi	mm	in	%	kg/m	lb/ft
25,0	1"	40,00	1,57	55	800	140	2000				0,870	0,59
32,0	1 1/4"	49,00	1,93	55	800	140	2000				1,250	0,85
38,0	1 1/2"	58,00	2,28	55	800	140	2000				1,710	1,15
51,0	2"	71,00	2,80	55	800	110	1600				2,220	1,50

// 758AE

**Plaster 55 bar (800 psi)****Tube:** black conductive NR - abrasion resistant.**Reinforcement:** high tensile textile cords.**Cover:** blue SBR/EPDM - abrasion and ozone resistant.**Application:** plaster pumping.**Constant operation:** -30 °C +80 °C (-22 °F +176 °F)

↔		↔		↻		↻		⤴		⚖		
mm	in	mm	in	bar	psi	bar	psi	mm	in	%	kg/m	lb/ft
25,0	1"	40,00	1,57	55	800	140	2000				0,940	0,64
32,0	1 1/4"	49,00	1,93	55	800	140	2000				1,450	0,98
38,0	1 1/2"	58,00	2,28	55	800	140	2000				1,990	1,34
51,0	2"	71,00	2,80	55	800	110	1600				2,570	1,73



// CONCRETE



754AA	Concrete vibrator 10 bar (150 psi).....	97
737AA	Concrete pumping 40 bar (600 psi).....	97
740AA	Concrete pumping 85 bar (1275 psi) - Heavy duty - Steel reinforced.....	98
741AA	Concrete pumping 100 bar (1500 psi) - Extra service - Steel reinforced.....	98

Dimensions shown may be changed without prior notice

// 754AA

**Concrete vibrator 10 bar (150 psi)****Tube:** black SBR.**Reinforcement:** high tensile textile cords.**Cover:** black SBR - abrasion and ozone resistant.**Application:** pneumatic concrete vibrators.**Constant operation:** -30 °C +80 °C (-22 °F +176 °F)

↔		↔		↙		↘		↵		⚖		
mm	in	mm	in	bar	psi	bar	psi	mm	in	%	kg/m	lb/ft
19,0	3/4"	31,00	1,22	10	150	40	600				0,690	0,47
25,0	1"	39,00	1,54	10	150	40	600				1,030	0,70

// 737AA

**Concrete pumping 40 bar (600 psi)****Tube:** black conductive NR - abrasion resistant.**Reinforcement:** high tensile textile cords.**Cover:** black conductive SBR/NR - abrasion and ozone resistant.**Application:** concrete pumping.**Constant operation:** -30 °C +80 °C (-22 °F +176 °F)

↔		↔		↙		↘		↵		⚖		
mm	in	mm	in	bar	psi	bar	psi	mm	in	%	kg/m	lb/ft
51,0	2"	69,00	2,72	40	600	100	1500				1,810	1,22
63,0	2 1/2"	83,00	3,27	40	600	100	1500				2,500	1,69
76,0	3"	104,00	4,09	40	600	100	1500				4,330	2,91
90,0	3 1/2"	118,00	4,65	40	600	100	1500				5,080	3,42
102,0	4"	130,00	5,12	40	600	100	1500				5,750	3,87

// 740AA



Concrete pumping 85 bar (1275 psi) - Heavy duty - Steel reinforced

Tube: black conductive NR - abrasion resistant.
Reinforcement: high tensile steel cords.
Cover: black conductive SBR/NR - abrasion and ozone resistant.
Application: high pressure concrete pumping.
Constant operation: -30 °C +80 °C (-22 °F +176 °F)

↔		↔		↕		↻		⤴		⚖		
mm	in	mm	in	bar	psi	bar	psi	mm	in	%	kg/m	lb/ft
51,0	2"	69,00	2,72	85	1275	170	2500	255,0	10,04		2,100	1,42
63,0	2 1/2"	85,00	3,35	85	1275	170	2500	315,0	12,40		3,300	2,22
76,0	3"	100,00	3,94	85	1275	170	2500	380,0	14,96		4,490	3,02
90,0	3 1/2"	116,00	4,57	85	1275	170	2500	450,0	17,72		5,430	3,65
102,0	4"	126,00	4,96	85	1275	170	2500	510,0	20,08		6,520	4,39
127,0	5"	153,00	6,02	85	1275	170	2500	635,0	25,00		9,720	6,54
152,0	6"	184,00	7,24	85	1275	170	2500	760,0	29,92		13,660	9,19

// 741AA



Concrete pumping 100 bar (1500 psi) - Extra service - Steel reinforced

Tube: black conductive NR - abrasion resistant.
Reinforcement: high tensile steel cords.
Cover: black conductive SBR/NR - abrasion and ozone resistant.
Application: high pressure concrete pumping. Designed for long service life in heavy duty applications.
Constant operation: -30 °C +80 °C (-22 °F +176 °F)

↔		↔		↕		↻		⤴		⚖		
mm	in	mm	in	bar	psi	bar	psi	mm	in	%	kg/m	lb/ft
51,0	2"	69,00	2,72	100	1500	200	2900	255,0	10,04		2,570	1,73
63,0	2 1/2"	85,00	3,35	100	1500	200	2900	315,0	12,40		3,750	2,53
76,0	3"	100,00	3,94	100	1500	200	2900	380,0	14,96		4,950	3,33
90,0	3 1/2"	116,00	4,57	100	1500	200	2900	450,0	17,72		7,190	4,84
102,0	4"	128,00	5,04	100	1500	200	2900	510,0	20,08		7,630	5,13
127,0	5"	155,00	6,10	100	1500	200	2900	635,0	25,00		10,220	6,87



// ACID CHEMICAL & MULTIPURPOSE



984AH	Multipurpose 20 bar (300 psi).....	100
974AH	Multipurpose 17 bar (250 psi) - Non conductive.....	100
975AH	Multipurpose 20 bar (300 psi) - Non conductive.....	101
954AH	Multipurpose 20 bar (300 psi) - Non conductive.....	101
976AB	General purpose 20 bar (300 psi) - EPDM.....	102
956AB	General purpose 20 bar (300 psi) - EPDM.....	102
503AA	Acid-chemical S&D 16 bar (240 psi) - EPDM.....	103
505OG	Acid-chemical S&D 16 bar (240 psi) - XLPE.....	103
529AA	Acid-chemical S&D 16 bar (240 psi) - UPE - EN 12115 - EU 10/2011 A+B+C+D2.....	104
509OE	Acid-chemical S&D 16 bar (240 psi) - UPE - FDA - EU 10/2011 A+B+C+D2.....	104
519OE	Acid-chemical S&D 16 bar (240 psi) - UPE - Corrugated - FDA - EU 10/2011 A+B+C+D2.....	105
538AA	Tank cleaning 20 bar (300 psi) - EPDM - Textile braided.....	105

// 984AH



Multipurpose 20 bar (300 psi)

Tube: black synthetic elastomer.

Reinforcement: high tensile textile cords.

Cover: red synthetic elastomer with longitudinal blue stripes - abrasion, ozone and hydrocarbon resistant.

Application: compressed air, water, fuel and oil delivery in general industrial applications.

Constant operation: -10 °C +60 °C (+14 °F +140 °F)

↔		↔		↻		↻		⤴		⚠	⚖	
mm	in	mm	in	bar	psi	bar	psi	mm	in	%	kg/m	lb/ft
6,0	1/4"	13,00	0,51	20	300	60	900	48,0	1,89		0,140	0,10
8,0	5/16"	15,00	0,59	20	300	60	900	64,0	2,52		0,170	0,12
10,0	3/8"	17,00	0,67	20	300	60	900	80,0	3,15		0,200	0,14
13,0	1/2"	21,00	0,83	20	300	60	900	104,0	4,09		0,275	0,19
16,0	5/8"	25,00	0,98	20	300	60	900	128,0	5,04		0,370	0,25
19,0	3/4"	29,00	1,14	20	300	60	900	152,0	5,98		0,500	0,34
25,0	1"	35,00	1,38	20	300	60	900	200,0	7,87		0,625	0,43

// 974AH



Multipurpose 17 bar (250 psi) - Non conductive

Tube: black non conductive NBR (RMA Class A).

Reinforcement: high tensile textile cords.

Cover: red NBR/PVC (RMA Class B) - abrasion, ozone and hydrocarbon resistant.

Application: premium quality compressed air, water, fuel and oil delivery in general industrial applications.

Constant operation: -25 °C +80 °C (-13 °F +176 °F)

↔		↔		↻		↻		⤴		⚠	⚖	
mm	in	mm	in	bar	psi	bar	psi	mm	in	%	kg/m	lb/ft
6,0	1/4"	13,00	0,51	17	250	68	986	38,0	1,50		0,120	0,09
10,0	3/8"	18,00	0,71	17	250	68	986	57,0	2,24		0,250	0,17
13,0	1/2"	21,00	0,83	17	250	68	986	76,0	2,99		0,360	0,25
16,0	5/8"	25,00	0,98	17	250	68	986	95,0	3,74		0,420	0,29
19,0	3/4"	29,00	1,14	17	250	68	986	114,0	4,49		0,540	0,37
25,0	1"	36,00	1,42	17	250	68	986	178,0	7,01		0,730	0,50

Dimensions shown may be changed without prior notice

// 975AH



Multipurpose 20 bar (300 psi) - Non conductive

Tube: black non conductive NBR (RMA Class A).

Reinforcement: high tensile textile cords.

Cover: red NBR/PVC (RMA Class A) - abrasion, ozone and hydrocarbon resistant.

Application: premium quality compressed air, water, fuel and oil delivery in general industrial applications.

Constant operation: -25 °C +80 °C (-13 °F +176 °F)

↔		↔		↙		↘		⤴		⚖		
mm	in	mm	in	bar	psi	bar	psi	mm	in	%	kg/m	lb/ft
6,0	1/4"	16,00	0,63	20	300	80	1200	38,0	1,50		0,240	0,17
10,0	3/8"	18,00	0,71	20	300	80	1200	57,0	2,24		0,270	0,19
13,0	1/2"	21,00	0,83	20	300	80	1200	76,0	2,99		0,370	0,25
19,0	3/4"	29,00	1,14	20	300	80	1200	114,0	4,49		0,620	0,42
25,0	1"	36,00	1,42	20	300	80	1200	178,0	7,01		0,940	0,64

// 954AH



Multipurpose 20 bar (300 psi) - Non conductive

Tube: black non conductive NBR.

Reinforcement: high tensile textile cords.

Cover: red NBR/PVC - abrasion, ozone and hydrocarbon resistant.

Application: premium quality compressed air, water, fuel and oil delivery in general industrial applications.

Constant operation: -30 °C +80 °C (-22 °F +176 °F)

↔		↔		↙		↘		⤴		⚖		
mm	in	mm	in	bar	psi	bar	psi	mm	in	%	kg/m	lb/ft
32,0	1 1/4"	44,00	1,73	20	300	60	900				1,050	0,71
38,0	1 1/2"	50,00	1,97	20	300	60	900				1,220	0,82
51,0	2"	65,00	2,56	20	300	60	900				1,610	1,09

// 976AB



General purpose 20 bar (300 psi) - EPDM

Tube: black conductive EPDM.

Reinforcement: high tensile textile cords.

Cover: grey EPDM - abrasion and ozone resistant.

Application: air, water and mild chemicals delivery in general industrial applications.

Constant operation: -40 °C +100 °C (-40 °F +212 °F)

↔		↔		↙		↘		↵		%	⚖	
mm	in	mm	in	bar	psi	bar	psi	mm	in		kg/m	lb/ft
6,0	1/4"	13,00	0,51	20	300	60	900	40,0	1,57		0,130	0,09
8,0	5/16"	15,00	0,59	20	300	60	900	50,0	1,97		0,160	0,11
10,0	3/8"	17,00	0,67	20	300	60	900	60,0	2,36		0,190	0,13
13,0	1/2"	21,00	0,83	20	300	60	900	75,0	2,95		0,270	0,19
16,0	5/8"	25,00	0,98	20	300	60	900	95,0	3,74		0,360	0,25
19,0	3/4"	29,00	1,14	20	300	60	900	100,0	3,94		0,460	0,31
25,0	1"	35,00	1,38	20	300	60	900	120,0	4,72		0,580	0,39

// 956AB



General purpose 20 bar (300 psi) - EPDM

Tube: black conductive EPDM.

Reinforcement: high tensile textile cords.

Cover: grey EPDM - abrasion and ozone resistant.

Application: air, water and mild chemicals delivery in general industrial applications.

Constant operation: -40 °C +100 °C (-40 °F +212 °F)

↔		↔		↙		↘		↵		%	⚖	
mm	in	mm	in	bar	psi	bar	psi	mm	in		kg/m	lb/ft
32,0	1 1/4"	44,00	1,73	20	300	60	900				0,920	0,62
38,0	1 1/2"	52,00	2,05	20	300	60	900				1,080	0,73
51,0	2"	66,00	2,60	20	300	60	900				1,650	1,11

Dimensions shown may be changed without prior notice

// 503AA



Acid-chemical S&D 16 bar (240 psi) - EPDM

Tube: black conductive EPDM.

Reinforcement: high tensile textile cords with embedded steel helix wire - antistatic wire.

Cover: black conductive EPDM - abrasion, ozone and fire resistant.

Application: acid and chemical suction and delivery.

Constant operation: -30 °C +100 °C (-22 °F +212 °F) depending on conveyed chemical

↔		↔		↻		↻		⤵		⚡	⚖	
mm	in	mm	in	bar	psi	bar	psi	mm	in	%	kg/m	lb/ft
19,0	3/4"	31,00	1,22	16	240	64	960	95,0	3,74	90	0,730	0,50
25,0	1"	37,00	1,46	16	240	64	960	125,0	4,92	90	0,900	0,61
32,0	1 1/4"	44,00	1,73	16	240	64	960	160,0	6,30	90	1,080	0,73
38,0	1 1/2"	51,00	2,01	16	240	64	960	190,0	7,48	90	1,240	0,84
50,0	2"	66,00	2,60	16	240	64	960	250,0	9,84	90	1,880	1,27
51,0	2"	67,00	2,64	16	240	64	960	250,0	9,84	90	1,910	1,29
63,0	2 1/2"	79,00	3,11	16	240	64	960	300,0	11,81	90	2,480	1,67
75,0	3"	91,00	3,58	16	240	64	960	350,0	13,78	80	2,960	1,99
76,0	3"	92,00	3,62	16	240	64	960	350,0	13,78	80	2,990	2,01
100,0	4"	116,00	4,57	16	240	64	960	450,0	17,72	80	3,970	2,67
102,0	4"	118,00	4,65	16	240	64	960	450,0	17,72	80	4,040	2,72

// 5050G



Acid-chemical S&D 16 bar (240 psi) - XLPE

Tube: transparent XLPE (Cross Linked Polyethylene).

Reinforcement: high tensile textile cords with embedded steel helix wire.

Cover: green EPDM - abrasion and ozone resistant.

Application: acid and chemical suction and delivery. Suitable for 90% of existing chemicals.

Constant operation: -30 °C +80 °C (-22 °F +176 °F)

↔		↔		↻		↻		⤵		⚡	⚖	
mm	in	mm	in	bar	psi	bar	psi	mm	in	%	kg/m	lb/ft
19,0	3/4"	31,00	1,22	16	240	48	720	114,0	4,49	90	0,670	0,46
25,0	1"	37,00	1,46	16	240	48	720	150,0	5,91	90	0,820	0,56
32,0	1 1/4"	44,00	1,73	16	240	48	720	192,0	7,56	90	0,980	0,66
38,0	1 1/2"	50,00	1,97	16	240	48	720	192,0	7,56	90	1,120	0,76
51,0	2"	63,00	2,48	16	240	48	720	300,0	11,81	90	1,480	1,00
63,0	2 1/2"	77,00	3,03	16	240	48	720	378,0	14,88	90	2,260	1,52
76,0	3"	92,00	3,62	16	240	48	720	450,0	17,72	80	2,710	1,83
102,0	4"	118,00	4,65	16	240	48	720	600,0	23,62	80	3,700	2,49

// 529AA



**Acid-chemical S&D 16 bar (240 psi) - UPE
EN 12115 - EU 10/2011 A+B+C+D2**

Tube: black conductive UPE (Ultra High Molecular Weight Polyethylene).

Reinforcement: high tensile textile cords with embedded steel helix wire - antistatic wire.

Cover: black conductive EPDM - abrasion, ozone and fire resistant.

Application: acid and chemical suction and delivery. Suitable for 98% of existing chemicals.

Constant operation: -30 °C +100 °C (-22 °F +212 °F) depending on conveyed chemical

↔		↔		↙		↘		↵		⌋		
mm	in	mm	in	bar	psi	bar	psi	mm	in	%	kg/m	lb/ft
19,0	3/4"	31,00	1,22	16	240	64	960	114,0	4,49	90	0,670	0,46
25,0	1"	37,00	1,46	16	240	64	960	150,0	5,91	90	0,830	0,56
32,0	1 1/4"	44,00	1,73	16	240	64	960	192,0	7,56	90	1,000	0,68
38,0	1 1/2"	51,00	2,01	16	240	64	960	228,0	8,98	90	1,300	0,88
50,0	2"	66,00	2,60	16	240	64	960	300,0	11,81	90	1,960	1,32
51,0	2"	67,00	2,64	16	240	64	960	300,0	11,81	90	1,990	1,34
75,0	3"	91,00	3,58	16	240	64	960	450,0	17,72	80	3,070	2,07
76,0	3"	92,00	3,62	16	240	64	960	450,0	17,72	80	3,110	2,10
100,0	4"	116,00	4,57	16	240	64	960	600,0	23,62	80	4,120	2,77
102,0	4"	118,00	4,65	16	240	64	960	600,0	23,62	80	4,190	2,82

// 5090E



**Acid-chemical S&D 16 bar (240 psi) - UPE
FDA - EU 10/2011 A+B+C+D2**

Tube: transparent UPE (Ultra High Molecular Weight Polyethylene).

Reinforcement: high tensile textile cords with embedded steel helix wire.

Cover: blue EPDM - abrasion and ozone resistant.

Application: acid and chemical suction and delivery. Suitable for 98% of existing chemicals.

Constant operation: -30 °C +100 °C (-22 °F +212 °F) depending on conveyed chemical

↔		↔		↙		↘		↵		⌋		
mm	in	mm	in	bar	psi	bar	psi	mm	in	%	kg/m	lb/ft
19,0	3/4"	31,00	1,22	16	240	48	720	114,0	4,49	90	0,590	0,40
25,0	1"	37,00	1,46	16	240	48	720	150,0	5,91	90	0,730	0,50
32,0	1 1/4"	44,00	1,73	16	240	48	720	192,0	7,56	90	0,880	0,60
38,0	1 1/2"	50,00	1,97	16	240	48	720	228,0	8,98	90	1,010	0,68
40,0	1 9/16"	52,00	2,05	16	240	48	720	240,0	9,45	90	1,050	0,71
51,0	2"	63,00	2,48	16	240	48	720	300,0	11,81	90	1,340	0,91
63,0	2 1/2"	77,00	3,03	16	240	48	720	378,0	14,88	90	2,090	1,41
76,0	3"	92,00	3,62	16	240	48	720	450,0	17,72	80	2,840	1,91
102,0	4"	118,00	4,65	16	240	48	720	600,0	23,62	80	3,870	2,61

Dimensions shown may be changed without prior notice

// 5190E



**Acid-chemical S&D 16 bar (240 psi) - UPE - Corrugated
FDA - EU 10/2011 A+B+C+D2**

Tube: transparent UPE (Ultra High Molecular Weight Polyethylene).

Reinforcement: high tensile textile cords with embedded steel helix wire.

Cover: blue EPDM - abrasion and ozone resistant.

Application: acid and chemical suction and delivery. Suitable for 98% of existing chemicals. Special construction for maximum flexibility.

Constant operation: -30 °C +100 °C (-22 °F +212 °F) depending on conveyed chemical

↔		↔		↙		↘		⤴		⚠		⚖	
mm	in	mm	in	bar	psi	bar	psi	mm	in	%	kg/m	lb/ft	
51,0	2"			16	240	48	720	150,0	5,91	90	1,390	0,94	
76,0	3"			16	240	48	720	228,0	8,98	90	2,510	1,69	
102,0	4"			16	240	48	720	300,0	11,81	90	4,100	2,76	

// 538AA



Tank cleaning 20 bar (300 psi) - EPDM - Textile braided

Tube: black conductive EPDM.

Reinforcement: high tensile textile braids - stainless steel antistatic wires.

Cover: black conductive EPDM - abrasion and ozone resistant.

Application: acid and chemical delivery in storage tanks cleaning applications.

Constant operation: -30 °C +100 °C (-22 °F +212 °F) depending on conveyed chemical

↔		↔		↙		↘		⤴		⚠		⚖	
mm	in	mm	in	bar	psi	bar	psi	mm	in	%	kg/m	lb/ft	
38,0	1 1/2"	54,00	2,13	20	300	60	900	304,0	11,97		1,330	0,90	
51,0	2"	67,00	2,64	20	300	60	900	408,0	16,06		1,840	1,24	





687AA	Automotive fuel 10 bar (150 psi) - DIN 73379/2A.....	108
689AA	Automotive fuel 10 bar (150 psi) - External textile braid.....	108
688AA	Diesel oil delivery 15 bar (225 psi) - External steel braid.....	108
680AA	Fuel-oil delivery 10 bar (150 psi).....	109
671AA	Fuel-oil delivery 16 bar (240 psi).....	109
650AA	Fuel-oil delivery 10 bar (150 psi).....	110
650AH	Fuel-oil delivery 10 bar (150 psi).....	110
650AB	Fuel-oil delivery 10 bar (150 psi).....	111
668EL	Fuel-oil S&D - PVC - Heavy duty.....	111
601AA	Oil rigger-fracking S&D 10 bar (150 psi).....	112
605AA	Fuel-oil S&D 10 bar (150 psi) - exceed SAE 100R4 - SAE J2006/R2 - ISO 13363/2/A+B.....	112
605AH	Fuel-oil S&D 10 bar (150 psi).....	113
629AA	Biofuel S&D 10 bar (150 psi).....	113
606AE	Tank truck 10 bar (150 psi) - Corrugated - Low temperature.....	113
655AA	Fuel-oil delivery 16 bar (240 psi) - exceeds EN 1761 - TRbF 131/2.....	114
619AA	Fuel-oil S&D 16 bar (240 psi) - EN 12115 - exceeds EN 1761 - TRbF 131/2.....	114
620AA	Fuel-oil S&D 20 bar (300 psi).....	115
658AA	Domestic fuel reeling 16 bar (240 psi) - Textile braided - EN 1360/1 - TRbF 131/2.....	115
659AA	LPG delivery 25 bar (375 psi) - Textile braided - EN 1762/DM.....	116
656AA	Aircraft ground fuelling 20 bar (300 psi).....	117
611AA	Aircraft ground fuelling-defuelling 20 bar (300 psi) - EN ISO 1825/F.....	117
614AA	Hot tar 10 bar (150 psi).....	118

// 687AA



**Automotive fuel 10 bar (150 psi)
DIN 73379/2A**

Tube: black NBR.
Reinforcement: high tensile textile cords.
Cover: black CR - abrasion, ozone and hydrocarbon resistant.
Application: petrol and diesel transfer in automotive applications. Also suitable for ecodiesel.
Constant operation: -35 °C +90 °C (-31 °F +194 °F)

↔		↔		↻		↻		⤴		⚠		⚖	
mm	in	mm	in	bar	psi	bar	psi	mm	in	%	kg/m	lb/ft	
3,5	9/64"	9,50	0,37	10	150	30	450	30,0	1,18		0,080	0,06	
5,0	3/16"	11,00	0,43	10	150	30	450	55,0	2,17		0,100	0,07	
5,5	7/32"	11,50	0,45	10	150	30	450	55,0	2,17		0,105	0,08	
6,0	1/4"	12,00	0,47	10	150	30	450	60,0	2,36		0,115	0,08	
7,5	19/64"	13,50	0,53	10	150	30	450	75,0	2,95		0,130	0,09	
9,5	3/8"	15,50	0,61	10	150	30	450	85,0	3,35		0,160	0,11	

// 689AA



Automotive fuel 10 bar (150 psi) - External textile braid

Tube: black NBR.
Reinforcement: high tensile textile braid.
Application: petrol and diesel transfer in automotive applications. Also suitable for unleaded fuel and ecodiesel.
Constant operation: -20 °C +100 °C (-4 °F +212 °F)

↔		↔		↻		↻		⤴		⚠		⚖	
mm	in	mm	in	bar	psi	bar	psi	mm	in	%	kg/m	lb/ft	
3,2	1/8"	7,00	0,28	10	150	30	450	25,0	0,98		0,040	0,03	
3,5	9/64"	7,50	0,30	10	150	30	450	28,0	1,10		0,045	0,04	
4,0	5/32"	8,00	0,31	10	150	30	450	35,0	1,38		0,050	0,04	
4,5	11/64"	9,50	0,37	10	150	30	450	38,0	1,50		0,060	0,05	
5,0	3/16"	10,00	0,39	10	150	30	450	40,0	1,57		0,065	0,05	
5,5	7/32"	10,50	0,41	10	150	30	450	45,0	1,77		0,070	0,05	
6,0	1/4"	11,00	0,43	10	150	30	450	50,0	1,97		0,075	0,06	
7,5	19/64"	12,50	0,49	10	150	30	450	60,0	2,36		0,085	0,06	
8,0	5/16"	13,00	0,51	10	150	30	450	65,0	2,56		0,090	0,07	
9,0	23/64"	14,00	0,55	10	150	30	450	75,0	2,95		0,105	0,08	
10,0	3/8"	15,00	0,59	10	150	30	450	80,0	3,15		0,110	0,08	
12,0	15/32"	17,00	0,67	8	120	24	350	90,0	3,54		0,135	0,10	

// 688AA



Diesel oil delivery 15 bar (225 psi) - External steel braid

Tube: black NBR.
Reinforcement: plated steel braid.
Application: diesel oil delivery. Specially designed for burner feed line.
Constant operation: -20 °C +100 °C (-4 °F +212 °F)

↔		↔		↻		↻		⤴		⚠		⚖	
mm	in	mm	in	bar	psi	bar	psi	mm	in	%	kg/m	lb/ft	
6,0	1/4"	11,00	0,43	15	225	70	1000	30,0	1,18		0,100	0,07	
8,0	5/16"	13,00	0,51	15	225	70	1000	40,0	1,57		0,155	0,11	
10,0	3/8"	15,00	0,59	15	225	70	1000	45,0	1,77		0,190	0,13	
12,0	15/32"	17,00	0,67	15	225	70	1000	55,0	2,17		0,230	0,16	

Dimensions shown may be changed without prior notice

// 680AA



Fuel-oil delivery 10 bar (150 psi)

Tube: black synthetic elastomer.

Reinforcement: high tensile textile cords - antistatic wire ID ≥ 13 mm.

Cover: black synthetic elastomer - abrasion, ozone and hydrocarbon resistant.

Application: general purpose fuel and oil delivery.

Constant operation: -10 °C +60 °C (+14 °F +140 °F)

↔		↔		↙		↘		⤴		⤵		
mm	in	mm	in	bar	psi	bar	psi	mm	in	%	kg/m	lb/ft
6,0	1/4"	13,00	0,51	10	150	30	450	48,0	1,89		0,140	0,10
8,0	5/16"	15,00	0,59	10	150	30	450	64,0	2,52		0,170	0,12
10,0	3/8"	17,00	0,67	10	150	30	450	80,0	3,15		0,200	0,14
13,0	1/2"	20,00	0,79	10	150	30	450	104,0	4,09		0,245	0,17
19,0	3/4"	27,00	1,06	10	150	30	450	152,0	5,98		0,395	0,27
25,0	1"	35,00	1,38	10	150	30	450	200,0	7,87		0,625	0,43

// 671AA



Fuel-oil delivery 16 bar (240 psi)

Tube: black conductive NBR.

Reinforcement: high tensile textile cords.

Cover: black synthetic rubber - abrasion, ozone and hydrocarbon resistant.

Application: general purpose fuel and oil delivery.

Constant operation: -25 °C +80 °C (-13 °F +176 °F)

↔		↔		↙		↘		⤴		⤵		
mm	in	mm	in	bar	psi	bar	psi	mm	in	%	kg/m	lb/ft
5,0	3/16"	12,00	0,47	16	240	48	720	50,0	1,97		0,130	0,09
6,0	1/4"	13,00	0,51	16	240	48	720	60,0	2,36		0,140	0,10
7,0	9/32"	13,00	0,51	16	240	48	720	70,0	2,76		0,135	0,10
8,0	5/16"	15,00	0,59	16	240	48	720	80,0	3,15		0,170	0,12
10,0	3/8"	17,00	0,67	16	240	48	720	100,0	3,94		0,200	0,14
13,0	1/2"	20,00	0,79	16	240	48	720	130,0	5,12		0,250	0,17
16,0	5/8"	24,00	0,94	16	240	48	720	160,0	6,30		0,350	0,24
19,0	3/4"	27,00	1,06	16	240	48	720	190,0	7,48		0,400	0,27
25,0	1"	35,00	1,38	16	240	48	720	250,0	9,84		0,680	0,46

// 650AA



Fuel-oil delivery 10 bar (150 psi)

Tube: black conductive NBR.
Reinforcement: high tensile textile cords.
Cover: black conductive CR - abrasion, ozone, hydrocarbon and fire resistant.
Application: general purpose fuel and oil delivery.
Constant operation: -30 °C +80 °C (-22 °F +176 °F)

↔		↔		↙		↘		↵		↗	⚖	
mm	in	mm	in	bar	psi	bar	psi	mm	in	%	kg/m	lb/ft
19,0	3/4"	29,00	1,14	10	150	30	450				0,450	0,31
25,0	1"	35,00	1,38	10	150	30	450				0,570	0,39
32,0	1 1/4"	42,00	1,65	10	150	30	450				0,700	0,48
32,0	1 1/4"	44,00	1,73	10	150	30	450				0,860	0,58
35,0	1 3/8"	47,00	1,85	10	150	30	450				0,940	0,64
38,0	1 1/2"	48,00	1,89	10	150	30	450				0,820	0,56
38,0	1 1/2"	50,00	1,97	10	150	30	450				1,000	0,68
40,0	1 9/16"	52,00	2,05	10	150	30	450				1,050	0,71
45,0	1 3/4"	57,00	2,24	10	150	30	450				1,170	0,79
51,0	2"	61,00	2,40	10	150	30	450				1,090	0,74
51,0	2"	63,00	2,48	10	150	30	450				1,320	0,89
63,0	2 1/2"	75,00	2,95	10	150	30	450				1,600	1,08
76,0	3"	88,00	3,46	10	150	30	450				1,930	1,30
102,0	4"	114,00	4,49	10	150	30	450				2,610	1,76

// 650AH



Fuel-oil delivery 10 bar (150 psi)

Tube: black conductive NBR.
Reinforcement: high tensile textile cords - antistatic wire.
Cover: red CR - abrasion, ozone and hydrocarbon resistant.
Application: general purpose fuel and oil delivery.
Constant operation: -30 °C +80 °C (-22 °F +176 °F)

↔		↔		↙		↘		↵		↗	⚖	
mm	in	mm	in	bar	psi	bar	psi	mm	in	%	kg/m	lb/ft
19,0	3/4"	29,00	1,14	10	150	30	450				0,510	0,35
22,0	7/8"	32,00	1,26	10	150	30	450				0,570	0,39
25,0	1"	35,00	1,38	10	150	30	450				0,640	0,44
32,0	1 1/4"	44,00	1,73	10	150	30	450				0,950	0,64
38,0	1 1/2"	48,00	1,89	10	150	30	450				0,910	0,62
38,0	1 1/2"	50,00	1,97	10	150	30	450				1,100	0,74
51,0	2"	61,00	2,40	10	150	30	450				1,200	0,81
51,0	2"	63,00	2,48	10	150	30	450				1,440	0,97
63,0	2 1/2"	77,00	3,03	10	150	30	450				2,060	1,39
76,0	3"	88,00	3,46	10	150	30	450				2,090	1,41
76,0	3"	92,00	3,62	10	150	30	450				2,530	1,71
102,0	4"	114,00	4,49	10	150	30	450				2,830	1,91

Dimensions shown may be changed without prior notice

// 650AB



Fuel-oil delivery 10 bar (150 psi)

Tube: black conductive NBR.
Reinforcement: high tensile textile cords - antistatic wire.
Cover: grey CR - abrasion, ozone and hydrocarbon resistant.
Application: general purpose fuel and oil delivery.
Constant operation: -30 °C +80 °C (-22 °F +176 °F)

↔		↔		↙		↘		↗		⚖		
mm	in	mm	in	bar	psi	bar	psi	mm	in	%	kg/m	lb/ft
25,0	1"	35,00	1,38	10	150	30	450				0,640	0,44
32,0	1 1/4"	42,00	1,65	10	150	30	450				0,780	0,53
32,0	1 1/4"	44,00	1,73	10	150	30	450				0,940	0,64
38,0	1 1/2"	48,00	1,89	10	150	30	450				0,910	0,62
38,0	1 1/2"	50,00	1,97	10	150	30	450				1,100	0,74

// 668EL



Fuel-oil S&D - PVC - Heavy duty

Construction: blue PVC - abrasion, ozone and hydrocarbon resistant.
Reinforcement: white shock resistant rigid PVC.
Application: general purpose fuel and oil suction and delivery.
Constant operation: -10 °C +60 °C (+14 °F +140 °F)

↔		↔		↙		↘		↗		⚖		
mm	in	mm	in	bar	psi	bar	psi	mm	in	%	kg/m	lb/ft
25,0	1"			7	100	21	300	150,0	5,91	90	0,540	0,37
32,0	1 1/4"			6	90	18	270	192,0	7,56	90	0,680	0,46
38,0	1 1/2"			6	90	18	270	228,0	8,98	90	0,760	0,52
40,0	1 9/16"			6	90	18	270	240,0	9,45	90	0,800	0,54
51,0	2"			5	75	15	225	306,0	12,05	90	1,150	0,78
60,0	2 3/8"			4	60	12	180	360,0	14,17	90	1,550	1,05
63,0	2 1/2"			4	60	12	180	378,0	14,88	90	1,600	1,08
76,0	3"			4	60	12	180	456,0	17,95	90	2,000	1,35
80,0	3 1/8"			4	60	12	180	480,0	18,90	90	2,100	1,42
102,0	4"			3	45	9	135	612,0	24,09	90	3,100	2,09

// 601AA



Oil rigger-fracking S&D 10 bar (150 psi)

Tube: black NBR/PVC.

Reinforcement: high tensile textile cords with embedded steel helix wire.

Cover: black SBR - abrasion and ozone resistant.

Application: crude oil mud in oilfield vacuum tank service. Extensively used in fracking operations.

Constant operation: -30 °C +80 °C (-22 °F +176 °F)

↔		↔		↙		↘		⤴		⚖		
mm	in	mm	in	bar	psi	bar	psi	mm	in	%	kg/m	lb/ft
51,0	2"	62,00	2,44	10	150	30	450	255,0	10,04	100	1,370	0,93
76,0	3"	89,00	3,50	10	150	30	450	380,0	14,96	90	2,540	1,71
102,0	4"	116,00	4,57	10	150	30	450	510,0	20,08	90	3,990	2,69
152,0	6"	168,00	6,61	10	150	25	375	760,0	29,92	80	6,760	4,55

// 605AA



**Fuel-oil S&D 10 bar (150 psi)
exceed SAE 100R4 - SAE J2006/R2 - ISO
13363/2/A+B**

Tube: black conductive NBR.

Reinforcement: high tensile textile cords with embedded steel helix wire.

Cover: black CR - abrasion, ozone and hydrocarbon resistant.

Application: fuel and oil suction and delivery. Specially designed for tank truck and general industrial applications. Also suitable for marine wet exhaust and bilge pump connection.

Constant operation: -30 °C +80 °C (-22 °F +176 °F)

↔		↔		↙		↘		⤴		⚖		
mm	in	mm	in	bar	psi	bar	psi	mm	in	%	kg/m	lb/ft
19,0	3/4"	30,00	1,18	10	150	30	450	76,0	2,99	100	0,590	0,40
25,0	1"	36,00	1,42	10	150	30	450	100,0	3,94	100	0,750	0,51
30,0	1 3/16"	41,00	1,61	10	150	30	450	120,0	4,72	100	0,890	0,60
32,0	1 1/4"	43,00	1,69	10	150	30	450	128,0	5,04	100	0,940	0,64
35,0	1 3/8"	46,00	1,81	10	150	30	450	140,0	5,51	100	1,020	0,69
38,0	1 1/2"	49,00	1,93	10	150	30	450	152,0	5,98	100	1,020	0,69
40,0	1 9/16"	51,00	2,01	10	150	30	450	160,0	6,30	100	1,140	0,77
42,0	1 5/8"	53,00	2,09	10	150	30	450	168,0	6,61	100	1,190	0,80
45,0	1 3/4"	56,00	2,20	10	150	30	450	180,0	7,09	100	1,260	0,85
48,0	1 7/8"	59,00	2,32	10	150	30	450	192,0	7,56	100	1,330	0,90
51,0	2"	62,00	2,44	10	150	30	450	204,0	8,03	100	1,410	0,95
57,0	2 1/4"	68,00	2,68	10	150	30	450	228,0	8,98	100	1,570	1,06
60,0	2 3/8"	73,00	2,87	10	150	30	450	240,0	9,45	100	1,980	1,34
63,0	2 1/2"	76,00	2,99	10	150	30	450	252,0	9,92	90	2,060	1,39
70,0	2 3/4"	83,00	3,27	10	150	30	450	280,0	11,02	90	2,300	1,55
76,0	3"	89,00	3,50	10	150	30	450	304,0	11,97	90	2,470	1,66
80,0	3 1/8"	94,00	3,70	10	150	30	450	320,0	12,60	90	2,650	1,79
90,0	3 1/2"	104,00	4,09	10	150	30	450	360,0	14,17	90	3,090	2,08
102,0	4"	116,00	4,57	10	150	30	450	408,0	16,06	90	3,440	2,32
110,0	4 5/16"	124,00	4,88	10	150	30	450	440,0	17,32	90	4,150	2,79
115,0	4 1/2"	129,00	5,08	10	150	30	450	460,0	18,11	90	4,320	2,91
120,0	4 3/4"	138,00	5,43	10	150	30	450	480,0	18,90	80	5,530	3,72
127,0	5"	145,00	5,71	10	150	30	450	508,0	20,00	80	5,810	3,91
133,0	5 1/4"	151,00	5,94	10	150	30	450	532,0	20,94	80	6,050	4,07
152,0	6"	170,00	6,69	10	150	25	375	608,0	23,94	80	7,230	4,86
203,0	8"	225,00	8,86	10	150	25	375	812,0	31,97	70	11,470	7,71

Dimensions shown may be changed without prior notice

// 605AH



Fuel-oil S&D 10 bar (150 psi)

Tube: black conductive NBR.
Reinforcement: high tensile textile cords with embedded steel helix wire.
Cover: red CR - abrasion, ozone and hydrocarbon resistant.
Application: fuel and oil suction and delivery. Specially designed for tank truck and general industrial applications.
Constant operation: -30 °C +80 °C (-22 °F +176 °F)

↔		↔		↕		↕		⤴		⚖		
mm	in	mm	in	bar	psi	bar	psi	mm	in	%	kg/m	lb/ft
38,0	1 1/2"	49,00	1,93	10	150	30	450	152,0	5,98	100	1,070	0,72
51,0	2"	62,00	2,44	10	150	30	450	204,0	8,03	100	1,380	0,93
76,0	3"	89,00	3,50	10	150	30	450	304,0	11,97	90	2,225	1,50
102,0	4"	116,00	4,57	10	150	30	450	408,0	16,06	90	3,540	2,38

// 629AA



Biofuel S&D 10 bar (150 psi)

Tube: black conductive NBR.
Reinforcement: high tensile textile cords with embedded steel helix wire.
Cover: black CR - abrasion, ozone and hydrocarbon resistant.
Application: fuel and oil suction and delivery. Specially designed for biofuel and ethanol.
Constant operation: -30 °C +80 °C (-22 °F +176 °F)

↔		↔		↕		↕		⤴		⚖		
mm	in	mm	in	bar	psi	bar	psi	mm	in	%	kg/m	lb/ft
19,0	3/4"	30,00	1,18	10	150	30	450	76,0	2,99	100	0,620	0,42
25,0	1"	36,00	1,42	10	150	30	450	100,0	3,94	100	0,770	0,52
32,0	1 1/4"	43,00	1,69	10	150	30	450	128,0	5,04	100	0,970	0,66
38,0	1 1/2"	49,00	1,93	10	150	30	450	152,0	5,98	100	1,200	0,81
51,0	2"	62,00	2,44	10	150	30	450	204,0	8,03	100	1,450	0,98
76,0	3"	89,00	3,50	10	150	30	450	304,0	11,97	90	2,540	1,71
102,0	4"	116,00	4,57	10	150	30	450	408,0	16,06	90	3,540	2,38

// 606AE



Tank truck 10 bar (150 psi) - Corrugated - Low temperature

Tube: black conductive NBR.
Reinforcement: high tensile textile cords with embedded steel helix wire.
Cover: blue CR - abrasion, ozone and hydrocarbon resistant.
Application: fuel, oil and hydraulic fluids suction and delivery. Specially designed for tank truck applications where extreme flexibility at low temperatures is required.
Constant operation: -54 °C +82 °C (-65 °F +180 °F)

↔		↔		↕		↕		⤴		⚖		
mm	in	mm	in	bar	psi	bar	psi	mm	in	%	kg/m	lb/ft
51,0	2"			10	150	30	450	76,0	2,99	100	1,540	1,04
76,0	3"			10	150	30	450	114,0	4,49	100	2,680	1,81
102,0	4"			10	150	30	450	153,0	6,02	100	3,910	2,63

// 655AA



**Fuel-oil delivery 16 bar (240 psi)
exceeds EN 1761 - TRbF 131/2**

Tube: black conductive NBR.

Reinforcement: high tensile textile cords.

Cover: black conductive CR - abrasion, ozone, hydrocarbon and fire resistant.

Application: fuel and oil delivery. Designed for long service life in heavy duty applications.

Constant operation: -30 °C +70 °C (-22 °F +158 °F)

↔		↔		↙		↘		⤴		⌘	⚖	
mm	in	mm	in	bar	psi	bar	psi	mm	in	%	kg/m	lb/ft
19,0	3/4"	31,00	1,22	16	240	48	720	125,0	4,92		0,560	0,38
25,0	1"	37,00	1,46	16	240	48	720	150,0	5,91		0,690	0,47
32,0	1 1/4"	44,00	1,73	16	240	48	720	175,0	6,89		0,870	0,59
38,0	1 1/2"	51,00	2,01	16	240	48	720	225,0	8,86		1,020	0,69
51,0	2"	67,00	2,64	16	240	48	720	275,0	10,83		1,550	1,05
63,0	2 1/2"	79,00	3,11	16	240	48	720	300,0	11,81		1,880	1,27
76,0	3"	92,00	3,62	16	240	48	720	350,0	13,78		2,310	1,56
102,0	4"	118,00	4,65	16	240	48	720	450,0	17,72		3,410	2,30
152,0	6"	170,00	6,69	16	240	48	720	750,0	29,53		5,140	3,46

// 619AA



**Fuel-oil S&D 16 bar (240 psi)
EN 12115 - exceeds EN 1761 - TRbF 131/2**

Tube: black conductive NBR.

Reinforcement: high tensile textile cords with embedded steel helix wire - antistatic wire.

Cover: black conductive CR - abrasion, ozone, hydrocarbon and fire resistant.

Application: fuel and oil suction and delivery. Designed for long service life in heavy duty applications.

Constant operation: -30 °C +70 °C (-22 °F +158 °F)

↔		↔		↙		↘		⤴		⌘	⚖	
mm	in	mm	in	bar	psi	bar	psi	mm	in	%	kg/m	lb/ft
19,0	3/4"	31,00	1,22	16	240	64	960	95,0	3,74	100	0,690	0,47
25,0	1"	37,00	1,46	16	240	64	960	150,0	5,91	100	0,850	0,58
32,0	1 1/4"	44,00	1,73	16	240	64	960	175,0	6,89	100	1,030	0,70
38,0	1 1/2"	51,00	2,01	16	240	64	960	225,0	8,86	100	1,180	0,80
50,0	2"	66,00	2,60	16	240	64	960	275,0	10,83	100	1,760	1,19
51,0	2"	67,00	2,64	16	240	64	960	275,0	10,83	100	2,010	1,36
63,0	2 1/2"	79,00	3,11	16	240	64	960	300,0	11,81	90	2,590	1,75
75,0	3"	91,00	3,58	16	240	64	960	350,0	13,78	90	2,790	1,88
76,0	3"	92,00	3,62	16	240	64	960	350,0	13,78	90	2,820	1,90
100,0	4"	116,00	4,57	16	240	64	960	450,0	17,72	90	3,760	2,53
102,0	4"	118,00	4,65	16	240	64	960	450,0	17,72	90	3,820	2,57

Dimensions shown may be changed without prior notice

// 620AA



Fuel-oil S&D 20 bar (300 psi)

Tube: black conductive NBR.
Reinforcement: high tensile textile cords with embedded steel helix wire - antistatic wire.
Cover: black CR - abrasion, ozone and hydrocarbon resistant.
Application: fuel and oil suction and delivery. Designed for long service life in heavy duty applications.
Constant operation: -30 °C +80 °C (-22 °F +176 °F)

↔		↔		↻		↻		⤴		⚡	⚖	
mm	in	mm	in	bar	psi	bar	psi	mm	in	%	kg/m	lb/ft
51,0	2"	63,00	2,48	20	300	60	900	204,0	8,03	100	1,650	1,11
63,0	2 1/2"	77,00	3,03	20	300	60	900	252,0	9,92	90	2,140	1,44
76,0	3"	90,00	3,54	20	300	60	900	304,0	11,97	90	2,620	1,77
102,0	4"	116,00	4,57	20	300	60	900	408,0	16,06	90	3,580	2,41
127,0	5"	145,00	5,71	20	300	60	900	508,0	20,00	80	6,090	4,10
152,0	6"	170,00	6,69	20	300	60	900	608,0	23,94	80	8,250	5,55
203,0	8"	225,00	8,86	20	300	60	900	812,0	31,97	70	12,310	8,28

// 658AA



**Domestic fuel reeling 16 bar (240 psi) - Textile braided
 EN 1360/1 - TRbF 131/2**

Tube: black conductive NBR.
Reinforcement: high tensile textile braids.
Cover: black conductive CR - abrasion, ozone, hydrocarbon and fire resistant.
Application: fuel and oil delivery in heavy duty reeling applications. Also suitable for tank cleaning. Antistatic wire available on request.
Constant operation: -30 °C +70 °C (-22 °F +158 °F)

↔		↔		↻		↻		⤴		⚡	⚖	
mm	in	mm	in	bar	psi	bar	psi	mm	in	%	kg/m	lb/ft
25,0	1"	37,00	1,46	16	240	48	720	125,0	4,92		0,660	0,45
32,0	1 1/4"	44,00	1,73	16	240	48	720	160,0	6,30		0,790	0,54
35,0	1 3/8"	47,00	1,85	16	240	48	720	175,0	6,89		0,850	0,58
38,0	1 1/2"	51,00	2,01	16	240	48	720	190,0	7,48		1,030	0,70
51,0	2"	67,00	2,64	16	240	48	720	255,0	10,04		1,720	1,16

// 659AA



LPG delivery 25 bar (375 psi) - Textile braided EN 1762/DM

Tube: black NBR.

Reinforcement: high tensile textile braids - antistatic wire.

Cover: black CR - abrasion, ozone, hydrocarbon and fire resistant - pin pricked.

Application: LPG delivery in heavy duty reeling applications.

Constant operation: -30 °C +70 °C (-22 °F +158 °F)

↔		↔		↙		↘		⤴		⤵	⬆	
mm	in	mm	in	bar	psi	bar	psi	mm	in	%	kg/m	lb/ft
19,0	3/4"	31,00	1,22	25	375	100	1500	160,0	6,30		0,690	0,47
25,0	1"	38,00	1,50	25	375	100	1500	200,0	7,87		0,860	0,58
32,0	1 1/4"	45,00	1,77	25	375	100	1500	250,0	9,84		1,130	0,76
38,0	1 1/2"	52,00	2,05	25	375	100	1500	320,0	12,60		1,440	0,97
51,0	2"	67,00	2,64	25	375	100	1500	400,0	15,75		2,220	1,50

Dimensions shown may be changed without prior notice

// 656AA



Aircraft ground fuelling 20 bar (300 psi)

Tube: black NBR.

Reinforcement: high tensile textile braids.

Cover: black conductive CR - abrasion, ozone and hydrocarbon resistant.

Application: aircraft ground fuelling.

Constant operation: -30 °C +65 °C (-22 °F +150 °F)

↔		↔		↻		↻		⤴		⚖		
mm	in	mm	in	bar	psi	bar	psi	mm	in	%	kg/m	lb/ft
25,0	1"	37,00	1,46	20	300	80	1200	150,0	5,91		0,770	0,52
32,0	1 1/4"	44,00	1,73	20	300	80	1200	190,0	7,48		0,920	0,62
38,0	1 1/2"	51,00	2,01	20	300	80	1200	225,0	8,86		1,180	0,80
50,0	2"	66,00	2,60	20	300	80	1200	275,0	10,83		1,810	1,22
63,0	2 1/2"	79,00	3,11	20	300	80	1200	300,0	11,81		2,070	1,40
75,0	3"	91,00	3,58	20	300	80	1200	300,0	11,81		2,500	1,69
100,0	4"	120,00	4,72	20	300	80	1200	450,0	17,72		3,690	2,48

// 611AA



Aircraft ground fuelling-defuelling 20 bar (300 psi)

EN ISO 1825/F

Tube: black NBR.

Reinforcement: high tensile textile cords with embedded nylon helix.

Cover: black conductive CR - abrasion, ozone and hydrocarbon resistant.

Application: aircraft ground fuelling and defuelling.

Constant operation: -30 °C +65 °C (-22 °F +150 °F)

↔		↔		↻		↻		⤴		⚖		
mm	in	mm	in	bar	psi	bar	psi	mm	in	%	kg/m	lb/ft
25,0	1"	41,00	1,61	20	300	80	1200	150,0	5,91	65	0,850	0,58
32,0	1 1/4"	48,00	1,89	20	300	80	1200	190,0	7,48	65	1,060	0,72
38,0	1 1/2"	54,00	2,13	20	300	80	1200	225,0	8,86	65	1,230	0,83
50,0	2"	67,00	2,64	20	300	80	1200	275,0	10,83	65	1,860	1,26
63,0	2 1/2"	81,00	3,19	20	300	80	1200	300,0	11,81	65	2,390	1,61
75,0	3"	93,00	3,66	20	300	80	1200	300,0	11,81	65	2,850	1,92

// 614AA

**Hot tar 10 bar (150 psi)****Tube:** black NBR.**Reinforcement:** high tensile textile cords with embedded steel helix wire.**Cover:** black CSM - abrasion and ozone resistant.**Application:** hot tar, asphalt and bitumen suction and delivery.**Constant operation:** -20 °C +180 °C (-4 °F +356 °F)

↔		↔		↻		↻		⤴		⤵		⚖	
mm	in	mm	in	bar	psi	bar	psi	mm	in	%	kg/m	lb/ft	
51,0	2"	69,00	2,72	10	150	40	600	255,0	10,04	100	2,280	1,54	
76,0	3"	96,00	3,78	10	150	40	600	380,0	14,96	90	3,780	2,55	
102,0	4"	122,00	4,80	10	150	40	600	510,0	20,08	90	5,040	3,39	



// MARINE



266LL	Marine sanitary hose - PVC.....	120
202LL	Marine sanitary hose 7 bar (100 psi).....	120
653AA	Marine exhaust - Soft wall.....	121
6E1AA	Marine exhaust - Hard wall - SAE J2006/R2 - ISO 13363/2/A+B.....	122
605AA	Fuel-oil S&D 10 bar (150 psi) - exceed SAE 100R4 - SAE J2006/R2 - ISO 13363/2/A+B.....	123

// 266LL



Marine sanitary hose - PVC

Construction: white thermoplastic elastomer.
Reinforcement: white shock resistant rigid PVC.
Application: sanitary hose for marine installations.
Constant operation: -5 °C +60 °C (+23 °F +140 °F)

↔		↔		↙		↘		↵		⚖		
mm	in	mm	in	bar	psi	bar	psi	mm	in	%	kg/m	lb/ft
19,0	3/4"			8	120	24	350	75,0	2,95	70	0,300	0,21
25,0	1"			8	120	24	350	120,0	4,72	70	0,380	0,26
38,0	1 1/2"			6	90	18	270	170,0	6,69	70	0,580	0,39

// 202LL



Marine sanitary hose 7 bar (100 psi) ISO 8099

Tube: white chlorobutyl - impermeable and odourless.
Reinforcement: high tensile textile cords with embedded steel helix wire.
Cover: white NBR/PVC - abrasion, ozone and hydrocarbon resistant.
Application: sanitary hose for marine installations. Designed for excellent kink resistance at tight bend radius and maximum flexibility. Top permeability resistance.
Constant operation: -30 °C +80 °C (-22 °F +176 °F)

↔		↔		↙		↘		↵		⚖		
mm	in	mm	in	bar	psi	bar	psi	mm	in	%	kg/m	lb/ft
19,0	3/4"	29,00	1,14	7	100	21	300	38,0	1,50	100	0,670	0,46
25,0	1"	35,00	1,38	7	100	21	300	50,0	1,97	100	0,840	0,57
38,0	1 1/2"	48,00	1,89	7	100	21	300	76,0	2,99	100	1,260	0,85
51,0	2"	61,00	2,40	7	100	21	300	102,0	4,02	100	1,640	1,11

Dimensions shown may be changed without prior notice

// 653AA



LLOYD'S

Marine exhaust - Soft wall
SAE J2006/R1 - ISO 13363/1/A+B
Tube: black synthetic rubber.**Reinforcement:** high tensile textile cords.**Cover:** black synthetic rubber - abrasion and ozone resistant.**Application:** marine wet exhaust. Also suitable for bilge pump connection.**Constant operation:** -30 °C +100 °C (-22 °F +212 °F)

↔		↔		↕		↕		↗		↗	⚖	
mm	in	mm	in	bar	psi	bar	psi	mm	in	%	kg/m	lb/ft
25,0	1"	35,00	1,38	3	45	15	225				0,630	0,43
28,0	1 1/8"	38,00	1,50	3	45	15	225				0,700	0,48
32,0	1 1/4"	42,00	1,65	3	45	15	225				0,780	0,53
35,0	1 3/8"	45,00	1,77	3	45	15	225				0,840	0,57
38,0	1 1/2"	48,00	1,89	3	45	15	225				0,910	0,62
42,0	1 5/8"	52,00	2,05	3	45	15	225				0,990	0,67
45,0	1 3/4"	55,00	2,17	3	45	15	225				1,050	0,71
48,0	1 7/8"	58,00	2,28	3	45	15	225				1,120	0,76
51,0	2"	63,00	2,48	3	45	15	225				1,440	0,97
57,0	2 1/4"	69,00	2,72	3	45	15	225				1,590	1,07
60,0	2 3/8"	74,00	2,91	3	45	15	225				1,960	1,32
63,0	2 1/2"	77,00	3,03	3	45	15	225				2,050	1,38
76,0	3"	90,00	3,54	3	45	15	225				2,460	1,66
90,0	3 1/2"	104,00	4,09	3	45	15	225				2,920	1,97
102,0	4"	116,00	4,57	3	45	15	225				3,270	2,20
115,0	4 1/2"	129,00	5,08	3	45	15	225				3,650	2,46
127,0	5"	141,00	5,55	3	45	15	225				4,030	2,71
152,0	6"	168,00	6,61	3	45	15	225				4,900	3,30
168,0	6 5/8"	184,00	7,24	3	45	15	225				5,370	3,61
203,0	8"	221,00	8,70	3	45	15	225				7,460	5,02

// 6E1AA



Marine exhaust - Hard wall
SAE J2006/R2 - ISO 13363/2/A+B

Tube: black synthetic rubber - oil resistant.
Reinforcement: high tensile textile cords with embedded steel helix wire.
Cover: black synthetic rubber - abrasion and ozone resistant.
Application: marine wet exhaust. Also suitable for bilge pump connection. Special lightweight construction for maximum flexibility. Max 40% aromatic content resistance.
Constant operation: -30 °C +100 °C (-22 °F +212 °F)

↔		↔		↻		↻		↷		⌋		
mm	in	mm	in	bar	psi	bar	psi	mm	in	%	kg/m	lb/ft
25,0	1"			3	45	15	225	50,0	1,97	100	0,550	0,37
28,0	1 1/8"			3	45	15	225	56,0	2,20	100	0,610	0,41
32,0	1 1/4"			3	45	15	225	64,0	2,52	100	0,680	0,46
35,0	1 3/8"			3	45	15	225	70,0	2,76	100	0,740	0,50
38,0	1 1/2"			3	45	15	225	76,0	2,99	100	0,800	0,54
40,0	1 9/16"			3	45	15	225	80,0	3,15	100	0,840	0,57
42,0	1 5/8"			3	45	15	225	84,0	3,31	100	0,870	0,59
45,0	1 3/4"			3	45	15	225	90,0	3,54	100	0,930	0,63
48,0	1 7/8"			3	45	15	225	96,0	3,78	100	0,990	0,67
51,0	2"			3	45	15	225	102,0	4,02	100	1,040	0,70
60,0	2 3/8"			3	45	15	225	120,0	4,72	90	1,580	1,07
63,0	2 1/2"			3	45	15	225	126,0	4,96	90	1,660	1,12
76,0	3"			3	45	15	225	152,0	5,98	90	1,970	1,33
80,0	3 1/8"			3	45	15	225	160,0	6,30	90	2,070	1,40
90,0	3 1/2"			3	45	15	225	180,0	7,09	90	2,510	1,69
102,0	4"			3	45	15	225	204,0	8,03	90	2,820	1,90
115,0	4 1/2"			3	45	15	225	230,0	9,06	90	3,000	2,02
127,0	5"			3	45	15	225	254,0	10,00	80	3,790	2,55
152,0	6"			3	45	15	225	304,0	11,97	80	4,300	2,89
203,0	8"			3	45	15	225	406,0	15,98	70	7,460	5,02

Dimensions shown may be changed without prior notice

// 605AA

**Fuel-oil S&D 10 bar (150 psi)
exceed SAE 100R4 - SAE J2006/R2 - ISO
13363/2/A+B**
Tube: black conductive NBR.

Reinforcement: high tensile textile cords with embedded steel helix wire.

Cover: black CR - abrasion, ozone and hydrocarbon resistant.

Application: fuel and oil suction and delivery. Specially designed for tank truck and general industrial applications. Also suitable for marine wet exhaust and bilge pump connection.

Constant operation: -30 °C +80 °C (-22 °F +176 °F)

↔		↔		↙		↘		↗		↘		↘	
mm	in	mm	in	bar	psi	bar	psi	mm	in	%	kg/m	lb/ft	
19,0	3/4"	30,00	1,18	10	150	30	450	76,0	2,99	100	0,590	0,40	
25,0	1"	36,00	1,42	10	150	30	450	100,0	3,94	100	0,750	0,51	
30,0	1 3/16"	41,00	1,61	10	150	30	450	120,0	4,72	100	0,890	0,60	
32,0	1 1/4"	43,00	1,69	10	150	30	450	128,0	5,04	100	0,940	0,64	
35,0	1 3/8"	46,00	1,81	10	150	30	450	140,0	5,51	100	1,020	0,69	
38,0	1 1/2"	49,00	1,93	10	150	30	450	152,0	5,98	100	1,020	0,69	
40,0	1 9/16"	51,00	2,01	10	150	30	450	160,0	6,30	100	1,140	0,77	
42,0	1 5/8"	53,00	2,09	10	150	30	450	168,0	6,61	100	1,190	0,80	
45,0	1 3/4"	56,00	2,20	10	150	30	450	180,0	7,09	100	1,260	0,85	
48,0	1 7/8"	59,00	2,32	10	150	30	450	192,0	7,56	100	1,330	0,90	
51,0	2"	62,00	2,44	10	150	30	450	204,0	8,03	100	1,410	0,95	
57,0	2 1/4"	68,00	2,68	10	150	30	450	228,0	8,98	100	1,570	1,06	
60,0	2 3/8"	73,00	2,87	10	150	30	450	240,0	9,45	100	1,980	1,34	
63,0	2 1/2"	76,00	2,99	10	150	30	450	252,0	9,92	90	2,060	1,39	
70,0	2 3/4"	83,00	3,27	10	150	30	450	280,0	11,02	90	2,300	1,55	
76,0	3"	89,00	3,50	10	150	30	450	304,0	11,97	90	2,470	1,66	
80,0	3 1/8"	94,00	3,70	10	150	30	450	320,0	12,60	90	2,650	1,79	
90,0	3 1/2"	104,00	4,09	10	150	30	450	360,0	14,17	90	3,090	2,08	
102,0	4"	116,00	4,57	10	150	30	450	408,0	16,06	90	3,440	2,32	
110,0	4 5/16"	124,00	4,88	10	150	30	450	440,0	17,32	90	4,150	2,79	
115,0	4 1/2"	129,00	5,08	10	150	30	450	460,0	18,11	90	4,320	2,91	
120,0	4 3/4"	138,00	5,43	10	150	30	450	480,0	18,90	80	5,530	3,72	
127,0	5"	145,00	5,71	10	150	30	450	508,0	20,00	80	5,810	3,91	
133,0	5 1/4"	151,00	5,94	10	150	30	450	532,0	20,94	80	6,050	4,07	
152,0	6"	170,00	6,69	10	150	25	375	608,0	23,94	80	7,230	4,86	
203,0	8"	225,00	8,86	10	150	25	375	812,0	31,97	70	11,470	7,71	



// DOCK



60DAA	Fuel-oil S&D 10 bar (150 psi) - EN 1765/S10.....	125
64AAA	Fuel-oil delivery 10 bar (150 psi) - EN 1765/L10.....	125
60NAA	Fuel-oil S&D 15 bar (225 psi) - EN 1765/S15.....	126
60GAA	Fuel-oil S&D 15 bar (225 psi) - EN 1765/S15.....	126
64DAA	Fuel-oil delivery 15 bar (225 psi) - EN 1765/L15.....	127
60PAA	Fuel-oil S&D 20 bar (300 psi) - exceeds EN 1765/S15.....	127
64PAA	Fuel-oil delivery 20 bar (300 psi) - exceeds EN 1765/L15.....	128

Dimensions shown may be changed without prior notice

// 60DAA

**Fuel-oil S&D 10 bar (150 psi)
EN 1765/S10****Tube:** black NBR.**Reinforcement:** high tensile textile cords with embedded steel helix wire.**Cover:** black CR- abrasion, ozone, sea water and hydrocarbon resistant.**Application:** crude oil and liquid petroleum products suction and delivery to/from tankers and bunkering vessels.
Max 55% aromatic content resistance.

Electrically continuous (discontinuous on request).

Built-in fittings.

Also available: 60EAA 100% aromatic content • 60FAA biofuel.

Constant operation: -20 °C +82 °C (-4 °F +180 °F)

↔		↔		↻		↻		↶		⚠		⚖	
mm	in	mm	in	bar	psi	bar	psi	mm	in	%	kg/m	lb/ft	
100,0	4"			10	150	40	600	500,0	19,69	100	8,700	5,85	
150,0	6"			10	150	40	600	750,0	29,53	100	16,700	11,23	
200,0	8"			10	150	40	600	1000,0	39,37	100	25,500	17,14	
250,0	10"			10	150	40	600	1250,0	49,21	100	35,000	23,53	
300,0	12"			10	150	40	600	1500,0	59,06	100	51,800	34,82	

// 64AAA

**Fuel-oil delivery 10 bar (150 psi)
EN 1765/L10****Tube:** black NBR.**Reinforcement:** high tensile textile cords.**Cover:** black CR- abrasion, ozone, sea water and hydrocarbon resistant.**Application:** crude oil and liquid petroleum products delivery to/from tankers and bunkering vessels.

Max 55% aromatic content resistance.

Electrically continuous (discontinuous on request).

Built-in fittings.

Also available: 64BAA 100% aromatic content • 64CAA biofuel.

Constant operation: -20 °C +82 °C (-4 °F +180 °F)

↔		↔		↻		↻		↶		⚠		⚖	
mm	in	mm	in	bar	psi	bar	psi	mm	in	%	kg/m	lb/ft	
100,0	4"			10	150	40	600	600,0	23,62		5,850	3,94	
150,0	6"			10	150	40	600	900,0	35,43		9,450	6,36	
200,0	8"			10	150	40	600	1200,0	47,24		14,100	9,48	
250,0	10"			10	150	40	600	1500,0	59,06		17,400	11,70	
300,0	12"			10	150	40	600	1800,0	70,87		24,550	16,50	

// 60NAA



**Fuel-oil S&D 15 bar (225 psi)
EN 1765/S15**

Tube: black NBR.

Reinforcement: high tensile textile cords with embedded steel helix wire.

Cover: black CR- abrasion, ozone, sea water and hydrocarbon resistant.

Application: crude oil and liquid petroleum products suction and delivery to/from tankers and bunkering vessels. Max 55% aromatic content resistance.

Electrically continuous (discontinuous on request).

Available with swaged fittings.

Constant operation: -20 °C +82 °C (-4 °F +180 °F)

↔		↔		↙		↘		↗		⚖		
mm	in	mm	in	bar	psi	bar	psi	mm	in	%	kg/m	lb/ft
76,0	3"	98,00	3,86	15	225	60	900	380,0	14,96	85	4,450	3,00
102,0	4"	128,00	5,04	15	225	60	900	510,0	20,08	85	7,660	5,15
152,0	6"	180,00	7,09	15	225	60	900	760,0	29,92	85	13,060	8,78

// 60GAA



**Fuel-oil S&D 15 bar (225 psi)
EN 1765/S15**

Tube: black NBR.

Reinforcement: high tensile textile cords with embedded steel helix wire.

Cover: black CR- abrasion, ozone, sea water and hydrocarbon resistant.

Application: crude oil and liquid petroleum products suction and delivery to/from tankers and bunkering vessels. Max 55% aromatic content resistance.

Electrically continuous (discontinuous on request).

Built-in fittings.

Also available: 60HAA 100% aromatic content • 60IAA biofuel.

Constant operation: -20 °C +82 °C (-4 °F +180 °F)

↔		↔		↙		↘		↗		⚖		
mm	in	mm	in	bar	psi	bar	psi	mm	in	%	kg/m	lb/ft
100,0	4"			15	225	60	900	500,0	19,69	100	10,100	6,79
150,0	6"			15	225	60	900	750,0	29,53	100	17,600	11,83
200,0	8"			15	225	60	900	1000,0	39,37	100	28,400	19,09
250,0	10"			15	225	60	900	1250,0	49,21	100	38,500	25,88
300,0	12"			15	225	60	900	1500,0	59,06	100	54,500	36,63

Dimensions shown may be changed without prior notice

// 64DAA

**Fuel-oil delivery 15 bar (225 psi)
EN 1765/L15****Tube:** black NBR.**Reinforcement:** high tensile textile cords.**Cover:** black CR- abrasion, ozone, sea water and hydrocarbon resistant.**Application:** crude oil and liquid petroleum products delivery to/ from tankers and bunkering vessels.

Max 55% aromatic content resistance.

Electrically continuous (discontinuous on request).

Built-in fittings.

Also available: 64EAA 100% aromatic content • 64FAA biofuel.

Constant operation: -20 °C +82 °C (-4 °F +180 °F)

↔		↔		↙		↘		↷		⌘		
mm	in	mm	in	bar	psi	bar	psi	mm	in	%	kg/m	lb/ft
100,0	4"			15	225	60	900	600,0	23,62		6,580	4,43
150,0	6"			15	225	60	900	900,0	35,43		10,500	7,06
200,0	8"			15	225	60	900	1200,0	47,24		16,100	10,82
250,0	10"			15	225	60	900	1500,0	59,06		19,900	13,38
300,0	12"			15	225	60	900	1800,0	70,87		28,500	19,16

// 60PAA

**Fuel-oil S&D 20 bar (300 psi)
exceeds EN 1765/S15****Tube:** black NBR.**Reinforcement:** high tensile textile cords with embedded steel helix wire.**Cover:** black CR - abrasion, ozone, sea water and hydrocarbon resistant.**Application:** fuel and oil suction and delivery. Designed for long service life in heavy duty applications. Also suitable for bunkering service.

Electrically continuous (discontinuous on request).

Constant operation: -20 °C +82 °C (-4 °F +180 °F)

↔		↔		↙		↘		↷		⌘		
mm	in	mm	in	bar	psi	bar	psi	mm	in	%	kg/m	lb/ft
76,0	3"	92,00	3,62	20	300	60	900	380,0	14,96	85	3,210	2,16
102,0	4"	122,00	4,80	20	300	60	900	510,0	20,08	85	5,440	3,66
152,0	6"	176,00	6,93	20	300	60	900	760,0	29,92	85	10,930	7,35
203,0	8"	233,00	9,17	20	300	60	900	1000,0	39,37	85	17,740	11,93
254,0	10"	288,00	11,34	20	300	60	900	1270,0	50,00	85	25,920	17,42
300,0	12"	340,00	13,39	20	300	60	900	1500,0	59,06	85	35,940	24,16

// 64PAA



**Fuel-oil delivery 20 bar (300 psi)
exceeds EN 1765/L15**

Tube: black NBR.

Reinforcement: high tensile textile cords - antistatic wire.

Cover: black CR - abrasion, ozone, sea water and hydrocarbon resistant.

Application: fuel and oil delivery. Designed for long service life in heavy duty applications. Also suitable for bunkering service.

Electrically continuous (discontinuous on request).

Constant operation: -20 °C +82 °C (-4 °F +180 °F)

↔		↔		↻		↻		⤴		⚡	⚖	
mm	in	mm	in	bar	psi	bar	psi	mm	in	%	kg/m	lb/ft
76,0	3"	92,00	3,62	20	300	60	900				3,310	2,23
102,0	4"	120,00	4,72	20	300	60	900				4,020	2,71
152,0	6"	172,00	6,77	20	300	60	900				6,990	4,70
203,0	8"	227,00	8,94	20	300	60	900				11,300	7,60



// FLOATING ROOF DRAIN



906AA Roof drain 10 bar (150 psi) 130

// 906AA



Roof drain 10 bar (150 psi)

Tube: black conductive NBR.

Reinforcement: high tensile textile cords with embedded steel helix wire.

Cover: black conductive NBR- abrasion, ozone and hydrocarbon resistant.

Application: rain water drainage in floating petrochemical storage tank roofs. 80% max aromatic content resistance.

Available with swaged fittings.

Also available: 905AA with Viton cover 100% aromatic content.

Constant operation: -20 °C +82 °C (-4 °F +180 °F)

↔		↔		⬇		↔		⤴		⏪		
mm	in	mm	in	bar	psi	bar	psi	mm	in	%	kg/m	lb/ft
152,0	6"	180,00	7,09	10	150	30	450	760,0	29,92	80	10,470	7,04



// RIG SUPPLY



648AA	Rig supply soft wall - Fuel-liquid mud 20 bar (300 psi).....	132
615AA	Rig supply hard wall - Fuel-liquid mud 20 bar (300 psi).....	132
622AA	Rig supply hard wall - Fuel-liquid mud.....	133
748AA	Rig supply soft wall - Bulk material 20 bar (300 psi).....	134
715AA	Rig supply hard wall - Bulk material 20 bar (300 psi).....	134
448LI	Rig supply soft wall - Potable water 20 bar (300 psi) - FDA.....	135
415LI	Rig supply hard wall - Potable water 20 bar (300 psi) - FDA.....	135

// 648AA



Rig supply soft wall - Fuel-liquid mud 20 bar (300 psi)

Tube: black conductive NBR.
Reinforcement: high tensile textile cords - antistatic wire.
Cover: black conductive CR - abrasion, ozone, hydrocarbon and fire resistant.
Application: fuel, oil and liquid mud transfer from supply vessels to offshore platforms. Also suitable for sea water pumping and barite transfer.
 Tensile end load resistance:
 ID 2" 2.000 kg
 ID 3" 4.000 kg
 ID 4" 7.000 kg
 ID ≥ 5" 10.000 kg

ABS Type approved hose assemblies.

Electrically continuous.

Constant operation: -30 °C +90 °C (-22 °F +194 °F)

↔		↔		↻		↻		⤴		⚡		⚖	
mm	in	mm	in	bar	psi	bar	psi	mm	in	%	kg/m	lb/ft	
51,0	2"	67,00	2,64	20	300	80	1200	306,0	12,05		1,880	1,27	
76,0	3"	94,00	3,70	20	300	80	1200	456,0	17,95		2,950	1,99	
102,0	4"	120,00	4,72	20	300	80	1200	612,0	24,09		3,900	2,63	
127,0	5"	147,00	5,79	20	300	80	1200	762,0	30,00		5,640	3,80	
152,0	6"	176,00	6,93	20	300	80	1200	912,0	35,91		8,030	5,40	

// 615AA



Rig supply hard wall - Fuel-liquid mud 20 bar (300 psi)

Tube: black conductive NBR.
Reinforcement: high tensile textile cords with embedded steel helix wire - antistatic wire.
Cover: black conductive CR - abrasion, ozone, hydrocarbon and fire resistant.
Application: fuel, oil and liquid mud transfer from supply vessels to offshore platforms. Also suitable for sea water pumping and barite transfer.
 Also available in self floating version. Reserve buoyancy calculated according to GMPHOM 2009 standard.
 Tensile end load resistance:
 ID 2" 2.000 kg
 ID 3" 4.000 kg
 ID 4" 7.000 kg
 ID ≥ 5" 10.000 kg

ABS Type approved hose assemblies.

Electrically continuous.

Constant operation: -30 °C +90 °C (-22 °F +194 °F)

↔		↔		↻		↻		⤴		⚡		⚖	
mm	in	mm	in	bar	psi	bar	psi	mm	in	%	kg/m	lb/ft	
51,0	2"	67,00	2,64	20	300	80	1200	255,0	10,04	100	2,210	1,49	
76,0	3"	94,00	3,70	20	300	80	1200	380,0	14,96	90	3,740	2,52	
102,0	4"	122,00	4,80	20	300	80	1200	510,0	20,08	90	5,470	3,68	
127,0	5"	149,00	5,87	20	300	80	1200	635,0	25,00	90	7,760	5,22	
152,0	6"	176,00	6,93	20	300	80	1200	760,0	29,92	90	10,200	6,86	
203,0	8"	237,00	9,33	20	300	80	1200	1015,0	39,96	90	19,060	12,81	

Dimensions shown may be changed without prior notice

// 622AA

**Rig supply hard wall - Fuel-liquid mud****Tube:** black conductive NBR.**Reinforcement:** high tensile textile cords with embedded steel helix wire - antistatic wire**Cover:** black conductive CR - abrasion, ozone, hydrocarbon and fire resistant.**Application:** fuel, oil and liquid mud transfer from supply vessels to offshore platforms. Also suitable for sea water pumping and barite transfer.

Specially designed for reeling applications and weak link couplings use.

Tensile end load resistance:

ID 3" 6.000 kg

ID ≥ 4" 10.000 kg

ABS Type approved hose assemblies.

Electrically continuous.

Constant operation: -30 °C +90 °C (-22 °F +194 °F)

↔		↔		↻		↻		⌒		⌒	⌒	
mm	in	mm	in	bar	psi	bar	psi	mm	in	%	kg/m	lb/ft
76,0	3"	98,00	3,86	40	600	160	2320	380,0	14,96	90	4,870	3,28
102,0	4"	128,00	5,04	40	600	160	2320	510,0	20,08	90	7,430	5,00
127,0	5"	157,00	6,18	35	525	140	2000	635,0	25,00	90	11,150	7,50

// 748AA



Rig supply soft wall - Bulk material 20 bar (300 psi)

Tube: black conductive NR - abrasion resistant.

Reinforcement: high tensile textile cords - antistatic wire.

Cover: black conductive CR - abrasion, ozone, hydrocarbon and fire resistant.

Application: bulk material, barite and dry cement transfer from supply vessels to offshore platforms.

Tensile end load resistance:

ID 4" 6.000 kg

ID 5" 10.000 kg

ABS Type approved hose assemblies.

Electrically continuous.

Constant operation: -30 °C +80 °C (-22 °F +176 °F)

↔		↔		↻		↻		⤵		⌋		Ⓜ	
mm	in	mm	in	bar	psi	bar	psi	mm	in	%	kg/m	lb/ft	
102,0	4"	122,00	4,80	20	300	80	1200	612,0	24,09		4,460	3,00	
127,0	5"	149,00	5,87	20	300	80	1200	762,0	30,00		6,320	4,25	

// 715AA



Rig supply hard wall - Bulk material 20 bar (300 psi)

Tube: black conductive NR - abrasion resistant.

Reinforcement: high tensile textile cords with embedded steel helix wire - antistatic wire.

Cover: black conductive CR- abrasion, ozone, hydrocarbon and fire resistant.

Application: bulk material, barite and dry cement transfer from supply vessels to offshore platforms.

Also available in self floating version. Reserve buoyancy calculated according to GMPHOM 2009 standard.

Tensile end load resistance:

ID 4" 7.000 kg

ID 5" 10.000 kg

ABS Type approved hose assemblies.

Electrically continuous.

Constant operation: -30 °C +80 °C (-22 °F +176 °F)

↔		↔		↻		↻		⤵		⌋		Ⓜ	
mm	in	mm	in	bar	psi	bar	psi	mm	in	%	kg/m	lb/ft	
102,0	4"	124,00	4,88	20	300	80	1200	510,0	20,08	90	6,060	4,08	
127,0	5"	151,00	5,94	20	300	80	1200	635,0	25,00	90	8,530	5,74	

Dimensions shown may be changed without prior notice

// 448LI



Rig supply soft wall - Potable water 20 bar (300 psi) FDA

Tube: white NR.
Reinforcement: high tensile textile cords.
Cover: orange NBR/PVC - abrasion, ozone and hydrocarbon resistant.
Application: potable water transfer from supply vessels to offshore platforms. Specially designed for reeling applications and weak link couplings use. Sterilize with 5% soda solution.
 Tensile end load resistance:
 ID 2" 2.000 kg
 ID 3" 4.000 kg
 ID 4" 7.000 kg
ABS Type approved hose assemblies.
Constant operation: -30 °C +80 °C (-22 °F +176 °F)

↔		↔		↻		↻		↵		⚖		
mm	in	mm	in	bar	psi	bar	psi	mm	in	%	kg/m	lb/ft
51,0	2"	67,00	2,64	20	300	80	1200	306,0	12,05		1,880	1,27
76,0	3"	94,00	3,70	20	300	80	1200	456,0	17,95		2,950	1,99
102,0	4"	120,00	4,72	20	300	80	1200	612,0	24,09		3,980	2,68

// 415LI



Rig supply hard wall - Potable water 20 bar (300 psi) FDA

Tube: white NR.
Reinforcement: high tensile textile cords with embedded steel helix wire.
Cover: orange NBR/PVC - abrasion, ozone and hydrocarbon resistant.
Application: potable water transfer from supply vessels to offshore platforms. Sterilize with 5% soda solution. Also available in self floating version.
 Reserve bouyancy calculated according to GMPHOM 2009 standard.
 Tensile end load resistance:
 ID 2" 2.000 kg
 ID 3" 4.000 kg
 ID 4" 7.000 kg
ABS Type approved hose assemblies.
Constant operation: -30 °C +80 °C (-22 °F +176 °F)

↔		↔		↻		↻		↵		⚖		
mm	in	mm	in	bar	psi	bar	psi	mm	in	%	kg/m	lb/ft
51,0	2"	67,00	2,64	20	300	80	1200	255,0	10,04	100	2,230	1,50
76,0	3"	94,00	3,70	20	300	80	1200	380,0	14,96	90	3,800	2,56
102,0	4"	122,00	4,80	20	300	80	1200	510,0	20,08	90	5,580	3,76

// COMPLETE HOSE & FITTING SOLUTIONS

Hose	Structure	Self Floating Version	ID range in	WP bar	Safety Factor
------	-----------	-----------------------	-------------	--------	---------------

FUEL, LIQUID MUD, SEA WATER, BULK MATERIAL

	648AA	Soft Wall		2" 3" 4" 5" 6"	20	4:1
	615AA	Hard Wall		2" 3" 4" 5" 6" 8"	20	4:1
	622AA (formerly 652AAZ)	Hard Wall		3" 4" 5"	40 bar up to 4" ID 35 bar ID 5"	4:1

BULK MATERIAL

	748AA	Soft Wall		4" 5"	20	4:1
	715AA	Hard Wall		4" 5"	20	4:1

POTABLE WATER

	448LI	Soft Wall		2" 3" 4"	20	4:1
	415LI	Hard Wall		2" 3" 4"	20	4:1

Dimensions shown may be changed without prior notice

Tensile end Load Resistance kg	Working Temperature	Flammability test	ABS Type Approved Fittings				Certification
			NPT Male	NPT Male for Hook hose lifter	Fixed Flange ASA 150	Swivel Flange ASA 150	

ID 2" ID 3" ID 4" ID ≥ 5"	2.000 Kg 4.000 Kg 7.000 Kg 10.000 Kg	-30 / +90 °C	EN 1762 - Annex A	●	●	●	●	ABS
ID 2" ID 3" ID 4" ID ≥ 5"	2.000 Kg 4.000 Kg 7.000 Kg 10.000 Kg	-30 / +90 °C	EN 1762 - Annex A	●	●	●	●	ABS
ID 3" ID ≥ 4"	6.000 Kg 10.000 Kg	-30 / +90 °C	EN 1762 - Annex A	●	●	●	●	ABS

ID 4" ID ≥ 5"	7.000 Kg 10.000 Kg	-30 / +80 °C	EN 1762 - Annex A	●	●	●	●	ABS
ID 4" ID ≥ 5"	7.000 Kg 10.000 Kg	-30 / +80 °C	EN 1762 - Annex A	●	●	●	●	ABS

ID 2" ID 3" ID 4"	2.000 Kg 4.000 Kg 7.000 Kg	-30 / +80 °C		●	●	●	●	ABS FDA
ID 2" ID 3" ID 4"	2.000 Kg 4.000 Kg 7.000 Kg	-30 / +80 °C		●	●	●	●	ABS FDA





151AA	Compressed air 20 bar (300 psi) - Heavy duty mining.....	140
151AK	Compressed air 20 bar (300 psi) - Heavy duty mining.....	140
157AK	Compressed air 27 bar (400 psi) - Heavy duty mining.....	141
189AK	Air-water delivery - PVC - FRAS - AS 2660/A - AS/NZS - 2554/A.....	141
146AK	Compressed air-water 70 bar (1000 psi) - Steel braided.....	142
141AA	Compressed air 40 bar (600 psi) - Steel braided - FRAS - exceeds AS 2660/B.....	142
289GG	Mine dewatering - PVC - Lay flat.....	143
240AA	Air-water delivery 20 bar (300 psi) - FRAS - exceeds AS 2660/B.....	143
241AA	Air-water delivery 35 bar (525 psi) - AS 2660/B.....	143
225AA	General purpose S&D 10 bar (150 psi) - FRAS - exceeds AS 2660/C.....	144
245AA	General purpose delivery & light suction 27 bar (400 psi) - Crush resistant - FRAS - exceeds AS 2660/B.....	144
756AA	Gunite 14 bar (200 psi) - FRAS - exceeds AS 2660/C.....	145
765AA	Stone dust 7 bar (100 psi) - FRAS.....	145
706AA	Abrasive slurry S&D 10 bar (150 psi) - Muff couplings.....	145
776AA	Mineral sampling 35 bar (525 psi).....	146
776HA	Mineral sampling 35 bar (525 psi).....	146
714HA	Drill cutting suction 5 bar (75 psi) - Corrugated.....	146
612AA	Nitro blast handling 20 bar (300 psi).....	147
964AA	Cable protection - FRAS - AS 1802 - AS 2660.....	147

// 151AA



Compressed air 20 bar (300 psi) - Heavy duty mining

Tube: black SBR/NBR - oil mist resistant.

Reinforcement: high tensile textile cords.

Cover: black SBR - abrasion and ozone resistant.

Application: compressed air designed for heavy duty mining applications.

Constant operation: -30 °C +80 °C (-22 °F +176 °F)

↔		↔		↙		↘		↵		%		⚖	
mm	in	mm	in	bar	psi	bar	psi	mm	in			kg/m	lb/ft
13,0	1/2"	23,00	0,91	20	300	60	900					0,420	0,29
19,0	3/4"	31,00	1,22	20	300	60	900					0,690	0,47
25,0	1"	37,00	1,46	20	300	60	900					0,860	0,58
38,0	1 1/2"	52,00	2,05	20	300	60	900					1,260	0,85
51,0	2"	67,00	2,64	20	300	60	900					2,190	1,48

// 151AK



Compressed air 20 bar (300 psi) - Heavy duty mining

Tube: black SBR/NBR - oil mist resistant.

Reinforcement: high tensile textile cords.

Cover: yellow SBR - abrasion and ozone resistant.

Application: compressed air designed for heavy duty mining applications.

Constant operation: -30 °C +80 °C (-22 °F +176 °F)

↔		↔		↙		↘		↵		%		⚖	
mm	in	mm	in	bar	psi	bar	psi	mm	in			kg/m	lb/ft
13,0	1/2"	23,00	0,91	20	300	60	900					0,420	0,29
19,0	3/4"	31,00	1,22	20	300	60	900					0,690	0,47
25,0	1"	37,00	1,46	20	300	60	900					0,860	0,58
38,0	1 1/2"	52,00	2,05	20	300	60	900					1,260	0,85
51,0	2"	67,00	2,64	20	300	60	900					2,200	1,48

Dimensions shown may be changed without prior notice

// 157AK



Compressed air 27 bar (400 psi) - Heavy duty mining

Tube: black SBR/NBR - oil mist resistant.
Reinforcement: high tensile textile cords.
Cover: yellow SBR - abrasion and ozone resistant.
Application: compressed air designed for heavy duty mining applications.
Constant operation: -30 °C +80 °C (-22 °F +176 °F)

↔		↔		↙		↘		⤴		⚖		
mm	in	mm	in	bar	psi	bar	psi	mm	in	%	kg/m	lb/ft
19,0	3/4"	29,00	1,14	27	400	81	1200	190,0	7,48		0,550	0,37
25,0	1"	35,00	1,38	27	400	81	1200	250,0	9,84		0,700	0,48
32,0	1 1/4"	44,00	1,73	27	400	81	1200	320,0	12,60		0,920	0,62
38,0	1 1/2"	50,00	1,97	27	400	81	1200	380,0	14,96		1,050	0,71
51,0	2"	65,00	2,56	27	400	81	1200	510,0	20,08		1,690	1,14

// 189AK



Air-water delivery - PVC - FRAS AS 2660/A - AS/NZS - 2554/A

Tube: black antistatic PVC.
Reinforcement: high tensile textile cords.
Cover: yellow ribbed PVC with longitudinal antistatic stripes - abrasion and ozone resistant.
Application: compressed air in underground mining applications. Specially designed for roof bolting applications.
Constant operation: -5 °C +60 °C (+23 °F +140 °F)

↔		↔		↙		↘		⤴		⚖		
mm	in	mm	in	bar	psi	bar	psi	mm	in	%	kg/m	lb/ft
13,0	1/2"	21,00	0,83	20	300	70	1000	104,0	4,09		0,285	0,20
19,0	3/4"	29,00	1,14	20	300	70	1000	152,0	5,98		0,500	0,34
25,0	1"	35,00	1,38	35	525	70	1000	200,0	7,87		0,640	0,44
38,0	1 1/2"	48,00	1,89	20	300	70	1000	304,0	11,97		0,960	0,65
50,0	2"	63,00	2,48	20	300	70	1000	400,0	15,75		1,415	0,96

// 146AK



MSHA

Compressed air-water 70 bar (1000 psi) - Steel braided

Tube: black SBR/NBR - oil mist resistant.

Reinforcement: one or two high tensile steel wire braids.

Cover: yellow SBR/NBR - abrasion, ozone, hydrocarbon and flame resistant - pin pricked.

Application: high pressure compressed air and water in heavy duty mining where long service life and maximum safety is required. Ideal for water spraying in mining dust control operation.

Constant operation: -30 °C +90 °C (-22 °F +200 °F)

↔		↔		↙		↘		⤴		⌒	⌒	⌒
mm	in	mm	in	bar	psi	bar	psi	mm	in	%	kg/m	lb/ft
19,0	3/4"	28,00	1,10	70	1000	280	4000	95,0	3,74		0,600	0,41
25,0	1"	34,00	1,34	70	1000	280	4000	125,0	4,92		0,790	0,54
32,0	1 1/4"	41,00	1,61	70	1000	280	4000	160,0	6,30		1,030	0,70
38,0	1 1/2"	49,00	1,93	70	1000	280	4000	190,0	7,48		1,600	1,08
51,0	2"	63,00	2,48	70	1000	280	4000	255,0	10,04		2,180	1,47

// 141AA



Compressed air 40 bar (600 psi) - Steel braided - FRAS exceeds AS 2660/B

Tube: black conductive SBR/NR - oil mist resistant.

Reinforcement: high tensile steel wire braids.

Cover: black conductive SBR - abrasion, ozone and fire resistant.

Application: high pressure compressed air and water in heavy duty "long wall" mining where long service life and maximum safety is required.

Constant operation: -30 °C +80 °C (-22 °F +176 °F)

↔		↔		↙		↘		⤴		⌒	⌒	⌒
mm	in	mm	in	bar	psi	bar	psi	mm	in	%	kg/m	lb/ft
76,0	3"	90,00	3,54	40	600	120	1750	380,0	14,96		3,040	2,05
102,0	4"	118,00	4,65	40	600	120	1750	510,0	20,08		3,990	2,69

Dimensions shown may be changed without prior notice

// 289GG



Mine dewatering - PVC - Lay flat

Tube: green PVC.
Reinforcement: high tensile textile cords.
Cover: green PVC - abrasion, ozone and cut resistant.
Application: lay flat water discharge for heavy duty applications. Specially designed for mine and construction sites dewatering. High end load resistance.
Constant operation: -10 °C +60 °C (+14 °F +140 °F)

↻		↻		↻		↻		↻		↻	↻	
mm	in	mm	in	bar	psi	bar	psi	mm	in	%	kg/m	lb/ft
102,0	4"	113,00	4,45	14	200	48	720				1,600	1,08
157,0	6 3/16"	167,00	6,57	10	150	40	600				3,180	2,14
208,0	8 3/16"	220,00	8,66	10	150	40	600				4,970	3,35

// 240AA



Air-water delivery 20 bar (300 psi) - FRAS exceeds AS 2660/B

Tube: black conductive SBR/NR.
Reinforcement: high tensile textile cords.
Cover: black conductive SBR - abrasion, ozone and fire resistant.
Application: air, water and stone dust delivery in underground mines.
Constant operation: -30 °C +80 °C (-22 °F +176 °F)

↻		↻		↻		↻		↻		↻	↻	
mm	in	mm	in	bar	psi	bar	psi	mm	in	%	kg/m	lb/ft
13,0	1/2"	23,00	0,91	20	300	80	1200	78,0	3,07		0,350	0,24
19,0	3/4"	31,00	1,22	20	300	80	1200	114,0	4,49		0,520	0,35
25,0	1"	37,00	1,46	20	300	80	1200	150,0	5,91		0,750	0,51
32,0	1 1/4"	46,00	1,81	20	300	80	1200	192,0	7,56		1,000	0,68
38,0	1 1/2"	52,00	2,05	20	300	80	1200	228,0	8,98		1,130	0,76
51,0	2"	67,00	2,64	20	300	80	1200	306,0	12,05		1,600	1,08
63,0	2 1/2"	79,00	3,11	20	300	80	1200	378,0	14,88		2,220	1,50
76,0	3"	92,00	3,62	20	300	70	1000	456,0	17,95		2,620	1,77
102,0	4"	118,00	4,65	20	300	70	1000	612,0	24,09		3,430	2,31

// 241AA



Air-water delivery 35 bar (525 psi) AS 2660/B

Tube: black conductive SBR/NR.
Reinforcement: high tensile textile cords.
Cover: black conductive SBR - abrasion, ozone and fire resistant.
Application: air, water and stone dust delivery in underground mines.
Constant operation: -30 °C +80 °C (-22 °F +176 °F)

↻		↻		↻		↻		↻		↻	↻	
mm	in	mm	in	bar	psi	bar	psi	mm	in	%	kg/m	lb/ft

// 225AA



General purpose S&D 10 bar (150 psi) - FRAS exceeds AS 2660/C

Tube: black conductive SBR/NR.

Reinforcement: high tensile textile cords with embedded steel helix wire.

Cover: black conductive SBR - abrasion, ozone and fire resistant.

Application: water and stone dust suction and delivery. Also suitable for methane drainage/extraction in underground coal mines.

Constant operation: -30 °C +80 °C (-22 °F +176 °F)

↔		↔		↙		↘		⤴		⤵		⚖	
mm	in	mm	in	bar	psi	bar	psi	mm	in	%	kg/m	lb/ft	
51,0	2"	62,00	2,44	10	150	40	600	204,0	8,03	100	1,310	0,89	
76,0	3"	89,00	3,50	10	150	40	600	304,0	11,97	90	2,690	1,81	
102,0	4"	116,00	4,57	10	150	40	600	408,0	16,06	90	4,080	2,75	
152,0	6"	170,00	6,69	10	150	40	600	760,0	29,92	80	7,350	4,94	

// 245AA



General purpose delivery & light suction 27 bar (400 psi) - Crush resistant - FRAS exceeds AS 2660/B

Tube: black conductive SBR/NR.

Reinforcement: high tensile textile braids.

Cover: black conductive SBR - abrasion, ozone and fire resistant.

Application: air and water delivery-light suction. Special heavy wall braided construction for vacuum, crush and kink resistance. Ideal for methane drainage/extraction in underground coal mines. Vacuum resistance 60%.

Constant operation: -30 °C +80 °C (-22 °F +176 °F)

↔		↔		↙		↘		⤴		⤵		⚖	
mm	in	mm	in	bar	psi	bar	psi	mm	in	%	kg/m	lb/ft	
51,0	2"	73,00	2,87	27	400	81	1200			60	2,450	1,65	

Dimensions shown may be changed without prior notice

// 756AA



Gunite 14 bar (200 psi) - FRAS exceeds AS 2660/C

Tube: black conductive NR - abrasion resistant.
Reinforcement: high tensile textile cords.
Cover: black conductive SBR - abrasion, ozone and fire resistant.
Application: gunite.
Constant operation: -30 °C +80 °C (-22 °F +176 °F)

↔		↔		↙		↘		⤴		⚖		
mm	in	mm	in	bar	psi	bar	psi	mm	in	%	kg/m	lb/ft
38,0	1 1/2"	62,00	2,44	14	200	56	800				2,200	1,48
51,0	2"	75,00	2,95	14	200	56	800				2,810	1,89

// 765AA



Stone dust 7 bar (100 psi) - FRAS

Tube: black conductive SBR/NR - abrasion resistant.
Reinforcement: high tensile textile cords.
Cover: black conductive SBR - abrasion, ozone and fire resistant.
Application: "Stone dusting" in underground mines. Also suitable for air and water delivery.
Constant operation: -30 °C +80 °C (-22 °F +176 °F)

↔		↔		↙		↘		⤴		⚖		
mm	in	mm	in	bar	psi	bar	psi	mm	in	%	kg/m	lb/ft
32,0	1 1/4"	46,00	1,81	7	100	28	400				1,010	0,68
51,0	2"	65,00	2,56	7	100	28	400				1,510	1,02

// 706AA



Abrasive slurry S&D 10 bar (150 psi) - Muff couplings

Tube: black conductive NR - Abrasion resistance 50 mm³ (ISO 4649/A).
Reinforcement: high tensile textile cords with embedded steel helix wire.
Cover: black conductive SBR/NR - abrasion and ozone resistant.
Application: bulk material and abrasive slurries suction and delivery in heavy duty mining. Designed for muff coupling use.
Constant operation: -30 °C +80 °C (-22 °F +176 °F)

↔		↔		↙		↘		⤴		⚖		
mm	in	mm	in	bar	psi	bar	psi	mm	in	%	kg/m	lb/ft
51,0	2"	69,00	2,72	10	150	30	450	204,0	8,03	90	2,290	1,54
76,0	3"	100,00	3,94	10	150	30	450	304,0	11,97	90	4,350	2,93
102,0	4"	126,00	4,96	10	150	30	450	408,0	16,06	90	5,750	3,87
127,0	5"	155,00	6,10	10	150	30	450	635,0	25,00	80	8,370	5,63
152,0	6"	182,00	7,17	10	150	25	375	760,0	29,92	80	10,840	7,29
203,0	8"	235,00	9,25	10	150	25	375	1015,0	39,96	70	16,010	10,76
254,0	10"	286,00	11,26	10	150	25	375	1270,0	50,00	60	20,180	13,57
305,0	12"	343,00	13,50	10	150	25	375	1525,0	60,04	60	29,480	19,82

// 776AA



Mineral sampling 35 bar (525 psi)

Tube: black conductive NR - abrasion resistant.
Reinforcement: high tensile textile cords with embedded steel helix wire.
Cover: black conductive SBR/NR - abrasion and ozone resistant.
Application: mineral recovery in sampling operations.
Constant operation: -30 °C +80 °C (-22 °F +176 °F)

↔		↔		↻		↻		⤴		⚖		
mm	in	mm	in	bar	psi	bar	psi	mm	in	%	kg/m	lb/ft
51,0	2"	77,00	3,03	35	525	105	1530	204,0	8,03	100	3,000	2,02
76,0	3"	106,00	4,17	35	525	105	1530	304,0	11,97	90	4,950	3,33
102,0	4"	134,00	5,28	35	525	105	1530	408,0	16,06	90	7,320	4,92

// 776HA



Mineral sampling 35 bar (525 psi)

Tube: Red NR - abrasion resistant.
Reinforcement: high tensile textile cords with embedded steel helix wire.
Cover: black conductive SBR/NR - abrasion and ozone resistant.
Application: mineral recovery in sampling operations.
Constant operation: -30 °C +80 °C (-22 °F +176 °F)

↔		↔		↻		↻		⤴		⚖		
mm	in	mm	in	bar	psi	bar	psi	mm	in	%	kg/m	lb/ft
76,0	3"	106,00	4,17	35	525	105	1530	304,0	11,97	90	4,890	3,29

// 714HA



Drill cutting suction 5 bar (75 psi) - Corrugated

Tube: Red NR - abrasion resistant.
Reinforcement: high tensile textile cords with embedded steel helix wire - antistatic wire.
Cover: black conductive SBR/NR - abrasion and ozone resistant.
Application: bulk material suction and delivery. Specially designed for drill cutting suction in mobile drilling rigs. Corrugated construction for maximum flexibility.
Constant operation: -30 °C +80 °C (-22 °F +176 °F)

↔		↔		↻		↻		⤴		⚖		
mm	in	mm	in	bar	psi	bar	psi	mm	in	%	kg/m	lb/ft
51,0	2"	61,00	2,40	5	75	15	225	127,0	5,00	100	1,190	0,80
63,0	2 1/2"	75,00	2,95	5	75	15	225	157,0	6,18	90	1,860	1,26
76,0	3"	90,00	3,54	5	75	15	225	190,0	7,48	90	2,560	1,73
102,0	4"	116,00	4,57	5	75	15	225	255,0	10,04	90	3,580	2,41
115,0	4 1/2"	129,00	5,08	5	75	15	225	287,0	11,30	90	4,070	2,74
127,0	5"	141,00	5,55	5	75	15	225	318,0	12,52	80	4,710	3,17
152,0	6"	166,00	6,54	5	75	15	225	380,0	14,96	80	5,580	3,76

Dimensions shown may be changed without prior notice

// 612AA



Nitro blast handling 20 bar (300 psi)

Tube: black conductive NBR - abrasion resistant.

Reinforcement: high tensile textile cords with embedded steel helix wire.

Cover: black conductive CR - abrasion, ozone, hydrocarbon and fire resistant.

Application: explosive handling in mobile delivery units. Specially designed for heavy duty reeling applications.

Constant operation: -30 °C +80 °C (-22 °F +176 °F)

↔		↔		↻		↻		⤴		⚖		
mm	in	mm	in	bar	psi	bar	psi	mm	in	%	kg/m	lb/ft
51,0	2"	71,00	2,80	20	300	60	900	255,0	10,04	70	2,800	1,89
63,0	2 1/2"	83,00	3,27	20	300	60	900	315,0	12,40	70	2,980	2,01

// 964AA



**Cable protection - FRAS
AS 1802 - AS 2660**

Tube: black conductive SBR/NR.

Reinforcement: high tensile textile cords.

Cover: black conductive SBR - abrasion, ozone and fire resistant.

Application: cable protection in underground mines. Also suitable for light duty air and water delivery max 5 bar (75 psi).

Constant operation: -30 °C +80 °C (-22 °F +176 °F)

↔		↔		↻		↻		⤴		⚖		
mm	in	mm	in	bar	psi	bar	psi	mm	in	%	kg/m	lb/ft
13,0	1/2"	21,00	0,83	5	75	15	225				0,240	0,17
16,0	5/8"	24,00	0,94	5	75	15	225				0,280	0,19
19,0	3/4"	29,00	1,14	5	75	15	225				0,410	0,28
25,0	1"	35,00	1,38	5	75	15	225				0,510	0,35
32,0	1 1/4"	42,00	1,65	5	75	15	225				0,630	0,43
38,0	1 1/2"	48,00	1,89	5	75	15	225				0,730	0,50
45,0	1 3/4"	55,00	2,17	5	75	15	225				0,850	0,58
51,0	2"	61,00	2,40	5	75	15	225				0,960	0,65



// INDUSTRIAL FITTINGS

// COMPRESSED AIR	150
// WATER.....	165
// HYGIENIC - FOOD.....	179
// STEAM	184
// SYMMETRIC GUILLEMIN	191
// SYMMETRIC DSP & AR (NF S 61.704 - NF S 61.705).....	203
// GFR - ROUND THREAD COUPLING NF E 29.579	205
// STORZ	207
// TANKWAGEN.....	212
// CAM & GROOVE	218
// COMBINATION NIPPLE	247
// EN 14 420-5 / DIN 2817	252
// AVIATION	255
// SANDBLAST	259
// MORTAR	263
// CONCRETE.....	267
// FLANGED FITTING	271
// CLAMPS	282
// FERRULE & CRIMPING RING.....	297



// COMPRESSED AIR

// EXPRESS NF E 29.573	151
// TYPE A CLAW COUPLING (EUROPEAN TYPE).....	153
// TYPE B CLAW COUPLING (U.S. TYPE).....	156
// TYPE S CLAW COUPLING (AUSTRALIAN TYPE).....	159
// HOSE MENDER	161
// CLAW COUPLING - ACCESSORY.....	162
// CLAW COUPLING - CLAMP & FERRULE.....	163

Dimensions shown may be changed without prior notice

// EXPRESS NF E 29.573**// EXPRESS NF E 29.573****Hose shank complete with seal - Brass**

Item Code	Product Code	Hose ID		Claw Distance Internal	Claw Distance External
		in	mm	mm	mm
2300699	I819E300-010041	3/8"	10,0	41	57
2300701	I819E300-013041	1/2"	13,0	41	57
2300702	I819E300-016041	5/8"	16,0	41	57
2300703	I819E300-019041	3/4"	19,0	41	57
2300704	I819E300-025041	1"	25,0	41	57

To assemble the insert with "R5YBFF0" crimping ring, consult chapter "Ferrule & Crimping ring"

// EXPRESS NF E 29.573**BSPP Male complete with seal - Brass**

Item Code	Product Code	Head DN side 1		Claw Distance Internal side 1	Claw Distance External side 1	Technical Note side 1	Thread type 2	Thread 2
		in	mm	mm	mm			in
2300334	I8A9E206-041017	-	41,0	41	57	-	BSPP	3/8"
2300335	I8A9E206-041021	-	41,0	41	57	-	BSPP	1/2"
2300336	I8A9E206-041027	-	41,0	41	57	-	BSPP	3/4"
2300337	I8A9E206-041034	-	41,0	41	57	-	BSPP	1"

// EXPRESS NF E 29.573**BSPP Female complete with seal - Brass**

Item Code	Product Code	Head DN side 1		Claw Distance Internal side 1	Claw Distance External side 1	Technical Note side 1	Thread type 2	Thread 2
		in	mm	mm	mm			in
2300340	I8A9E306-041017	-	41,0	41	57	-	BSPP	3/8"
2300341	I8A9E306-041021	-	41,0	41	57	-	BSPP	1/2"
2300342	I8A9E306-041027	-	41,0	41	57	-	BSPP	3/4"
2300343	I8A9E306-041034	-	41,0	41	57	-	BSPP	1"

// EXPRESS NF E 29.573**Blank cap complete with seal - Brass**

Item Code	Product Code	Head DN side 1	Head DN side 1	Claw Distance Internal side 1	Claw Distance External side 1	Technical Note side 1
		in	mm	mm	mm	
2301099	I8A9E400-041000	-	41,0	41	57	-

// EXPRESS NF E 29.573**Seal - NBR**

Item Code	Product Code	DN	DN
		mm	in
2301807	INJM9E-041	41	1 5/8"

// EXPRESS NF E 29.573**Clamp - 2 gripping finger type - Plated steel**

Item Code	Product Code	Hose ID	Hose ID	Hose OD (min)	Hose OD (max)
		in	mm	mm	mm
2302138	I1LG2E-013020	1/2"	13,0	19,0	21,0
2302139	I1LG2E-016026	5/8"	16,0	25,0	27,0
2302140	I1LG2E-019029	3/4"	19,0	28,0	30,0
2302141	I1LG2E-025035	1"	25,0	34,0	36,0

Dimensions shown may be changed without prior notice

// TYPE A CLAW COUPLING (EUROPEAN TYPE)

// TYPE A CLAW COUPLING (EUROPEAN TYPE) - WITH SAFETY PIN HOLES

Hose shank with safety collar and safety pin holes - complete with seal - Plated steel



Item Code	Product Code	Hose ID	Hose ID	Claw Distance Internal	Claw Distance External
		in	mm	mm	mm
2306889	I91C4300-010042	3/8"	10,0	42	63
2304835	I91C4300-013042	1/2"	13,0	42	63
2305227	I91C4300-019042	3/4"	19,0	42	63
2304830	I91C4300-025042	1"	25,0	42	63
2306890	I91C4300-032042	1 1/4"	32,0	42	63

To assemble the insert with "R5YBFF0" crimping ring, consult chapter "Ferrule & Crimping ring"

// TYPE A CLAW COUPLING (EUROPEAN TYPE) - WITH SAFETY PIN HOLES

BSPT Male with safety pin holes - complete with seal - Plated steel



Item Code	Product Code	Head DN side 1	Head DN side 1	Claw Distance Internal side 1	Claw Distance External side 1	Technical Note side 1	Thread type 2	Thread 2
		in	mm	mm	mm			in
2306893	I9AC4206-042017	-	42,0	42	63	-	BSPP	3/8"
2304836	I9AC4206-042021	-	42,0	42	63	-	BSPP	1/2"
2304846	I9AC4206-042027	-	42,0	42	63	-	BSPP	3/4"
2304831	I9AC4206-042034	-	42,0	42	63	-	BSPP	1"
2306894	I9AC4206-042042	-	42,0	42	63	-	BSPP	1 1/4"

// TYPE A CLAW COUPLING (EUROPEAN TYPE) - WITH SAFETY PIN HOLES

BSPP Female with safety pin holes - complete with seal - Plated steel



Item Code	Product Code	Head DN side 1	Head DN side 1	Claw Distance Internal side 1	Claw Distance External side 1	Technical Note side 1	Thread type 2	Thread 2
		in	mm	mm	mm			in
2306891	I9AC4306-042017	-	42,0	42	63	-	BSPP	3/8"
2304834	I9AC4306-042021	-	42,0	42	63	-	BSPP	1/2"
2304844	I9AC4306-042027	-	42,0	42	63	-	BSPP	3/4"
2304829	I9AC4306-042034	-	42,0	42	63	-	BSPP	1"
2306892	I9AC4306-042042	-	42,0	42	63	-	BSPP	1 1/4"

// TYPE A CLAW COUPLING (EUROPEAN TYPE) - WITH SAFETY PIN HOLES

Blank cap with safety pin holes - complete with seal - Plated steel



Item Code	Product Code	Head DN side 1	Head DN side 1	Claw Distance Internal side 1	Claw Distance External side 1	Technical Note side 1
		in	mm	mm	mm	
2306895	I9AC4400-042000	-	42,0	42	63	-

// TYPE A CLAW COUPLING (EUROPEAN TYPE) - WITH SAFETY PIN HOLES

Three way connector with safety pin holes - complete with seal - Plated steel



Item Code	Product Code	Head DN side 1	Head DN side 1	Claw Distance Internal side 1	Claw Distance External side 1	Technical Note side 1
		in	mm	mm	mm	
2306896	I9YC4001	-	42,0	42	63	-

// TYPE A CLAW COUPLING (EUROPEAN TYPE) - DIN 3489

Seal - NBR



Item Code	Product Code	DN	DN
		mm	in
2303056	INJM9L-042	42	1 5/8"

// TYPE A CLAW COUPLING (EUROPEAN TYPE) - DIN 3489

Seal - Silicone



Item Code	Product Code	DN	DN
		mm	in
2304439	IOJM9L-042	42	1 5/8"

Dimensions shown may be changed without prior notice

// TYPE A CLAW COUPLING (EUROPEAN TYPE)**Claw clamp (A-Europe) - DIN 20 039 B - Malleable iron**

Item Code	Product Code	Hose ID	Hose ID	Hose OD (min)	Hose OD (max)
		in	mm	mm	mm
2302828	I9LG2A-013026	1/2"	13,0	22,0	29,0
2302829	I9LG2A-019030	3/4"	19,0	28,0	32,0
2302830	I9LG2A-025039	1"	25,0	35,0	42,0
2303974	I9LG2A-035049	1 3/8"	35,0	45,0	53,0

// TYPE B CLAW COUPLING (U.S. TYPE)**// TYPE B CLAW COUPLING (U.S. TYPE) - WITH SAFETY PIN HOLES****Hose shank with safety collar and safety pin holes - complete with seal - Malleable iron**

Item Code	Product Code	Hose ID		Claw Distance Internal	Claw Distance External
		in	mm		
2303335	I919K300-010041	3/8"	10,0	41	62
2302919	I919K300-013041	1/2"	13,0	41	62
2302920	I919K300-019041	3/4"	19,0	41	62
2302921	I919K300-025041	1"	25,0	41	62

To assemble the insert with "R5YBFF0" crimping ring, consult chapter "Ferrule & Crimping ring"

// TYPE B CLAW COUPLING (U.S. TYPE) - WITH SAFETY PIN HOLES**Hose shank with safety collar and safety pin holes - 4 Lug type - complete with seal - Malleable iron**

Item Code	Product Code	Hose ID		Claw Distance Internal	Claw Distance External
		in	mm		
2303366	I919K300-032041	1 1/4"	32,0	41	62
2303367	I919K300-038041	1 1/2"	38,0	41	62
2303368	I919K300-051041	2"	51,0	41	62

// TYPE B CLAW COUPLING (U.S. TYPE) - WITH SAFETY PIN HOLES**NPT Male with safety pin holes - complete with seal - Malleable iron**

Item Code	Product Code	Head DN side 1	Head DN side 1	Claw Distance Internal side 1	Claw Distance External side 1	Technical Note side 1	Thread type 2	Thread 2
		in	mm	mm	mm			in
2303344	I9A9K228-041013	-	41,0	41	62	-	NPT	1/4"
2303345	I9A9K228-041017	-	41,0	41	62	-	NPT	3/8"
2302922	I9A9K228-041021	-	41,0	41	62	-	NPT	1/2"
2302923	I9A9K228-041027	-	41,0	41	62	-	NPT	3/4"
2302924	I9A9K228-041034	-	41,0	41	62	-	NPT	1"

Dimensions shown may be changed without prior notice

// TYPE B CLAW COUPLING (U.S. TYPE) - WITH SAFETY PIN HOLES

NPT Female with safety pin holes - complete with seal - Malleable iron



Item Code	Product Code	Head DN side 1	Head DN side 1	Claw Distance Internal side 1	Claw Distance External side 1	Technical Note side 1	Thread type 2	Thread 2
		in	mm	mm	mm			in
2303354	I9A9K328-041013	-	41,0	41	62	-	NPT	1/4"
2303355	I9A9K328-041017	-	41,0	41	62	-	NPT	3/8"
2302925	I9A9K328-041021	-	41,0	41	62	-	NPT	1/2"
2302926	I9A9K328-041027	-	41,0	41	62	-	NPT	3/4"
2302927	I9A9K328-041034	-	41,0	41	62	-	NPT	1"

// TYPE B CLAW COUPLING (U.S. TYPE) - WITH SAFETY PIN HOLES

NPT Female with safety pin holes - 4 Lugs - complete with seal - Malleable iron



Item Code	Product Code	Head DN side 1	Head DN side 1	Claw Distance Internal side 1	Claw Distance External side 1	Technical Note side 1	Thread type 2	Thread 2
		in	mm	mm	mm			in
2303372	I9A9K328-041042	-	41,0	41	62	-	NPT	1"1/4
2303373	I9A9K328-041049	-	41,0	41	62	-	NPT	1"1/2
2303374	I9A9K328-041060	-	41,0	41	62	-	NPT	2"

// TYPE B CLAW COUPLING (U.S. TYPE) - WITH SAFETY PIN HOLES

Blank cap with safety pin holes - complete with seal - Malleable iron



Item Code	Product Code	Head DN side 1	Head DN side 1	Claw Distance Internal side 1	Claw Distance External side 1	Technical Note side 1
		in	mm	mm	mm	
2303362	I9A9K400-041000	-	41,0	41	62	-

// TYPE B CLAW COUPLING (U.S. TYPE) - WITH SAFETY PIN HOLES**Three way connector with safety pin holes - complete with seal - Malleable iron**

Item Code	Product Code	Head DN side 1	Head DN side 1	Claw Distance Internal side 1	Claw Distance External side 1	Technical Note side 1
		in	mm	mm	mm	
2303052	I9Y9K003	-	41,0	41	62	-

// TYPE B CLAW COUPLING (U.S. TYPE) - WITH SAFETY PIN HOLES**Seal - NBR**

Item Code	Product Code	DN	DN
		mm	in
2305661	INJM9K-041	41	1 5/8"

// TYPE B CLAW COUPLING (U.S. TYPE) - WITH SAFETY PIN HOLES**Claw clamp (B-U.S.) - Malleable iron**

Item Code	Product Code	Hose ID	Hose ID	Hose OD (min)	Hose OD (max)
		in	mm	mm	mm
2304357	I9LG2B-010021	3/8"	10,0	17,5	22,2
2305068	I9LG2B-013027	1/2"	13,0	21,0	27,0
2302928	I9LG2B-013028	1/2"	13,0	25,4	30,1
2302929	I9LG2B-019031	3/4"	19,0	28,6	33,3
2304358	I9LG2B-025035	1"	25,0	33,0	38,0
2302930	I9LG2B-025042	1"	25,0	38,1	46,4

Dimensions shown may be changed without prior notice

// TYPE S CLAW COUPLING (AUSTRALIAN TYPE)**// TYPE S CLAW COUPLING (AUSTRALIAN TYPE)****Hose shank with safety collar complete with seal - Plated steel**

Item Code	Product Code	Hose ID		Claw Distance Internal	Claw Distance External
		in	mm	mm	mm
2303057	I919N300-010045	3/8"	10,0	45	68
2302931	I919N300-013045	1/2"	13,0	45	68
2302932	I919N300-019045	3/4"	19,0	45	68
2302933	I919N300-025045	1"	25,0	45	68
2302934	I919N300-032045	1 1/4"	32,0	45	68
2302935	I919N300-038074	1 1/2"	38,0	74	115
2302936	I919N300-051074	2"	51,0	74	115
2302937	I919N300-076117	3"	76,0	117	174

// TYPE S CLAW COUPLING (AUSTRALIAN TYPE)**BSPT Male complete with seal - Plated steel**

Item Code	Product Code	Head DN side 1	Head DN side 1	Claw Distance Internal side 1	Claw Distance External side 1	Technical Note side 1	Thread type 2	Thread 2
		in	mm	mm	mm			in
2303058	I9A9N207-045017	-	45,0	45	68	-	BSPT	3/8"
2302938	I9A9N207-045021	-	45,0	45	68	-	BSPT	1/2"
2302939	I9A9N207-045027	-	45,0	45	68	-	BSPT	3/4"
2302940	I9A9N207-045034	-	45,0	45	68	-	BSPT	1"
2302941	I9A9N207-045042	-	45,0	45	68	-	BSPT	1"1/4
2302942	I9A9N207-074049	-	74,0	74	115	-	BSPT	1"1/2
2302943	I9A9N207-074060	-	74,0	74	115	-	BSPT	2"
2302944	I9A9N207-117090	-	117,0	117	174	-	BSPT	3"

// TYPE S CLAW COUPLING (AUSTRALIAN TYPE)**BSPP Female complete with seal - Plated steel**

Item Code	Product Code	Head DN side 1	Head DN side 1	Claw Distance Internal side 1	Claw Distance External side 1	Technical Note side 1	Thread type 2	Thread 2
		in	mm	mm	mm			in
2303059	I9A9N306-045017	-	45,0	45	68	-	BSPP	3/8"
2302945	I9A9N306-045021	-	45,0	45	68	-	BSPP	1/2"
2302946	I9A9N306-045027	-	45,0	45	68	-	BSPP	3/4"
2302947	I9A9N306-045034	-	45,0	45	68	-	BSPP	1"
2302948	I9A9N306-045042	-	45,0	45	68	-	BSPP	1"1/4
2302949	I9A9N306-074049	-	74,0	74	115	-	BSPP	1"1/2
2302950	I9A9N306-074060	-	74,0	74	115	-	BSPP	2"
2302951	I9A9N306-117090	-	117,0	117	174	-	BSPP	3"

// TYPE S CLAW COUPLING (AUSTRALIAN TYPE)**Three way connector complete with seal - Plated steel**

Item Code	Product Code	Head DN side 1	Head DN side 1	Claw Distance Internal side 1	Claw Distance External side 1	Technical Note side 1
		in	mm	mm	mm	
2303060	I9Y9N001	-	45,0	45	68	-
2303061	I9Y9N002	-	74,0	74	115	-

// TYPE S CLAW COUPLING (AUSTRALIAN TYPE)**Seal - NBR**

Item Code	Product Code	DN	DN
		mm	in
2303085	INJM9N-045	45	1 3/4"
2303086	INJM9N-074	74	3"
2306583	INJM9N-117	117	-

Dimensions shown may be changed without prior notice

// HOSE MENDER**// HOSE MENDER****Hose shank with safety collar for claw clamps - Plated steel**

Item Code	Product Code	Hose ID	Hose ID
		in	mm
2303062	I1156100-013013	1/2"	13,0
2303063	I1156100-019019	3/4"	19,0
2303064	I1156100-025025	1"	25,0
2303065	I1156100-038038	1 1/2"	38,0
2303066	I1156100-051051	2"	51,0

// HOSE MENDER DIN 20038**Hose shank without safety collar - Plated steel**

Item Code	Product Code	Hose ID	Hose ID
		in	mm
2305004	I165610D-010010	3/8"	10,0
2305001	I165610D-013013	1/2"	13,0
2305005	I165610D-016016	5/8"	16,0
2305003	I165610D-019019	3/4"	19,0
2305000	I165610D-025025	1"	25,0
2304999	I165610D-032032	1 1/4"	32,0
2304998	I165610D-038038	1 1/2"	38,0
2305002	I165610D-051051	2"	51,0

To assemble the hose menders, use "Double bolt clamp with two saddles - DIN 20039 A": consult chapter "Clamps"

// CLAW COUPLING - ACCESSORY

// SAFETY PIN

Safety Pin - AU type (A-Europe / B-U.S.A. / S-Australia) - Plated steel



Item Code	Product Code	DN	DN (min)	DN (max)	Technical Note
		in	mm	mm	
2303084	I1Y9N003	-	-	-	-

// SAFETY PIN

Safety Pin - standard type (A-Europe / B-U.S.A. / S-Australia) - Plated steel



Item Code	Product Code	DN	DN (min)	DN (max)	Technical Note
		in	mm	mm	
2303232	I1YC4001	-	-	-	-

Dimensions shown may be changed without prior notice

// CLAW COUPLING - CLAMP & FERRULE

// CLAW COUPLING

Claw clamp (A-Europe complete with safety pin holes / S-Australia) - Plated steel

Item Code	Product Code	Hose ID	Hose ID	Hose OD (min)	Hose OD (max)
		in	mm	mm	mm
2303069	I1LG2M-013022	1/2"	13,0	19,0	24,0
2303071	I1LG2M-013026	1/2"	13,0	22,0	28,0
2303072	I1LG2M-019030	3/4"	19,0	29,0	31,0
2303070	I1LG2M-025034	1"	25,0	31,0	36,0
2303073	I1LG2M-025038	1"	25,0	35,0	40,0

// CLAW COUPLING

Claw clamp with safety chain lugs (S-Australia) - Plated steel

Item Code	Product Code	Hose ID	Hose ID	Hose OD (min)	Hose OD (max)
		in	mm	mm	mm
2303074	I1LG2M-038052	1 1/2"	38,0	50,0	54,0
2303075	I1LG2M-051065	2"	51,0	63,0	67,0

// CLAW COUPLING

Claw clamp complete with safety chain (S-Australia) - Plated steel

Item Code	Product Code	Hose ID	Hose ID	Hose OD (min)	Hose OD (max)
		in	mm	mm	mm
2303076	I1LG2M-051Z65	2"	51,0	63,0	67,0

For Australian market, available also "Safety chain with shackles - length=450mm - Plated steel" (product Code I1LG2MSC-0450)

// I101U-AIR**Serrated ferrule (A-Europe complete with safety pin holes / S-Australia) - Plated steel**

Item Code	Product Code	Hose ID	Hose ID	Hose OD (min)	Hose OD (max)
		in	mm	mm	mm
2303078	I101U013-020023	1/2"	13,0	20,0	23,0
2303080	I101U025-034038	1"	25,0	34,0	38,0
2303081	I101U032-044048	1 1/4"	32,0	44,0	48,0

// I101U-AIR-S**Serrated ferrule (S-Australia) - Plated steel**

Item Code	Product Code	Hose ID	Hose ID	Hose OD (min)	Hose OD (max)
		in	mm	mm	mm
2303082	I101U038-048054	1 1/2"	38,0	48,0	54,0
2303083	I101U051-062067	2"	51,0	62,0	67,0



// WATER

// TYPE GK CLAW COUPLING.....	166
// TYPE B - BAUER COMPATIBLE.....	168
// TYPE C - CARDAN/PERROT COMPATIBLE.....	173
// VIDANGE.....	174
// TYPE 42.....	175
// SHOULDERED STYLE.....	178

// TYPE GK CLAW COUPLING

// TYPE GK CLAW COUPLING

Hose shank complete with seal - Brass



Item Code	Product Code	Hose ID	Hose ID	Claw Distance Internal	Claw Distance External
		in	mm	mm	mm
2304856	I818A300-010040	3/8"	10,0	40	54
2301796	I818A300-013040	1/2"	13,0	40	54
2304857	I818A300-016040	5/8"	16,0	40	54
2301797	I818A300-019040	3/4"	19,0	40	54
2301798	I818A300-025040	1"	25,0	40	54
2304859	I818A300-032040	1 1/4"	32,0	40	54
2304858	I818A300-038040	1 1/2"	38,0	40	54

To assemble the insert with "R5YBFF0" crimping ring, consult chapter "Ferrule & crimping ring"

// TYPE GK CLAW COUPLING

BSPP Male complete with seal - Brass



Item Code	Product Code	Head DN side 1	Head DN side 1	Claw Distance Internal side 1	Claw Distance External side 1	Technical Note side 1	Thread type 2	Thread 2
		in	mm	mm	mm			in
2305651	I8A8A206-040017	-	40,0	40	54	-	BSPP	3/8"
2305648	I8A8A206-040021	-	40,0	40	54	-	BSPP	1/2"
2305650	I8A8A206-040027	-	40,0	40	54	-	BSPP	3/4"
2305647	I8A8A206-040034	-	40,0	40	54	-	BSPP	1"
2305652	I8A8A206-040042	-	40,0	40	54	-	BSPP	1 1/4"

// TYPE GK CLAW COUPLING

BSPP Female complete with seal - Brass



Item Code	Product Code	Head DN side 1	Head DN side 1	Claw Distance Internal side 1	Claw Distance External side 1	Technical Note side 1	Thread type 2	Thread 2
		in	mm	mm	mm			in
2305658	I8A8A306-040017	-	40,0	40	54	-	BSPP	3/8"
2305654	I8A8A306-040021	-	40,0	40	54	-	BSPP	1/2"
2305657	I8A8A306-040027	-	40,0	40	54	-	BSPP	3/4"
2305653	I8A8A306-040034	-	40,0	40	54	-	BSPP	1"
2305659	I8A8A306-040042	-	40,0	40	54	-	BSPP	1 1/4"

Dimensions shown may be changed without prior notice

// TYPE GK CLAW COUPLING**Blank cap complete with seal - Brass**

Item Code	Product Code	Head DN	Head DN	Claw Distance	Claw Distance	Technical Note
		side 1	side 1	Internal side 1	External side 1	
		in	mm	mm	mm	side 1
2305660	I8A8A400-040000	-	40,0	40	54	-

// TYPE GK CLAW COUPLING**Seal - NBR**

Item Code	Product Code	DN	DN
		mm	in
2304440	INJM8A-040	40	1 9/16"

// TYPE B - BAUER COMPATIBLE**// TYPE B - BAUER COMPATIBLE****Male with closure lever - Hose shank - Plated steel**

Item Code	Product Code	Hose ID		Head DN mm
		in	mm	
2301799	I119B100-050050	2"	50,0	50,0
2302221	I119B100-076076	3"	76,0	76,0
2301800	I119B100-076089	3"	76,0	89,0
2301801	I119B100-102108	4"	102,0	108,0
2302268	I119B100-125133	5"	125,0	133,0
2301802	I119B100-152159	6"	152,0	159,0
2302269	I119B100-203194	8"	203,0	194,0

// TYPE B - BAUER COMPATIBLE**Male without closure lever - Heavy duty hose shank - Plated steel**

Item Code	Product Code	Hose ID		Head DN mm
		in	mm	
2303113	I11SB10H-102108	4"	102,0	108,0
2303114	I11SB10H-152159	6"	152,0	159,0
2303115	I11SB10H-203194	8"	203,0	194,0

// TYPE B - BAUER COMPATIBLE**Closure lever - Plated steel**

Item Code	Product Code	DN	DN (min)	DN (max)	Technical Note
		in	mm	mm	
2303127	I1Y9B050	-	50	50	-
2303128	I1Y9B076	-	76	76	-
2303129	I1Y9B089	-	89	89	-
2303130	I1Y9B108	-	108	108	-
2305904	I1Y9B133	-	133	133	-
2303131	I1Y9B159	-	159	159	-
2303132	I1Y9B194	-	194	194	-

Dimensions shown may be changed without prior notice

// TYPE B - BAUER COMPATIBLE**Female - Hose shank complete with seal - Plated steel**

Item Code	Product Code	Hose ID		Head DN
		in	mm	mm
2301803	I119B200-050050	2"	50,0	50,0
2302222	I119B200-076076	3"	76,0	76,0
2301804	I119B200-076089	3"	76,0	89,0
2301805	I119B200-102108	4"	102,0	108,0
2302270	I119B200-125133	5"	125,0	133,0
2301806	I119B200-152159	6"	152,0	159,0
2302271	I119B200-203194	8"	203,0	194,0

// TYPE B - BAUER COMPATIBLE**Female - Heavy duty hose shank - without seal - Plated steel**

Item Code	Product Code	Hose ID		Head DN
		in	mm	mm
2303120	I119B20H-102108	4"	102,0	108,0
2303121	I119B20H-152159	6"	152,0	159,0
2303122	I119B20H-203194	8"	203,0	194,0

// TYPE B - BAUER COMPATIBLE**Male without closure lever - Black weld on - Unplated steel**

Item Code	Product Code	Thread type 1	Head DN side 1		Thread type 2	Head DN side 2	
			in	mm		in	mm
2303095	I0BSB100-089	BAUER	-	89,0	@N/A	-	89,0
2303096	I0BSB100-108	BAUER	-	108,0	@N/A	-	108,0
2303097	I0BSB100-159	BAUER	-	159,0	@N/A	-	159,0
2303098	I0BSB100-194	BAUER	-	194,0	@N/A	-	194,0

// TYPE B - BAUER COMPATIBLE**Female complete with seal - Black weld on - Unplated steel**

Item Code	Product Code	Thread type 1	Head DN side 1	Head DN side 1	Thread type 2	Head DN side 2	Head DN side 2
			in	mm		in	mm
2303087	I0B9B200-089	BAUER	-	89,0	@N/A	-	89,0
2303088	I0B9B200-108	BAUER	-	108,0	@N/A	-	108,0
2303089	I0B9B200-159	BAUER	-	159,0	@N/A	-	159,0
2303090	I0B9B200-194	BAUER	-	194,0	@N/A	-	194,0

// TYPE B - BAUER COMPATIBLE**Male with closure lever - BSPT Male - Plated steel**

Item Code	Product Code	Thread type 1	Head DN side 1	Head DN side 1	Thread 1	Thread type 2	Head DN side 2	Head DN side 2	Thread 2
			in	mm			in	in	
2307546	I1A9B507-050060	BAUER	-	50,0	-	BSPT	2"	51,0	2"
2305934	I1A9B507-076090	BAUER	-	76,0	-	BSPT	3"	76,0	3"
2305935	I1A9B507-089090	BAUER	-	89,0	-	BSPT	3"	76,0	3"
2305937	I1A9B507-108114	BAUER	-	108,0	-	BSPT	4"	102,0	4"
2305938	I1A9B507-133140	BAUER	-	133,0	-	BSPT	5"	127,0	5"
2305939	I1A9B507-159165	BAUER	-	159,0	-	BSPT	6"	152,0	6"
2307704	I1A9B507-194219	BAUER	-	194,0	-	BSPT	8"	219,0	8"

// TYPE B - BAUER COMPATIBLE**Female complete with seal - BSPT Male - Plated steel**

Item Code	Product Code	Thread type 1	Head DN side 1	Head DN side 1	Thread 1	Thread type 2	Head DN side 2	Head DN side 2	Thread 2
			in	mm			in	in	
2303133	I1A9B007-050060	BAUER	-	50,0	-	BSPT	2"	51,0	2"
2303134	I1A9B007-076090	BAUER	-	76,0	-	BSPT	3"	76,0	3"
2303135	I1A9B007-089090	BAUER	-	89,0	-	BSPT	3"	76,0	3"
2303136	I1A9B007-108114	BAUER	-	108,0	-	BSPT	4"	102,0	4"
2303137	I1A9B007-159165	BAUER	-	159,0	-	BSPT	6"	152,0	6"
2303138	I1A9B007-194219	BAUER	-	194,0	-	BSPT	8"	203,0	8"

Dimensions shown may be changed without prior notice

// TYPE B - BAUER COMPATIBLE**Male with closure lever - BS10 Table D fixed flange - Plated steel**

Item Code	Product Code	Thread type 1	Head DN side 1	Head DN side 1	Thread type 2	Head DN side 2	Head DN side 2
			in	mm		in	mm
2303145	I1ABZ29B-102108	BAUER	-	108,0	BS10-D	4"	100,0
2303146	I1ABZ29B-152159	BAUER	-	159,0	BS10-D	6"	150,0
2303147	I1ABZ29B-203194	BAUER	-	194,0	BS10-D	8"	200,0

// TYPE B - BAUER COMPATIBLE**Female complete with seal - BS10 Table D fixed flange - Plated steel**

Item Code	Product Code	Thread type 1	Head DN side 1	Head DN side 1	Thread type 2	Head DN side 2	Head DN side 2
			in	mm		in	mm
2303148	I1ABZ39B-102108	BAUER	-	108,0	BS10-D	4"	100,0
2303149	I1ABZ39B-152159	BAUER	-	159,0	BS10-D	6"	150,0
2303150	I1ABZ39B-203194	BAUER	-	194,0	BS10-D	8"	200,0

// TYPE B - BAUER COMPATIBLE**Seal - SBR**

Item Code	Product Code	DN	DN
		mm	in
2302959	ISJM9B-050	50	2"
2302960	ISJM9B-076	76	3"
2302961	ISJM9B-089	89	3 1/2"
2302962	ISJM9B-108	108	4 1/4"
2302963	ISJM9B-133	133	5 1/4"
2302964	ISJM9B-159	159	6 1/4"
2302965	ISJM9B-194	194	7 5/8"

// TYPE B - BAUER COMPATIBLE**Antioil Rubber Seal - NBR**

Item Code	Product Code	DN	DN
		mm	in
2302869	INJM9B-050	50	2"
2302870	INJM9B-076	76	3"
2302871	INJM9B-089	89	3 1/2"
2302872	INJM9B-108	108	4 1/4"
2302873	INJM9B-133	133	5 1/4"
2302874	INJM9B-159	159	6 1/4"
2302875	INJM9B-194	194	7 5/8"

Dimensions shown may be changed without prior notice

// TYPE C - CARDAN/PERROT COMPATIBLE**// TYPE C - CARDAN/PERROT COMPATIBLE****Male - Hose shank - Plated steel**

Item Code	Product Code	Hose ID	Hose ID	Head DN
		in	mm	mm
2302272	I119P100-050050	2"	50,0	50,0
2306770	I119P100-063070	2 1/2"	63,0	70,0
2302273	I119P100-076070	3"	76,0	70,0
2306072	I119P100-076089	3"	76,0	89,0
2301791	I119P100-102108	4"	102,0	108,0
2301792	I119P100-125133	5"	125,0	133,0
2302275	I119P100-152159	6"	152,0	159,0

// TYPE C - CARDAN/PERROT COMPATIBLE**Female with closure lever - Hose shank complete with seal - Plated steel**

Item Code	Product Code	Hose ID	Hose ID	Head DN
		in	mm	mm
2302276	I119P200-050050	2"	50,0	50,0
2306771	I119P200-063070	2 1/2"	63,0	70,0
2302277	I119P200-076070	3"	76,0	70,0
2306071	I119P200-076089	3"	76,0	89,0
2306128	I119P200-090089	3 1/2"	90,0	89,0
2301793	I119P200-102108	4"	102,0	108,0
2301794	I119P200-125133	5"	125,0	133,0
2302279	I119P200-152159	6"	152,0	159,0

// VIDANGE

// VIDANGE

Male - Hose shank - Brass



Item Code	Product Code	Hose ID	Hose ID	Head DN
		in	mm	mm
2301558	I819A100-105100	4 1/8"	105,0	100,0

// VIDANGE

Female complete with seal - Hose shank - Brass



Item Code	Product Code	Hose ID	Hose ID	Head DN
		in	mm	mm
2301557	I819A200-105100	4 1/8"	105,0	100,0

Dimensions shown may be changed without prior notice

// TYPE 42

// TYPE 42

Male - Hose shank - Plated steel



Item Code	Product Code	Hose ID	Hose ID	Head DN	Head DN
		in	mm	in	mm
2305186	-	2"	51,0	-	48,0
2304741	-	2"	51,0	-	76,0
2305275	-	2 1/2"	63,0	-	76,0
2305187	-	3"	76,0	-	76,0
2304736	-	3"	76,0	-	102,0
2305188	-	4"	102,0	-	102,0
2305189	-	5"	127,0	-	133,0
2305190	-	6"	152,0	-	152,0

// TYPE 42

Female with closure lever complete with seal - Hose shank - Plated steel



Item Code	Product Code	Hose ID	Hose ID	Head DN	Head DN
		in	mm	in	mm
2305199	-	2"	51,0	-	48,0
2304749	-	2"	51,0	-	76,0
2305278	-	2 1/2"	63,0	-	76,0
2305200	-	3"	76,0	-	76,0
2305576	-	3"	76,0	-	102,0
2305201	-	4"	102,0	-	102,0
2305202	-	5"	127,0	-	133,0
2305203	-	6"	152,0	-	152,0

// TYPE 42

Male - Weld on - Plated steel



Item Code	Product Code	Thread type 1	Head DN side 1	Head DN side 1	Thread type 2	Head DN side 2	Head DN side 2
			in	mm		in	mm
2305569	-	TYPE42	-	48,0	@N/A	-	51,0
2305180	-	TYPE42	-	76,0	@N/A	-	76,0
2305181	-	TYPE42	-	102,0	@N/A	-	102,0
2304737	-	TYPE42	-	133,0	@N/A	-	133,0
2305272	-	TYPE42	-	152,0	@N/A	-	152,0

// TYPE 42

Female with closure lever complete with seal - Weld on - Plated steel



Item Code	Product Code	Thread type 1	Head DN side 1	Head DN side 1	Thread type 2	Head DN side 2	Head DN side 2
			in	mm		in	mm
2305193	-	TYPE42	-	76,0	@N/A	-	76,0
2305194	-	TYPE42	-	102,0	@N/A	-	102,0

// TYPE 42

Male - BSPT Male - Plated steel



Item Code	Product Code	Thread type 1	Head DN side 1	Head DN side 1	Thread 1	Thread type 2	Head DN side 2	Head DN side 2	Thread 2
			in	mm	in		in	mm	in
2305183	-	TYPE42	-	48,0	-	BSPT	2"	51,0	2"
2304739	-	TYPE42	-	76,0	-	BSPT	3"	76,0	3"
2305273	-	TYPE42	-	102,0	-	BSPT	4"	102,0	4"

// TYPE 42

Female with closure lever complete with seal - BSPT Male - Plated steel



Item Code	Product Code	Thread type 1	Head DN side 1	Head DN side 1	Thread 1	Thread type 2	Head DN side 2	Head DN side 2	Thread 2
			in	mm	in		in	mm	in
2305196	-	TYPE42	-	48,0	-	BSPT	2"	51,0	2"
2304747	-	TYPE42	-	76,0	-	BSPT	3"	76,0	3"
2305277	-	TYPE42	-	102,0	-	BSPT	4"	102,0	4"

Dimensions shown may be changed without prior notice

// TYPE 42

Male plug - Plated steel



Item Code	Product Code	Thread type 1	Head DN side 1	Head DN side 1	Thread 1
			in	mm	in
2305573	-	TYPE42	-	48,0	-
2304742	-	TYPE42	-	76,0	-
2304743	-	TYPE42	-	102,0	-

// TYPE 42

Female cap with closure lever complete with seal - Plated steel



Item Code	Product Code	Thread type 1	Head DN side 1	Head DN side 1	Thread 1
			in	mm	in
2304750	-	TYPE42	-	48,0	-
2304751	-	TYPE42	-	76,0	-
2304752	-	TYPE42	-	102,0	-
2305571	-	TYPE42	-	133,0	-

// TYPE 42

Seal - NBR



Item Code	Product Code	DN	DN
		mm	in
2304423	-	48	1 7/8"
2304424	-	76	3"
2304425	-	102	4"
2305589	-	133	5 1/4"
2304426	-	152	6"

// TYPE 42

Seal - EPDM



Item Code	Product Code	DN	DN
		mm	in
2305588	-	48	1 7/8"
2304419	-	76	3"
2304420	-	102	4"
2304421	-	133	5 1/4"
2304422	-	152	6"

// SHOULDERED STYLE**// SHOULDERED STYLE****Low Pressure - Serrated hose shank complete with pre-crimped ferrule - Plated steel**

Item Code	Product Code	Hose ID	Hose ID	Head DN	Head DN	A	B	C	D	Hose OD (min)	Hose OD (max)
		in	mm	in	mm	mm	mm	mm	mm	mm	mm
2306883	I179RL00-076097	3"	76,0	3"	97,0	97,0	88,5	16,0	20,0	88,0	102,0
2306884	I179RL00-102122	4"	102,0	4"	122,0	122,0	115,0	17,5	20,0	114,0	128,0
2307046	I179RL00-152175	6"	152,0	6"	174,5	174,5	165,1	17,5	20,0	166,0	184,0



// HYGIENIC - FOOD

// SMS 1145	180
// DIN 11851	181
// MACON	183
// HYGIENIC COUPLING - FERRULE	183

// SMS 1145**// SMS 1145****Male - Serrated hose shank with collar - complete with seal - Stainless steel 316**

Item Code	Product Code	Hose ID	Hose ID	Thread type	Thread
		in	mm		in
2301811	I389S100-025025	1"	25,0	SMS	40 x 1/6"
2301812	I389S100-038040	1 1/2"	38,0	SMS	60 x 1/6"
2301611	I389S100-051050	2"	51,0	SMS	70 x 1/6"
2301638	I389S100-063065	2 1/2"	63,0	SMS	85 x 1/6"
2301737	I389S100-076080	3"	76,0	SMS	98 x 1/6"
2302567	I389S100-102100	4"	102,0	SMS	132 x 1/6"

// SMS 1145**Female - Serrated hose shank with collar - Stainless steel 316**

Item Code	Product Code	Hose ID	Hose ID	Thread type	Thread
		in	mm		in
2301612	I389S200-025025	1"	25,0	SMS	40 x 1/6"
2301813	I389S200-038040	1 1/2"	38,0	SMS	60 x 1/6"
2301276	I389S200-051050	2"	51,0	SMS	70 x 1/6"
2301637	I389S200-063065	2 1/2"	63,0	SMS	85 x 1/6"
2301814	I389S200-076080	3"	76,0	SMS	98 x 1/6"
2302568	I389S200-102100	4"	102,0	SMS	132 x 1/6"

Dimensions shown may be changed without prior notice

// DIN 11851

// DIN 11851

Male - EN 14 420-2 / DIN 2817 hose shank complete with seal - Stainless steel 316

Item Code	Product Code	Hose ID	Hose ID	Thread type	Thread
		in	mm		in
2302529	I349Q100-025025	1"	25,0	DIN11851	52 x 1/6"
2302530	I349Q100-032032	1 1/4"	32,0	DIN11851	58 x 1/6"
2302531	I349Q100-038040	1 1/2"	38,0	DIN11851	65 x 1/6"
2302532	I349Q100-051050	2"	50,0	DIN11851	78 x 1/6"
2302533	I349Q100-063065	2 9/16"	65,0	DIN11851	95 x 1/6"
2302534	I349Q100-076080	3"	75,0	DIN11851	110 x 1/4"
2302535	I349Q100-102100	4"	100,0	DIN11851	130 x 1/4"

To assemble the insert, use "Safety clamps EN 14 420-3 / DIN 2817" and "Safety clamps Flexoline®": consult chapter "Clamps"

// DIN 11851

Female - EN 14 420-2 / DIN 2817 hose shank - Stainless steel 316

Item Code	Product Code	Hose ID	Hose ID	Thread type	Thread
		in	mm		in
2302536	I349Q200-025025	1"	25,0	DIN11851	52 x 1/6"
2302537	I349Q200-032032	1 1/4"	32,0	DIN11851	58 x 1/6"
2302538	I349Q200-038040	1 1/2"	38,0	DIN11851	65 x 1/6"
2302539	I349Q200-051050	2"	50,0	DIN11851	78 x 1/6"
2302540	I349Q200-063065	2 9/16"	65,0	DIN11851	95 x 1/6"
2302541	I349Q200-076080	3"	75,0	DIN11851	110 x 1/4"
2302542	I349Q200-102100	4"	100,0	DIN11851	130 x 1/4"

To assemble the insert, use "Safety clamps EN 14 420-3 / DIN 2817" and "Safety clamps Flexoline®": consult chapter "Clamps"

// DIN 11851

Male - Serrated hose shank complete with seal - Stainless steel 316

Item Code	Product Code	Hose ID	Hose ID	Thread type	Thread
		in	mm		in
2302561	I389Q100-025025	1"	25,0	DIN11851	52 x 1/6"
2302562	I389Q100-032032	1 1/4"	32,0	DIN11851	58 x 1/6"
2302563	I389Q100-038040	1 1/2"	38,0	DIN11851	65 x 1/6"
2301713	I389Q100-051050	2"	51,0	DIN11851	78 x 1/6"
2301642	I389Q100-063065	2 1/2"	63,0	DIN11851	95 x 1/6"
2301643	I389Q100-076080	3"	76,0	DIN11851	110 x 1/4"
2302564	I389Q100-102100	4"	102,0	DIN11851	130 x 1/4"

// DIN 11851

Female with round nut - Serrated hose shank - Stainless steel 316

Item Code	Product Code	Hose ID	Hose ID	Thread type	Thread
		in	mm		in
2301816	I389Q200-025025	1"	25,0	DIN11851	52 x 1/6"
2302565	I389Q200-032032	1 1/4"	32,0	DIN11851	58 x 1/6"
2301741	I389Q200-038040	1 1/2"	38,0	DIN11851	65 x 1/6"
2301639	I389Q200-051050	2"	51,0	DIN11851	78 x 1/6"
2301640	I389Q200-063065	2 1/2"	63,0	DIN11851	95 x 1/6"
2301641	I389Q200-076080	3"	76,0	DIN11851	110 x 1/4"
2302566	I389Q200-102100	4"	102,0	DIN11851	130 x 1/4"

Dimensions shown may be changed without prior notice

// MACON

// MACON

Male - Serrated hose shank with collar - Stainless steel 316



Item Code	Product Code	Hose ID	Hose ID	Head DN
		in	mm	mm
2301635	I389M100-040040	1 9/16"	40,0	40,0
2301636	I389M100-050050	2"	50,0	50,0
2301817	I389M100-070070	2 3/4"	70,0	70,0

// MACON

Female with round nut - Serrated hose shank with collar complete with seal - Stainless steel 316



Item Code	Product Code	Hose ID	Hose ID	Head DN
		in	mm	mm
2301633	I389M200-040040	1 9/16"	40,0	40,0
2301634	I389M200-050050	2"	50,0	50,0
2301818	I389M200-070070	2 3/4"	70,0	70,0

// HYGIENIC COUPLING - FERRULE

// I208U

Serrated ferrule - for hygienic coupling - Stainless steel 304



Item Code	Product Code	Hose ID	Hose ID	Hose OD (min)	Hose OD (max)
		in	mm	mm	mm
2307467	I208U025-033038	1"	25,0	33,0	38,0
2307466	I208U032-042046	1 1/4"	32,0	42,0	46,0
2301526	I208U040-047053	1 9/16"	40,0	47,0	53,0
2301527	I208U051-060065	2"	51,0	60,0	65,0
2301528	I208U063-074078	2 1/2"	63,0	74,0	78,0
2301529	I208U070-081086	2 3/4"	70,0	81,0	86,0
2301530	I208U076-087092	3"	76,0	87,0	92,0

For serrated ferrules in S/S316, see "I307U-RK": consult chapter "Ferrule & crimping ring"



// STEAM

// EN 14 423 / DIN 2826	185
// GROUND JOINT SEAL.....	188
// TURNEX P.....	190

Dimensions shown may be changed without prior notice

// EN 14 423 / DIN 2826**// EN 14 423 / DIN 2826****BSPT Male - Hose shank EN 14 423 / DIN 2826 - Brass**

Item Code	Product Code	Hose ID	Hose ID	Thread type	Thread
		in	mm		in
2302755	I8107100-013021	1/2"	13,0	BSPT	1/2"
2302218	I8107100-019027	3/4"	19,0	BSPT	3/4"
2301718	I8107100-025034	1"	25,0	BSPT	1"
2301819	I8107100-038049	1 1/2"	38,0	BSPT	1"1/2
2301820	I8107100-051060	2"	51,0	BSPT	2"

// EN 14 423 / DIN 2826**BSPT Male - Hose shank EN 14 423 / DIN 2826 - Stainless steel 316**

Item Code	Product Code	Hose ID	Hose ID	Thread type	Thread
		in	mm		in
2302433	I3107100-013021	1/2"	13,0	BSPT	1/2"
2302434	I3107100-019027	3/4"	19,0	BSPT	3/4"
2302435	I3107100-025034	1"	25,0	BSPT	1"
2302436	I3107100-038049	1 1/2"	38,0	BSPT	1"1/2
2302437	I3107100-051060	2"	51,0	BSPT	2"

// EN 14 423 / DIN 2826**BSPP Female - Hose shank EN 14 423 / DIN 2826 - Brass**

Item Code	Product Code	Hose ID	Hose ID	Thread type	Thread
		in	mm		in
2302754	I8106200-013021	1/2"	13,0	BSPP	1/2"
2301821	I8106200-019027	3/4"	19,0	BSPP	3/4"
2301822	I8106200-025034	1"	25,0	BSPP	1"
2301823	I8106200-038049	1 1/2"	38,0	BSPP	1 1/2"
2301824	I8106200-051060	2"	51,0	BSPP	2"

// EN 14 423 / DIN 2826**BSPP Female - Hose shank EN 14 423 / DIN 2826 - Stainless steel 316**

Item Code	Product Code	Hose ID	Hose ID	Thread type	Thread
		in	mm		in
2302428	I3106200-013021	1/2"	13,0	BSPP	1/2"
2302429	I3106200-019027	3/4"	19,0	BSPP	3/4"
2302430	I3106200-025034	1"	25,0	BSPP	1"
2302431	I3106200-038049	1 1/2"	38,0	BSPP	1 1/2"
2302432	I3106200-051060	2"	51,0	BSPP	2"

Dimensions shown may be changed without prior notice

// EN 14 423 / DIN 2826**PN40 swivel flange - Hose shank EN 14 423 / DIN 2826 - Plated steel**

Item Code	Product Code	Hose ID	Hose ID	Thread type	Head DN	Head DN
		in	mm		in	mm
2302371	I17BG74A-019020	3/4"	19,0	PN40	3/4"	20,0
2302372	I17BG74A-025025	1"	25,0	PN40	1"	25,0
2302373	I17BG74A-038040	1 1/2"	38,0	PN40	1 1/2"	40,0
2302374	I17BG74A-051050	2"	51,0	PN40	2"	50,0

// EN 14 423 / DIN 2826**PN40 swivel flange - Hose shank EN 14 423 / DIN 2826 - Stainless steel 316**

Item Code	Product Code	Hose ID	Hose ID	Thread type	Head DN	Head DN
		in	mm		in	mm
2302555	I37BG74A-019020	3/4"	19,0	PN40	3/4"	20,0
2302556	I37BG74A-025025	1"	25,0	PN40	1"	25,0
2302557	I37BG74A-038040	1 1/2"	38,0	PN40	1 1/2"	40,0
2302558	I37BG74A-051050	2"	51,0	PN40	2"	50,0

// EN 14 423 / DIN 2826**Safety clamps - Brass**

Item Code	Product Code	Hose ID	Hose ID	Hose OD (min)	Hose OD (max)
		in	mm	mm	mm
2302810	I8LG4C-013025	1/2"	13,0	24,0	26,0
2302223	I8LG4C-019033	3/4"	19,0	32,0	34,0
2302811	I8LG4C-025040	1"	25,0	39,0	41,0
2302812	I8LG4C-038054	1 1/2"	38,0	53,0	56,0
2302813	I8LG4C-050068	2"	51,0	67,0	69,0

// GROUND JOINT SEAL**// GROUND JOINT SEAL****BSPT Male - Serrated hose shank with safety collar - Plated steel**

Item Code	Product Code	Hose ID	Hose ID	Thread type	Thread
		in	mm		in
2302983	I118B107-013021	1/2"	13,0	BSPT	1/2"
2302984	I118B107-019027	3/4"	19,0	BSPT	3/4"
2302985	I118B107-025034	1"	25,0	BSPT	1"

// GROUND JOINT SEAL**BSPT Male - Serrated hose shank with safety collar - Malleable iron**

Item Code	Product Code	Hose ID	Hose ID	Thread type	Thread
		in	mm		in
2302986	I918B107-032042	1 1/4"	32,0	BSPT	1"1/4
2302987	I918B107-038049	1 1/2"	38,0	BSPT	1"1/2
2302988	I918B107-051060	2"	51,0	BSPT	2"
2302989	I918B107-063076	2 1/2"	63,0	BSPT	2"1/2
2302990	I918B107-076090	3"	76,0	BSPT	3"
2302991	I918B107-102114	4"	102,0	BSPT	4"

// GROUND JOINT SEAL**NPT Male - Serrated hose shank with safety collar - Malleable iron**

Item Code	Product Code	Hose ID	Hose ID	Thread type	Thread
		in	mm		in
2303428	I918B128-013021	1/2"	13,0	NPT	1/2"
2303429	I918B128-019027	3/4"	19,0	NPT	3/4"
2303430	I918B128-025034	1"	25,0	NPT	1"
2303431	I918B128-032042	1 1/4"	32,0	NPT	1"1/4
2303432	I918B128-038049	1 1/2"	38,0	NPT	1"1/2
2303433	I918B128-051060	2"	51,0	NPT	2"
2303434	I918B128-063076	2 1/2"	63,0	NPT	2"1/2
2303435	I918B128-076090	3"	76,0	NPT	3"
2303436	I918B128-102114	4"	102,0	NPT	4"

Dimensions shown may be changed without prior notice

// GROUND JOINT SEAL**BSPP Female complete with wing nut and seal - Serrated hose shank with collar - Malleable iron**

Item Code	Product Code	Hose ID	Hose ID	Thread type	Thread
		in	mm		in
2302966	I918B206-013021	1/2"	13,0	BSPP	1/2"
2302967	I918B206-019027	3/4"	19,0	BSPP	3/4"
2302968	I918B206-025034	1"	25,0	BSPP	1"
2302969	I918B206-032042	1 1/4"	32,0	BSPP	1"1/4
2302970	I918B206-038049	1 1/2"	38,0	BSPP	1"1/2
2302971	I918B206-051060	2"	51,0	BSPP	2"
2302972	I918B206-063076	2 1/2"	63,0	BSPP	2"1/2
2302973	I918B206-076090	3"	76,0	BSPP	3"
2302974	I918B206-102114	4"	102,0	BSPP	4"

// GROUND JOINT SEAL**NPT Female complete with wing nut and seal - Serrated hose shank with collar - Malleable iron**

Item Code	Product Code	Hose ID	Hose ID	Thread type	Thread
		in	mm		in
2303386	I918B228-013021	1/2"	13,0	NPT	1/2"
2303387	I918B228-019027	3/4"	19,0	NPT	3/4"
2303388	I918B228-025034	1"	25,0	NPT	1"
2303389	I918B228-032042	1 1/4"	32,0	NPT	1"1/4
2303390	I918B228-038049	1 1/2"	38,0	NPT	1"1/2
2303391	I918B228-051060	2"	51,0	NPT	2"
2303392	I918B228-063076	2 1/2"	63,0	NPT	2"1/2
2303393	I918B228-076090	3"	76,0	NPT	3"
2303394	I918B228-102114	4"	102,0	NPT	4"

// GROUND JOINT SEAL**Clamps - 2 bolt - 2 gripping finger type - Malleable iron**

Item Code	Product Code	Hose ID	Hose ID	Hose OD (min)	Hose OD (max)
		in	mm	mm	mm
2302992	I9LG2F-013026	1/2"	13,0	24,0	27,0
2302993	I9LG2F-019032	3/4"	19,0	30,0	33,0
2303440	I9LG2F-019036	3/4"	19,0	33,3	38,1

// GROUND JOINT SEAL**Clamps - 4 bolt - 2 gripping finger type - Malleable iron**

Item Code	Product Code	Hose ID	Hose ID	Hose OD (min)	Hose OD (max)
		in	mm	mm	mm
2303443	I9LG4F-025038	1"	25,0	35,7	39,7
2302994	I9LG4F-025041	1"	25,0	39,0	43,5
2302995	I9LG4F-032046	1 1/4"	32,0	43,0	47,5
2302996	I9LG4F-038049	1 1/2"	38,0	46,0	51,0
2307855	I9LG4F-038054	1 1/2"	38,0	51,0	56,0
2303448	I9LG4F-038060	1 1/2"	38,0	55,5	60,0
2302997	I9LG4F-051067	2"	51,0	63,0	70,0
2307547	I9LG4F-063083	2 1/2"	63,0	78,5	87,5
2302998	I9LG4F-076094	3"	76,0	89,0	100,0

// GROUND JOINT SEAL**Clamps - 6 bolt - 3 gripping finger type - Malleable iron**

Item Code	Product Code	Hose ID	Hose ID	Hose OD (min)	Hose OD (max)
		in	mm	mm	mm
2302999	I9LG6F-102123	4"	102,0	117,5	127,0
2307548	I9LG6F-102142	4"	102,0	133,5	142,0

// TURNEX P**// TURNEX P****Female with wing nut - Serrated hose shank with safety collar - Plated steel**

Item Code	Product Code	Hose ID	Hose ID	Thread type	Thread
		in	mm		in
2300617	I119X200-019027	3/4"	19,0	TURNEXP	3/4"
2302280	I119X200-025034	1"	25,0	TURNEXP	1"
2302281	I119X200-025049	1"	25,0	TURNEXP	1"1/2

To assemble the insert, use hydraulic Alfacrimp ferrule (H1200004-120000 and H1200004-160000). Consult ALFAGOMMA hydraulic catalogue.



// SYMMETRIC GUILLEMIN

// SYMMETRIC GUILLEMIN NF E 29.572 - HOSE SHANK.....	192
// SYMMETRIC GUILLEMIN NF E 29.572 - ADAPTER.....	194
// SYMMETRIC GUILLEMIN NF E 29.572 - SEAL & ACCESSORY	201

// SYMMETRIC GUILLEMIN NF E 29.572 - HOSE SHANK**// SYMMETRIC GUILLEMIN NF E 29.572****Serrated hose shank - with locking ring complete with seal - Aluminium**

Item Code	Product Code	Hose ID	Hose ID	Head DN
		in	mm	mm
2300648	I5191300-025020	1"	25,0	20,0
2300649	I5191300-030025	1 3/16"	30,0	25,0
2302106	I5191300-035032	1 3/8"	35,0	32,0
2300653	I5191300-045040	1 3/4"	45,0	40,0
2300655	I5191300-055050	2 1/8"	55,0	50,0
2300656	I5191300-070065	2 3/4"	70,0	65,0
2300658	I5191300-090080	3 1/2"	90,0	80,0
2300660	I5191300-110100	4 5/16"	110,0	100,0

// SYMMETRIC GUILLEMIN NF E 29.572**Serrated hose shank - with locking ring complete with seal - Stainless steel 316**

Item Code	Product Code	Hose ID	Hose ID	Head DN
		in	mm	mm
2302438	I3191300-025020	1"	25,0	20,0
2302439	I3191300-030025	1 3/16"	30,0	25,0
2302101	I3191300-035032	1 3/8"	35,0	32,0
2300624	I3191300-045040	1 3/4"	45,0	40,0
2300625	I3191300-055050	2 1/8"	55,0	50,0
2301044	I3191300-070065	2 3/4"	70,0	65,0
2300627	I3191300-090080	3 1/2"	90,0	80,0
2302442	I3191300-110100	4 5/16"	110,0	100,0

// SYMMETRIC GUILLEMIN NF E 29.572**Serrated hose shank - with locking ring complete with seal - Bronze**

Item Code	Product Code	Hose ID	Hose ID	Head DN
		in	mm	mm
2300679	I7191300-025020	1"	25,0	20,0
2300680	I7191300-030025	1 3/16"	30,0	25,0
2302111	I7191300-035032	1 3/8"	35,0	32,0
2300682	I7191300-045040	1 3/4"	45,0	40,0
2300684	I7191300-055050	2 1/8"	55,0	50,0
2300685	I7191300-070065	2 3/4"	70,0	65,0
2300687	I7191300-090080	3 1/2"	90,0	80,0
2300688	I7191300-110100	4 5/16"	110,0	100,0

Dimensions shown may be changed without prior notice

// SYMMETRIC GUILLEMIN NF E 29.572**Serrated hose shank with collar - with locking ring complete with seal - Aluminium**

Item Code	Product Code	Hose ID	Hose ID	Head DN
		in	mm	mm
2302105	I5191300-030032	1 3/16"	30,0	32,0
2300652	I5191300-040040	1 9/16"	40,0	40,0
2300654	I5191300-051050	2"	51,0	50,0
2302107	I5191300-065065	2 9/16"	65,0	65,0
2300657	I5191300-076080	3"	76,0	80,0
2302108	I5191300-081080	3 1/8"	80,0	80,0
2302109	I5191300-102100	4"	102,0	100,0
2300659	I5191300-105100	4 1/8"	105,0	100,0
2300661	I5191300-152150	6"	152,0	150,0

// SYMMETRIC GUILLEMIN NF E 29.572**Serrated hose shank with collar - with locking ring complete with seal - Stainless steel 316**

Item Code	Product Code	Hose ID	Hose ID	Head DN
		in	mm	mm
2302440	I3191300-040040	1 9/16"	40,0	40,0
2302102	I3191300-051050	2"	51,0	50,0
2302103	I3191300-065065	2 9/16"	65,0	65,0
2300626	I3191300-076080	3"	76,0	80,0
2302441	I3191300-080080	3 1/8"	80,0	80,0
2302104	I3191300-102100	4"	102,0	100,0

// SYMMETRIC GUILLEMIN NF E 29.572**Serrated hose shank with collar - with locking ring complete with seal - Bronze**

Item Code	Product Code	Hose ID	Hose ID	Head DN
		in	mm	mm
2300958	I7191300-040040	1 9/16"	40,0	40,0
2300683	I7191300-051050	2"	51,0	50,0
2300938	I7191300-065065	2 9/16"	65,0	65,0
2302066	I7191300-076080	3"	76,0	80,0
2300686	I7191300-080080	3 1/8"	80,0	80,0
2302068	I7191300-102100	4"	102,0	100,0

// SYMMETRIC GUILLEMIN NF E 29.572 - ADAPTER**// SYMMETRIC GUILLEMIN NF E 29.572****Symmetric with locking ring complete with seal - BSPP Male - Aluminium**

Item Code	Product Code	Thread type 1	Head DN side 1	Head DN side 1	Thread 1	Thread type 2	Head DN side 2	Head DN side 2	Thread 2
			in	mm			in	mm	
2300221	I5A91206-020027	SYM	13/16"	20,0	-	BSPP	3/4"	19,0	3/4"
2300222	I5A91206-025034	SYM	1"	25,0	-	BSPP	1"	25,0	1"
2302077	I5A91206-032042	SYM	1 1/4"	32,0	-	BSPP	1 1/4"	32,0	1"1/4
2300224	I5A91206-040049	SYM	1 9/16"	40,0	-	BSPP	1 1/2"	38,0	1"1/2
2300225	I5A91206-050060	SYM	2"	50,0	-	BSPP	2"	51,0	2"
2300226	I5A91206-065076	SYM	2 9/16"	65,0	-	BSPP	2 1/2"	63,0	2"1/2
2300227	I5A91206-080090	SYM	3 1/8"	80,0	-	BSPP	3"	76,0	3"
2300228	I5A91206-100114	SYM	4"	100,0	-	BSPP	4"	102,0	4"
2302695	I5A91206-150165	SYM	6"	150,0	-	BSPP	6"	152,0	6"

// SYMMETRIC GUILLEMIN NF E 29.572**Symmetric with locking ring complete with seal - BSPP Male - Stainless steel 316**

Item Code	Product Code	Thread type 1	Head DN side 1	Head DN side 1	Thread 1	Thread type 2	Head DN side 2	Head DN side 2	Thread 2
			in	mm			in	mm	
2302569	I3A91206-020027	SYM	13/16"	20,0	-	BSPP	3/4"	19,0	3/4"
2302570	I3A91206-025034	SYM	1"	25,0	-	BSPP	1"	25,0	1"
2302571	I3A91206-032042	SYM	1 1/4"	32,0	-	BSPP	1 1/4"	32,0	1"1/4
2302064	I3A91206-040049	SYM	1 9/16"	40,0	-	BSPP	1 1/2"	38,0	1"1/2
2300982	I3A91206-050060	SYM	2"	50,0	-	BSPP	2"	51,0	2"
2302572	I3A91206-065076	SYM	2 9/16"	65,0	-	BSPP	2 1/2"	63,0	2"1/2
2301660	I3A91206-080090	SYM	3 1/8"	80,0	-	BSPP	3"	76,0	3"
2301251	I3A91206-100114	SYM	4"	100,0	-	BSPP	4"	102,0	4"

// SYMMETRIC GUILLEMIN NF E 29.572**Symmetric with locking ring complete with seal - BSPP Male - Bronze**

Item Code	Product Code	Thread type 1	Head DN side 1	Head DN side 1	Thread 1	Thread type 2	Head DN side 2	Head DN side 2	Thread 2
			in	mm			in	mm	
2300296	I7A91206-020027	SYM	13/16"	20,0	-	BSPP	3/4"	19,0	3/4"
2300297	I7A91206-025034	SYM	1"	25,0	-	BSPP	1"	25,0	1"
2302072	I7A91206-032042	SYM	1 1/4"	32,0	-	BSPP	1 1/4"	32,0	1"1/4
2300299	I7A91206-040049	SYM	1 9/16"	40,0	-	BSPP	1 1/2"	38,0	1"1/2
2300300	I7A91206-050060	SYM	2"	50,0	-	BSPP	2"	51,0	2"
2300301	I7A91206-065076	SYM	2 9/16"	65,0	-	BSPP	2 1/2"	63,0	2"1/2
2300302	I7A91206-080090	SYM	3 1/8"	80,0	-	BSPP	3"	76,0	3"
2300303	I7A91206-100114	SYM	4"	100,0	-	BSPP	4"	102,0	4"

Dimensions shown may be changed without prior notice

// SYMMETRIC GUILLEMIN NF E 29.572

Symmetric without locking ring complete with seal - BSPP Male - Aluminium



Item Code	Product Code	Thread type 1	Head DN side 1	Head DN side 1	Thread 1	Thread type 2	Head DN side 2	Head DN side 2	Thread 2
			in	mm			in	mm	
2300247	I5A94206-020027	SYM.NL	13/16"	20,0	-	BSPP	3/4"	19,0	3/4"
2300248	I5A94206-025034	SYM.NL	1"	25,0	-	BSPP	1"	25,0	1"
2302153	I5A94206-032042	SYM.NL	1 1/4"	32,0	-	BSPP	1 1/4"	32,0	1"1/4
2300250	I5A94206-040049	SYM.NL	1 9/16"	40,0	-	BSPP	1 1/2"	38,0	1"1/2
2300251	I5A94206-050060	SYM.NL	2"	50,0	-	BSPP	2"	51,0	2"
2300252	I5A94206-065076	SYM.NL	2 9/16"	65,0	-	BSPP	2 1/2"	63,0	2"1/2
2300253	I5A94206-080090	SYM.NL	3 1/8"	80,0	-	BSPP	3"	76,0	3"
2300254	I5A94206-100114	SYM.NL	4"	100,0	-	BSPP	4"	102,0	4"

// SYMMETRIC GUILLEMIN NF E 29.572

Symmetric without locking ring complete with seal - BSPP Male - Stainless steel 316



Item Code	Product Code	Thread type 1	Head DN side 1	Head DN side 1	Thread 1	Thread type 2	Head DN side 2	Head DN side 2	Thread 2
			in	mm			in	mm	
2302579	I3A94206-020027	SYM.NL	13/16"	20,0	-	BSPP	3/4"	19,0	3/4"
2302580	I3A94206-025034	SYM.NL	1"	25,0	-	BSPP	1"	25,0	1"
2302581	I3A94206-032042	SYM.NL	1 1/4"	32,0	-	BSPP	1 1/4"	32,0	1"1/4
2302582	I3A94206-040049	SYM.NL	1 9/16"	40,0	-	BSPP	1 1/2"	38,0	1"1/2
2302583	I3A94206-050060	SYM.NL	2"	50,0	-	BSPP	2"	51,0	2"
2302584	I3A94206-065076	SYM.NL	2 9/16"	65,0	-	BSPP	2 1/2"	63,0	2"1/2
2302065	I3A94206-080090	SYM.NL	3 1/8"	80,0	-	BSPP	3"	76,0	3"
2302585	I3A94206-100114	SYM.NL	4"	100,0	-	BSPP	4"	102,0	4"

// SYMMETRIC GUILLEMIN NF E 29.572

Symmetric without locking ring complete with seal - BSPP Male - Bronze



Item Code	Product Code	Thread type 1	Head DN side 1	Head DN side 1	Thread 1	Thread type 2	Head DN side 2	Head DN side 2	Thread 2
			in	mm			in	mm	
2302750	I7A94206-020027	SYM.NL	13/16"	20,0	-	BSPP	3/4"	19,0	3/4"
2302751	I7A94206-025034	SYM.NL	1"	25,0	-	BSPP	1"	25,0	1"
2302752	I7A94206-032042	SYM.NL	1 1/4"	32,0	-	BSPP	1 1/4"	32,0	1"1/4
2300320	I7A94206-040049	SYM.NL	1 9/16"	40,0	-	BSPP	1 1/2"	38,0	1"1/2
2300321	I7A94206-050060	SYM.NL	2"	50,0	-	BSPP	2"	51,0	2"
2300322	I7A94206-065076	SYM.NL	2 9/16"	65,0	-	BSPP	2 1/2"	63,0	2"1/2
2300323	I7A94206-080090	SYM.NL	3 1/8"	80,0	-	BSPP	3"	76,0	3"
2300324	I7A94206-100114	SYM.NL	4"	100,0	-	BSPP	4"	102,0	4"

// SYMMETRIC GUILLEMIN NF E 29.572**Symmetric with locking ring complete with seal - BSPP Female - Aluminium**

Item Code	Product Code	Thread type 1	Head DN	Head DN	Thread 1	Thread type 2	Head DN	Head DN	Thread 2
			side 1	side 1			side 2	side 2	
			in	mm	in				in
2300229	I5A91306-020027	SYM	13/16"	20,0	-	BSPP	3/4"	19,0	3/4"
2300230	I5A91306-025034	SYM	1"	25,0	-	BSPP	1"	25,0	1"
2302078	I5A91306-032042	SYM	1 1/4"	32,0	-	BSPP	1 1/4"	32,0	1 1/4"
2300232	I5A91306-040049	SYM	1 9/16"	40,0	-	BSPP	1 1/2"	38,0	1 1/2"
2300233	I5A91306-050060	SYM	2"	50,0	-	BSPP	2"	51,0	2"
2300234	I5A91306-065076	SYM	2 9/16"	65,0	-	BSPP	2 1/2"	63,0	2 1/2"
2300235	I5A91306-080090	SYM	3 1/8"	80,0	-	BSPP	3"	76,0	3"
2300236	I5A91306-100114	SYM	4"	100,0	-	BSPP	4"	102,0	4"
2300237	I5A91306-150165	SYM	6"	150,0	-	BSPP	6"	152,0	6"

// SYMMETRIC GUILLEMIN NF E 29.572**Symmetric with locking ring complete with seal - BSPP Female - Stainless steel 316**

Item Code	Product Code	Thread type 1	Head DN	Head DN	Thread 1	Thread type 2	Head DN	Head DN	Thread 2
			side 1	side 1			side 2	side 2	
			in	mm	in				in
2302573	I3A91306-020027	SYM	13/16"	20,0	-	BSPP	3/4"	19,0	3/4"
2300161	I3A91306-025034	SYM	1"	25,0	-	BSPP	1"	25,0	1"
2302574	I3A91306-032042	SYM	1 1/4"	32,0	-	BSPP	1 1/4"	32,0	1 1/4"
2300163	I3A91306-040049	SYM	1 9/16"	40,0	-	BSPP	1 1/2"	38,0	1 1/2"
2300164	I3A91306-050060	SYM	2"	50,0	-	BSPP	2"	51,0	2"
2300165	I3A91306-065076	SYM	2 9/16"	65,0	-	BSPP	2 1/2"	63,0	2 1/2"
2300166	I3A91306-080090	SYM	3 1/8"	80,0	-	BSPP	3"	76,0	3"
2300167	I3A91306-100114	SYM	4"	100,0	-	BSPP	4"	102,0	4"

// SYMMETRIC GUILLEMIN NF E 29.572**Symmetric with locking ring complete with seal - BSPP Female - Bronze**

Item Code	Product Code	Thread type 1	Head DN	Head DN	Thread 1	Thread type 2	Head DN	Head DN	Thread 2
			side 1	side 1			side 2	side 2	
			in	mm	in				in
2300304	I7A91306-020027	SYM	13/16"	20,0	-	BSPP	3/4"	19,0	3/4"
2300305	I7A91306-025034	SYM	1"	25,0	-	BSPP	1"	25,0	1"
2302073	I7A91306-032042	SYM	1 1/4"	32,0	-	BSPP	1 1/4"	32,0	1 1/4"
2300307	I7A91306-040049	SYM	1 9/16"	40,0	-	BSPP	1 1/2"	38,0	1 1/2"
2300308	I7A91306-050060	SYM	2"	50,0	-	BSPP	2"	51,0	2"
2300309	I7A91306-065076	SYM	2 9/16"	65,0	-	BSPP	2 1/2"	63,0	2 1/2"
2300310	I7A91306-080090	SYM	3 1/8"	80,0	-	BSPP	3"	76,0	3"
2300311	I7A91306-100114	SYM	4"	100,0	-	BSPP	4"	102,0	4"

Dimensions shown may be changed without prior notice

// SYMMETRIC GUILLEMIN NF E 29.572

Symmetric without locking ring complete with seal - BSPP Female - Aluminium



Item Code	Product Code	Thread type 1	Head DN side 1	Head DN side 1	Thread 1	Thread type 2	Head DN side 2	Head DN side 2	Thread 2
			in	mm			in	mm	
2300255	I5A94306-020027	SYM.NL	13/16"	20,0	-	BSPP	3/4"	19,0	3/4"
2300256	I5A94306-025034	SYM.NL	1"	25,0	-	BSPP	1"	25,0	1"
2302697	I5A94306-032042	SYM.NL	1 1/4"	32,0	-	BSPP	1 1/4"	32,0	1"1/4
2300258	I5A94306-040049	SYM.NL	1 9/16"	40,0	-	BSPP	1 1/2"	38,0	1"1/2
2300259	I5A94306-050060	SYM.NL	2"	50,0	-	BSPP	2"	51,0	2"
2300260	I5A94306-065076	SYM.NL	2 9/16"	65,0	-	BSPP	2 1/2"	63,0	2"1/2
2300261	I5A94306-080090	SYM.NL	3 1/8"	80,0	-	BSPP	3"	76,0	3"
2300262	I5A94306-100114	SYM.NL	4"	100,0	-	BSPP	4"	102,0	4"

// SYMMETRIC GUILLEMIN NF E 29.572

Symmetric without locking ring complete with seal - BSPP Female - Stainless steel 316



Item Code	Product Code	Thread type 1	Head DN side 1	Head DN side 1	Thread 1	Thread type 2	Head DN side 2	Head DN side 2	Thread 2
			in	mm			in	mm	
2302586	I3A94306-020027	SYM.NL	13/16"	20,0	-	BSPP	3/4"	19,0	3/4"
2302587	I3A94306-025034	SYM.NL	1"	25,0	-	BSPP	1"	25,0	1"
2302588	I3A94306-032042	SYM.NL	1 1/4"	32,0	-	BSPP	1 1/4"	32,0	1"1/4
2302589	I3A94306-040049	SYM.NL	1 9/16"	40,0	-	BSPP	1 1/2"	38,0	1"1/2
2302067	I3A94306-050060	SYM.NL	2"	50,0	-	BSPP	2"	51,0	2"
2302590	I3A94306-065076	SYM.NL	2 9/16"	65,0	-	BSPP	2 1/2"	63,0	2"1/2
2302591	I3A94306-080090	SYM.NL	3 1/8"	80,0	-	BSPP	3"	76,0	3"
2302592	I3A94306-100114	SYM.NL	4"	100,0	-	BSPP	4"	102,0	4"

// SYMMETRIC GUILLEMIN NF E 29.572

Symmetric without locking ring complete with seal - BSPP Female - Bronze



Item Code	Product Code	Thread type 1	Head DN side 1	Head DN side 1	Thread 1	Thread type 2	Head DN side 2	Head DN side 2	Thread 2
			in	mm			in	mm	
2300325	I7A94306-020027	SYM.NL	13/16"	20,0	-	BSPP	3/4"	19,0	3/4"
2300326	I7A94306-025034	SYM.NL	1"	25,0	-	BSPP	1"	25,0	1"
2302753	I7A94306-032042	SYM.NL	1 1/4"	32,0	-	BSPP	1 1/4"	32,0	1"1/4
2300328	I7A94306-040049	SYM.NL	1 9/16"	40,0	-	BSPP	1 1/2"	38,0	1"1/2
2300329	I7A94306-050060	SYM.NL	2"	50,0	-	BSPP	2"	51,0	2"
2300330	I7A94306-065076	SYM.NL	2 9/16"	65,0	-	BSPP	2 1/2"	63,0	2"1/2
2300331	I7A94306-080090	SYM.NL	3 1/8"	80,0	-	BSPP	3"	76,0	3"
2300332	I7A94306-100114	SYM.NL	4"	100,0	-	BSPP	4"	102,0	4"

// SYMMETRIC GUILLEMIN NF E 29.572**Reducing adapter with locking rings complete with seal - Aluminium**

Item Code	Product Code	Thread type 1	Head DN side 1		Thread type 2	Head DN side 2	
			in	mm		in	mm
2300212	I5A91191-050040	SYM	2"	50,0	SYM	1 9/16"	40,0
2300214	I5A91191-065050	SYM	2 9/16"	65,0	SYM	2"	50,0
2300216	I5A91191-080050	SYM	3 1/8"	80,0	SYM	2"	50,0
2300217	I5A91191-080065	SYM	3 1/8"	80,0	SYM	2 9/16"	65,0
2300220	I5A91191-100080	SYM	4"	100,0	SYM	3 1/8"	80,0

Dimensions shown may be changed without prior notice

// SYMMETRIC GUILLEMIN NF E 29.572

Male plug with locking ring and chain - Aluminium



Item Code	Product Code	Thread type 1	Head DN side 1	Head DN side 1	Thread 1
			in	mm	
2300238	I5A91400-020	SYM	13/16"	20,0	-
2300239	I5A91400-025	SYM	1"	25,0	-
2302696	I5A91400-032	SYM	1 1/4"	32,0	-
2300241	I5A91400-040	SYM	1 9/16"	40,0	-
2300242	I5A91400-050	SYM	2"	50,0	-
2300243	I5A91400-065	SYM	2 9/16"	65,0	-
2300244	I5A91400-080	SYM	3 1/8"	80,0	-
2300245	I5A91400-100	SYM	4"	100,0	-
2300246	I5A91400-150	SYM	6"	150,0	-

// SYMMETRIC GUILLEMIN NF E 29.572

Male plug with locking ring and chain - Stainless steel 316



Item Code	Product Code	Thread type 1	Head DN side 1	Head DN side 1	Thread 1
			in	mm	
2302575	I3A91400-020	SYM	13/16"	20,0	-
2302576	I3A91400-025	SYM	1"	25,0	-
2302577	I3A91400-032	SYM	1 1/4"	32,0	-
2300168	I3A91400-040	SYM	1 9/16"	40,0	-
2301038	I3A91400-050	SYM	2"	50,0	-
2300169	I3A91400-065	SYM	2 9/16"	65,0	-
2300096	I3A91400-080	SYM	3 1/8"	80,0	-
2302578	I3A91400-100	SYM	4"	100,0	-

// SYMMETRIC GUILLEMIN NF E 29.572

Male plug with locking ring and chain - Bronze



Item Code	Product Code	Thread type 1	Head DN side 1	Head DN side 1	Thread 1
			in	mm	
2300312	I7A91400-020	SYM	13/16"	20,0	-
2300313	I7A91400-025	SYM	1"	25,0	-
2302149	I7A91400-032	SYM	1 1/4"	32,0	-
2300315	I7A91400-040	SYM	1 9/16"	40,0	-
2300316	I7A91400-050	SYM	2"	50,0	-
2300317	I7A91400-065	SYM	2 9/16"	65,0	-
2300318	I7A91400-080	SYM	3 1/8"	80,0	-
2300319	I7A91400-100	SYM	4"	100,0	-

// SYMMETRIC GUILLEMIN NF E 29.572**Handled male plug without locking ring - with chain - Aluminium**

Item Code	Product Code	Thread type 1	Head DN side 1	Head DN side 1	Thread 1
			in	mm	in
2300263	I5A94400-040	SYM.NL	1 9/16"	40,0	-
2300264	I5A94400-050	SYM.NL	2"	50,0	-
2300265	I5A94400-065	SYM.NL	2 9/16"	65,0	-
2300266	I5A94400-080	SYM.NL	3 1/8"	80,0	-
2300267	I5A94400-100	SYM.NL	4"	100,0	-

Dimensions shown may be changed without prior notice

// SYMMETRIC GUILLEMIN NF E 29.572 - SEAL & ACCESSORY**// SYMMETRIC GUILLEMIN NF E 29.572****Seal - NBR**

Item Code	Product Code	DN	DN
		mm	in
2300497	INJ091-020	20	13/16"
2300498	INJ091-025	25	1"
2301659	INJ091-032	32	1 1/4"
2300500	INJ091-040	40	1 9/16"
2300501	INJ091-050	50	2"
2300502	INJ091-065	65	2 9/16"
2300503	INJ091-080	80	3 1/8"
2300504	INJ091-100	100	4"
2302862	INJ091-150	150	6"

// SYMMETRIC GUILLEMIN NF E 29.572**Seal - white NBR - food grade**

Item Code	Product Code	DN	DN
		mm	in
2300988	IBJ091-050	50	2"
2300456	IBJ091-080	80	3 1/8"
2300457	IBJ091-100	100	4"

// SYMMETRIC GUILLEMIN NF E 29.572**Seal - PTFE**

Item Code	Product Code	DN	DN
		mm	in
2302884	ITJ091-020	20	13/16"
2302885	ITJ091-025	25	1"
2300514	ITJ091-032	32	1 1/4"
2300515	ITJ091-040	40	1 9/16"
2300516	ITJ091-050	50	2"
2300517	ITJ091-065	65	2 9/16"
2300518	ITJ091-080	80	3 1/8"
2300987	ITJ091-100	100	4"

// SYMMETRIC GUILLEMIN NF E 29.572**Wrenches - Universal - Plated steel**

Item Code	Product Code	DN	DN (min)	DN (max)	Technical Note
		in	mm	mm	
2301057	I0YT000-020120	13/16" - 4 1/2"	20	115	WRENCH UNIVERSAL

// SYMMETRIC GUILLEMIN NF E 29.572**Wrenches - Universal - Bronze**

Item Code	Product Code	DN	DN (min)	DN (max)	Technical Note
		in	mm	mm	
2300588	I7YT030-020115	13/16" - 4 1/2"	20	115	WRENCH UNIVERSAL

// SYMMETRIC GUILLEMIN NF E 29.572**Wrenches - Simple - Plated steel**

Item Code	Product Code	DN	DN (min)	DN (max)	Technical Note
		in	mm	mm	
2300572	I0YT000-020065	13/16" - 2 9/16"	20	65	WRENCH SIMPLE

// SYMMETRIC GUILLEMIN NF E 29.572**Wrenches - Simple - Copper Alloy**

Item Code	Product Code	DN	DN (min)	DN (max)	Technical Note
		in	mm	mm	
2300586	I6YT000-020065	13/16" - 2 9/16"	20	65	WRENCH SIMPLE

// SYMMETRIC GUILLEMIN NF E 29.572**Wrenches - Oil tanker - Copper Alloy**

Item Code	Product Code	DN	DN (min)	DN (max)	Technical Note
		in	mm	mm	
2300587	I6YT000-050100	2" - 4"	50	100	WRENCH "PETROLIER"



// SYMMETRIC DSP & AR (NF S 61.704 - NF S 61.705)

// SYMMETRIC DSP NF S 61.704	204
// SYMMETRIC AR NF S 61.705	204

// SYMMETRIC DSP NF S 61.704

// SYMMETRIC DSP NF S 61.704

Serrated hose shank with locking ring complete with seal - Aluminium



Item Code	Product Code	Hose ID	Hose ID	Head DN
		in	mm	mm
2300663	I5193300-045040	1 3/4"	45,0	40,0
2300664	I5193300-070065	2 3/4"	70,0	65,0

// SYMMETRIC AR NF S 61.705

// SYMMETRIC AR NF S 61.705

Serrated hose shank with locking ring complete with seal - Aluminium



Item Code	Product Code	Hose ID	Hose ID	Head DN
		in	mm	mm
2300662	I5192300-110100	4 5/16"	110,0	100,0



// GFR - ROUND THREAD COUPLING NF E 29.579

// GFR - ROUND THREAD COUPLING NF E 29.579 - HOSE SHANK206

// GFR - ROUND THREAD COUPLING NF E 29.579 - HOSE SHANK**// GFR - ROUND THREAD COUPLING NF E 29.579****GFR Male - Hose shank - Bronze**

Item Code	Product Code	Hose ID	Hose ID	Head DN	Head DN
		in	mm	in	mm
2300674	I7190100-025020	1"	25,0	3/4"	20,0

For hose 251AA

// GFR - ROUND THREAD COUPLING NF E 29.579**GFR swivel Female - Hose shank complete with seal - Bronze**

Item Code	Product Code	Hose ID	Hose ID	Head DN	Head DN
		in	mm	in	mm
2300675	I7190200-025020	1"	25,0	3/4"	20,0

For hose 251AA



// STORZ

// STORZ - HOSE SHANK.....	208
// STORZ - ADAPTER.....	209

// STORZ - HOSE SHANK

// STORZ

Suction & delivery hose shank complete with seal - Aluminium

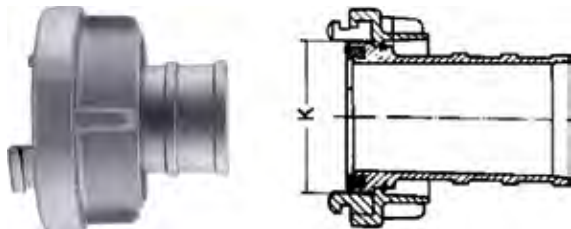

Item Code	Product Code	Hose ID	Hose ID	Head DN	Claw Distance Internal	Technical Note
		in	mm		mm	
2306056	I519Z300-019025	3/4"	19,0	25,0	31	TYPE D-DS
2305397	I519Z300-025025	1"	25,0	25,0	31	TYPE D-DS
2306058	I519Z300-025052	1"	25,0	52,0	66	TYPE C-DS
2302681	I519Z300-032032	1 1/4"	32,0	32,0	44	TYPE DS
2306057	I519Z300-032052	1 1/4"	32,0	52,0	66	TYPE C-DS
2302682	I519Z300-038038	1 1/2"	38,0	38,0	51	TYPE DS
2305089	I519Z300-038052	1 1/2"	38,0	52,0	66	TYPE C-DS
2303000	I519Z300-045052	1 3/4"	45,0	52,0	66	TYPE C-DS
2301825	I519Z300-051052	2"	51,0	52,0	66	TYPE C-DS
2306193	I519Z300-063075	2 1/2"	63,0	75,0	89	TYPE B-DS
2301764	I519Z300-076075	3"	76,0	75,0	89	TYPE B-DS
2302684	I519Z300-102100	4"	102,0	100,0	115	TYPE DS
2305301	I519Z300-102110	4"	102,0	110,0	133	TYPE A-DS
2300647	I519Z300-110110	4 5/16"	110,0	110,0	133	TYPE A-DS
2306192	I519Z300-125125	5"	127,0	125,0	148	TYPE DS
2306059	I519Z300-152150	6"	152,0	150,0	160	TYPE DS

Dimensions shown may be changed without prior notice

// STORZ - ADAPTER

// STORZ

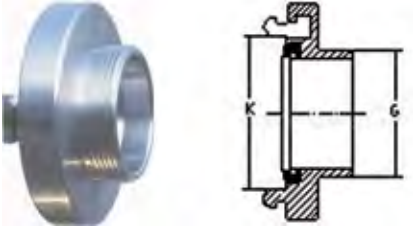
BSPP Male complete with seal - Aluminium

Item Code	Product Code	Head DN side 1	Head DN side 1	Claw Distance Internal side 1	Claw Distance External side 1	Technical Note side 1	Thread type 2	Thread 2
		in	mm	mm	mm			in
2306195	I5A9Z206-025027	1"	25,0	31	-	TYPE D-DS	BSPP	3/4"
2302714	I5A9Z206-025034	1"	25,0	31	-	TYPE D-DS	BSPP	1"
2302715	I5A9Z206-032042	1 1/4"	32,0	44	-	TYPE DS	BSPP	1"1/4
2302716	I5A9Z206-038049	1 1/2"	38,0	51	-	TYPE DS	BSPP	1"1/2
2305920	I5A9Z206-052034	2"	52,0	66	-	TYPE C-DS	BSPP	1"
2305922	I5A9Z206-052042	2"	52,0	66	-	TYPE C-DS	BSPP	1"1/4
2305090	I5A9Z206-052049	2"	52,0	66	-	TYPE C	BSPP	1"1/2
2300208	I5A9Z206-052060	2"	52,0	66	-	TYPE C-DS	BSPP	2"
2305925	I5A9Z206-075076	3"	75,0	89	-	TYPE B-DS	BSPP	2"1/2
2301743	I5A9Z206-075090	3"	75,0	89	-	TYPE B-DS	BSPP	3"
2302717	I5A9Z206-100114	4"	100,0	115	-	TYPE DS	BSPP	4"
2302718	I5A9Z206-110114	4 5/16"	110,0	133	-	TYPE A-DS	BSPP	4"

// STORZ

BSPP Female complete with seal - Aluminium

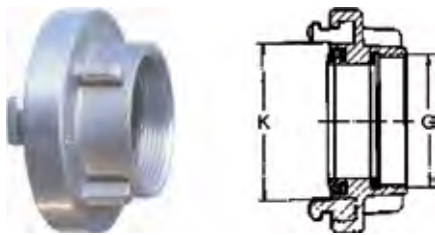

Item Code	Product Code	Head DN side 1	Head DN side 1	Claw Distance Internal side 1	Claw Distance External side 1	Technical Note side 1	Thread type 2	Thread 2
		in	mm	mm	mm			in
2306194	I5A9Z306-025021	1"	25,0	31	-	TYPE D-DS	BSPP	1/2"
2305918	I5A9Z306-025027	1"	25,0	31	-	TYPE D-DS	BSPP	3/4"
2305400	I5A9Z306-025034	1"	25,0	31	-	TYPE D-DS	BSPP	1"
2302719	I5A9Z306-032042	1 1/4"	32,0	44	-	TYPE DS	BSPP	1"1/4
2301717	I5A9Z306-038060	1 1/2"	38,0	51	-	TYPE DS	BSPP	2"
2305919	I5A9Z306-052034	2"	52,0	66	-	TYPE C-DS	BSPP	1"
2305921	I5A9Z306-052042	2"	52,0	66	-	TYPE C-DS	BSPP	1"1/4
2305086	I5A9Z306-052049	2"	52,0	66	-	TYPE C-DS	BSPP	1"1/2
2302720	I5A9Z306-052060	2"	52,0	66	-	TYPE C-DS	BSPP	2"
2305923	I5A9Z306-052076	2"	52,0	66	-	TYPE C-DS	BSPP	2"1/2
2305087	I5A9Z306-065076	2 1/2"	65,0	81	-	TYPE DS	BSPP	2"1/2
2305403	I5A9Z306-075060	3"	75,0	89	-	TYPE B-DS	BSPP	2"
2305924	I5A9Z306-075076	3"	75,0	89	-	TYPE B-DS	BSPP	2"1/2
2301688	I5A9Z306-075090	3"	75,0	89	-	TYPE B-DS	BSPP	3"
2302721	I5A9Z306-100114	4"	100,0	115	-	TYPE DS	BSPP	4"
2302722	I5A9Z306-110114	4 5/16"	110,0	133	-	TYPE A-DS	BSPP	4"
2306196	I5A9Z306-125140	5"	125,0	148	-	TYPE DS	BSPP	5"
2305404	I5A9Z306-150165	6"	150,0	160	-	TYPE DS	BSPP	6"

// STORZ

Reducer adapter complete with seal - Aluminium

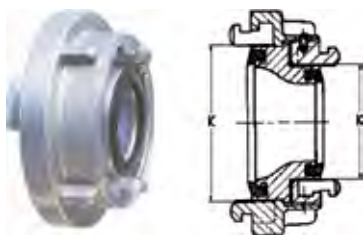

Item Code	Product Code	Head DN side 1	Head DN side 1	Claw Distance Internal side 1	Claw Distance External side 1	Technical Note side 1	Thread type 2	Head DN side 2	Head DN side 2	Claw Distance Internal side 2	Claw Distance External side 2	Technical Note side 2
		in	mm	mm	mm			in	mm	mm	mm	
2305927	I5A9Z19Z-052025	2"	52,0	66	-	TYPE C-DS	STORZ	1"	25,0	31	-	TYPE D-DS
2305091	I5A9Z19Z-075052	3"	75,0	89	-	TYPE B-DS	STORZ	2"	52,0	66	-	TYPE C-DS
2305928	I5A9Z19Z-100075	4"	100,0	115	-	TYPE DS	STORZ	3"	75,0	89	-	TYPE B-DS
2305092	I5A9Z19Z-110075	4 5/16"	110,0	133	-	TYPE A-DS	STORZ	3"	75,0	89	-	TYPE B-DS
2305929	I5A9Z19Z-110100	4 5/16"	110,0	133	-	TYPE A-DS	STORZ	4"	100,0	115	-	TYPE DS

Dimensions shown may be changed without prior notice

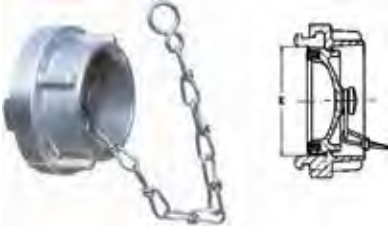
// STORZ**Blank cap with chain complete with seal - Aluminium**

Item Code	Product Code	Head DN side 1	Head DN side 1	Claw Distance Internal side 1	Claw Distance External side 1	Technical Note side 1
		in	mm	mm	mm	
2302723	I5A9Z400-025	1"	25,0	31	-	TYPE D-DS
2302724	I5A9Z400-032	1 1/4"	32,0	44	-	TYPE DS
2302725	I5A9Z400-038	1 1/2"	38,0	51	-	TYPE DS
2302726	I5A9Z400-052	2"	52,0	66	-	TYPE C-DS
2305088	I5A9Z400-065	2 1/2"	65,0	81	-	TYPE DS
2301742	I5A9Z400-075	3"	75,0	89	-	TYPE B-DS
2302727	I5A9Z400-100	4"	100,0	115	-	TYPE DS
2302728	I5A9Z400-110	4 5/16"	110,0	133	-	TYPE A-DS
2305399	I5A9Z400-150	-	150,0	160	-	TYPE DS



// TANKWAGEN

// TANKWAGEN EN 14 420-6 / DIN 28 450 213

Dimensions shown may be changed without prior notice

// TANKWAGEN EN 14 420-6 / DIN 28 450

// TANKWAGEN EN 14 420-6 / DIN 28 450

Type VK - Male part - BSPP Female - Stainless steel 316



Item Code	Product Code	Thread type 1	Head DN side 1	Head DN side 1	Thread 1	Thread type 2	Head DN side 2	Head DN side 2	Thread 2
			in	mm			in	mm	
2302636	I3A9T606-050060	TW	2"	50,0	-	BSPP	2"	51,0	2"
2301815	I3A9T606-080090	TW	3 1/8"	80,0	-	BSPP	3"	76,0	3"
2305915	I3A9T606-100114	TW	4"	100,0	-	BSPP	4"	102,0	4"

// TANKWAGEN EN 14 420-6 / DIN 28 450

Type VK - Male part - BSPP Female - Brass



Item Code	Product Code	Thread type 1	Head DN side 1	Head DN side 1	Thread 1	Thread type 2	Head DN side 2	Head DN side 2	Thread 2
			in	mm			in	mm	
2302803	I8A9T606-050060	TW	2"	50,0	-	BSPP	2"	51,0	2"
2302804	I8A9T606-080090	TW	3 1/8"	80,0	-	BSPP	3"	76,0	3"
2301395	I8A9T606-100114	TW	4"	100,0	-	BSPP	4"	102,0	4"

// TANKWAGEN EN 14 420-6 / DIN 28 450

Type MK - Female part complete with locking handle and seal - BSPP Female - Stainless steel 316



Item Code	Product Code	Thread type 1	Head DN side 1	Head DN side 1	Thread 1	Thread type 2	Head DN side 2	Head DN side 2	Thread 2
			in	mm			in	mm	
2302638	I3A9T806-050060	TW	2"	50,0	-	BSPP	2"	51,0	2"
2302639	I3A9T806-080090	TW	3 1/8"	80,0	-	BSPP	3"	76,0	3"
2305914	I3A9T806-100114	TW	4"	100,0	-	BSPP	4"	102,0	4"

// TANKWAGEN EN 14 420-6 / DIN 28 450

Type MK - Female part complete with locking handle and seal - BSPP Female - Brass



Item Code	Product Code	Thread type 1	Head DN side 1	Head DN side 1	Thread 1	Thread type 2	Head DN side 2	Head DN side 2	Thread 2
			in	mm			in	mm	
2302807	I8A9T806-050060	TW	2"	50,0	-	BSPP	2"	51,0	2"
2301827	I8A9T806-080090	TW	3 1/8"	80,0	-	BSPP	3"	76,0	3"
2301394	I8A9T806-100114	TW	4"	100,0	-	BSPP	4"	102,0	4"

// TANKWAGEN EN 14 420-6 / DIN 28 450**Type VB - Male plug - Aluminium**

Item Code	Product Code	Thread type 1	Head DN side 1	Head DN side 1	Thread 1
			in	mm	in
2306088	I5A9T700-050	TW	2"	50,0	-
2305916	I5A9T700-080	TW	3 1/8"	80,0	-
2306090	I5A9T700-100	TW	4"	100,0	-

// TANKWAGEN EN 14 420-6 / DIN 28 450**Type VB - Male plug - Stainless steel 316**

Item Code	Product Code	Thread type 1	Head DN side 1	Head DN side 1	Thread 1
			in	mm	in
2302637	I3A9T700-050	TW	2"	50,0	-
2301537	I3A9T700-080	TW	3 1/8"	80,0	-
2306089	I3A9T700-100	TW	4"	100,0	-

// TANKWAGEN EN 14 420-6 / DIN 28 450**Type VB - Male plug - Brass**

Item Code	Product Code	Thread type 1	Head DN side 1	Head DN side 1	Thread 1
			in	mm	in
2302805	I8A9T700-050	TW	2"	50,0	-
2301828	I8A9T700-080	TW	3 1/8"	80,0	-

// TANKWAGEN EN 14 420-6 / DIN 28 450**Type VB - Male plug - PP**

Item Code	Product Code	Thread type 1	Head DN side 1	Head DN side 1	Thread 1
			in	mm	in
2305368	IPA9T700-050	TW	2"	50,0	-
2305369	IPA9T700-080	TW	3 1/8"	80,0	-
2305370	IPA9T700-100	TW	4"	100,0	-

Dimensions shown may be changed without prior notice

// TANKWAGEN EN 14 420-6 / DIN 28 450**Type MB - Female Cup - Aluminium**

Item Code	Product Code	Thread type 1	Head DN side 1	Head DN side 1	Thread 1
			in	mm	in
2305364	I5A9T900-050	TW	2"	50,0	-
2305365	I5A9T900-080	TW	3 1/8"	80,0	-
2305366	I5A9T900-100	TW	4"	100,0	-

// TANKWAGEN EN 14 420-6 / DIN 28 450**Type MB - Female Cup - Stainless steel 316**

Item Code	Product Code	Thread type 1	Head DN side 1	Head DN side 1	Thread 1
			in	mm	in
2302640	I3A9T900-050	TW	2"	50,0	-
2301538	I3A9T900-080	TW	3 1/8"	80,0	-
2302809	I3A9T900-100	TW	4"	100,0	-

// TANKWAGEN EN 14 420-6 / DIN 28 450**Type MB - Female Cup - Brass**

Item Code	Product Code	Thread type 1	Head DN side 1	Head DN side 1	Thread 1
			in	mm	in
2302808	I8A9T900-050	TW	2"	50,0	-
2301829	I8A9T900-080	TW	3 1/8"	80,0	-

// TANKWAGEN EN 14 420-6 / DIN 28 450**Profiled Seal for type MK - NBR**

Item Code	Product Code	DN	DN
		mm	in
2302876	INJM9T-050	50	2"
2302877	INJM9T-080	80	3 1/8"
2302878	INJM9T-100	100	4"

// TANKWAGEN EN 14 420-6 / DIN 28 450**Profiled Seal for type MK - CSM**

Item Code	Product Code	DN	DN
		mm	in
2302860	IHJM9T-050	50	2"
2302861	IHJM9T-080	80	3 1/8"

// TANKWAGEN EN 14 420-6 / DIN 28 450**Profiled Seal for type MK - FKM/FPM**

Item Code	Product Code	DN	DN
		mm	in
2306843	-	50	2"
2304385	-	80	3 1/8"

// TANKWAGEN EN 14 420-6 / DIN 28 450**Square Seal for type MK and VK thread end - PTFE**

Item Code	Product Code	DN	DN
		mm	in
2302886	ITJ09T-050	50	2"
2302887	ITJ09T-080	80	3 1/8"

Dimensions shown may be changed without prior notice

// TANKWAGEN EN 14 420-6 / DIN 28 450**Square Seal for type MK and VK thread end - Polyurethane**

Item Code	Product Code	DN	DN
		mm	in
2304383	-	50	2"
2304386	-	80	3 1/8"
2304387	-	100	4"

// TANKWAGEN EN 14 420-6 / DIN 28 450**Square Seal for type MB - NBR**

Item Code	Product Code	DN	DN
		mm	in
2302866	INJ09T-050	50	2"
2302867	INJ09T-080	80	3 1/8"
2302868	INJ09T-100	100	4"

// TANKWAGEN EN 14 420-6 / DIN 28 450**Square Seal for type MB - CSM**

Item Code	Product Code	DN	DN
		mm	in
2302858	IHJ09T-050	50	2"
2302859	IHJ09T-080	80	3 1/8"



// CAM & GROOVE

// CAM & GROOVE MIL A-A-59326A / MIL C-27487 - TYPE A	219
// CAM & GROOVE MIL A-A-59326A / MIL C-27487 - TYPE B	223
// CAM & GROOVE MIL A-A-59326A / MIL C-27487 - TYPE C	227
// CAM & GROOVE MIL A-A-59326A / MIL C-27487 - TYPE D	229
// CAM & GROOVE MIL A-A-59326A / MIL C-27487 - TYPE E.....	233
// CAM & GROOVE MIL A-A-59326A / MIL C-27487 - TYPE F.....	235
// CAM & GROOVE MIL A-A-59326A / MIL C-27487 - TYPE DC.....	239
// CAM & GROOVE MIL A-A-59326A / MIL C-27487 - TYPE DP	241
// CAM & GROOVE EN 14 420-7 / DIN 2828 - TYPE A	243
// CAM & GROOVE EN 14 420-7 / DIN 2828 - TYPE C	243
// CAM & GROOVE EN 14 420-7 / DIN 2828 - TYPE D	244
// CAM & GROOVE EN 14 420-7 / DIN 2828 - TYPE E.....	244
// CAM & GROOVE - SEAL	245
// CAM & GROOVE - ACCESSORY	246

Dimensions shown may be changed without prior notice

// CAM & GROOVE MIL A-A-59326A / MIL C-27487 - TYPE A**// CAM & GROOVE MIL A-A-59326A / MIL C-27487****Type A - Adapter, BSPP Female - Aluminium**

Item Code	Product Code	Thread type 1	Head DN side 1	Head DN side 1	Thread 1	Thread type 2	Head DN side 2	Head DN side 2	Thread 2
			in	mm			in	mm	
2303234	I5A9C606-013021	C&G	1/2"	13,0	-	BSPP	1/2"	13,0	1/2"
2301830	I5A9C606-019027	C&G	3/4"	19,0	-	BSPP	3/4"	19,0	3/4"
2300182	I5A9C606-025034	C&G	1"	25,0	-	BSPP	1"	25,0	1"
2300183	I5A9C606-032042	C&G	1 1/4"	32,0	-	BSPP	1 1/4"	32,0	1"1/4
2301831	I5A9C606-038049	C&G	1 1/2"	38,0	-	BSPP	1 1/2"	38,0	1"1/2
2301832	I5A9C606-051060	C&G	2"	51,0	-	BSPP	2"	51,0	2"
2301833	I5A9C606-063076	C&G	2 1/2"	63,0	-	BSPP	2 1/2"	63,0	2"1/2
2301834	I5A9C606-076090	C&G	3"	76,0	-	BSPP	3"	76,0	3"
2301835	I5A9C606-102114	C&G	4"	102,0	-	BSPP	4"	102,0	4"
2302706	I5A9C606-127140	C&G	5"	127,0	-	BSPP	5"	127,0	5"
2301836	I5A9C606-152165	C&G	6"	152,0	-	BSPP	6"	152,0	6"

// CAM & GROOVE MIL A-A-59326A / MIL C-27487**Type A - Adapter, BSPP Female - Stainless steel 316**

Item Code	Product Code	Thread type 1	Head DN side 1	Head DN side 1	Thread 1	Thread type 2	Head DN side 2	Head DN side 2	Thread 2
			in	mm			in	mm	
2303236	I3A9C606-013021	C&G	1/2"	13,0	-	BSPP	1/2"	13,0	1/2"
2301837	I3A9C606-019027	C&G	3/4"	19,0	-	BSPP	3/4"	19,0	3/4"
2300148	I3A9C606-025034	C&G	1"	25,0	-	BSPP	1"	25,0	1"
2300149	I3A9C606-032042	C&G	1 1/4"	32,0	-	BSPP	1 1/4"	32,0	1"1/4
2301838	I3A9C606-038049	C&G	1 1/2"	38,0	-	BSPP	1 1/2"	38,0	1"1/2
2301839	I3A9C606-051060	C&G	2"	51,0	-	BSPP	2"	51,0	2"
2301840	I3A9C606-063076	C&G	2 1/2"	63,0	-	BSPP	2 1/2"	63,0	2"1/2
2302602	I3A9C606-076090	C&G	3"	76,0	-	BSPP	3"	76,0	3"
2302603	I3A9C606-102114	C&G	4"	102,0	-	BSPP	4"	102,0	4"
2302604	I3A9C606-152165	C&G	6"	152,0	-	BSPP	6"	152,0	6"

// CAM & GROOVE MIL A-A-59326A / MIL C-27487

Type A - Adapter, BSPP Female - Brass



Item Code	Product Code	Thread type 1	Head DN side 1	Head DN side 1	Thread 1	Thread type 2	Head DN side 2	Head DN side 2	Thread 2
			in	mm			in	mm	
2303235	I8A9C606-013021	C&G	1/2"	13,0	-	BSPP	1/2"	13,0	1/2"
2301841	I8A9C606-019027	C&G	3/4"	19,0	-	BSPP	3/4"	19,0	3/4"
2301842	I8A9C606-025034	C&G	1"	25,0	-	BSPP	1"	25,0	1"
2302789	I8A9C606-032042	C&G	1 1/4"	32,0	-	BSPP	1 1/4"	32,0	1"1/4
2302790	I8A9C606-038049	C&G	1 1/2"	38,0	-	BSPP	1 1/2"	38,0	1"1/2
2301843	I8A9C606-051060	C&G	2"	51,0	-	BSPP	2"	51,0	2"
2301844	I8A9C606-063076	C&G	2 1/2"	63,0	-	BSPP	2 1/2"	63,0	2"1/2
2301845	I8A9C606-076090	C&G	3"	76,0	-	BSPP	3"	76,0	3"
2301846	I8A9C606-102114	C&G	4"	102,0	-	BSPP	4"	102,0	4"

// CAM & GROOVE MIL A-A-59326A / MIL C-27487

Type A - Adapter, BSPP Female - PP



Item Code	Product Code	Thread type 1	Head DN side 1	Head DN side 1	Thread 1	Thread type 2	Head DN side 2	Head DN side 2	Thread 2
			in	mm			in	mm	
2303259	IPA9C606-013021	C&G	1/2"	13,0	-	BSPP	1/2"	13,0	1/2"
2303260	IPA9C606-019027	C&G	3/4"	19,0	-	BSPP	3/4"	19,0	3/4"
2303261	IPA9C606-025034	C&G	1"	25,0	-	BSPP	1"	25,0	1"
2303262	IPA9C606-032042	C&G	1 1/4"	32,0	-	BSPP	1 1/4"	32,0	1"1/4
2303263	IPA9C606-038049	C&G	1 1/2"	38,0	-	BSPP	1 1/2"	38,0	1"1/2
2303264	IPA9C606-051060	C&G	2"	51,0	-	BSPP	2"	51,0	2"
2303266	IPA9C606-076090	C&G	3"	76,0	-	BSPP	3"	76,0	3"
2303267	IPA9C606-102114	C&G	4"	102,0	-	BSPP	4"	102,0	4"

Dimensions shown may be changed without prior notice

// CAM & GROOVE MIL A-A-59326A / MIL C-27487

Type A - Adapter, NPT Female - Aluminium



Item Code	Product Code	Thread type 1	Head DN side 1		Thread 1	Thread type 2	Head DN side 2		Thread 2
			in	mm			in	mm	
2303469	I5A9C628-013021	C&G	1/2"	13,0	-	NPT	1/2"	13,0	1/2"
2303470	I5A9C628-019027	C&G	3/4"	19,0	-	NPT	3/4"	19,0	3/4"
2303471	I5A9C628-025034	C&G	1"	25,0	-	NPT	1"	25,0	1"
2303472	I5A9C628-032042	C&G	1 1/4"	32,0	-	NPT	1 1/4"	32,0	1"1/4
2303473	I5A9C628-038049	C&G	1 1/2"	38,0	-	NPT	1 1/2"	38,0	1"1/2
2303474	I5A9C628-051060	C&G	2"	51,0	-	NPT	2"	51,0	2"
2303475	I5A9C628-063076	C&G	2 1/2"	63,0	-	NPT	2 1/2"	63,0	2"1/2
2303476	I5A9C628-076090	C&G	3"	76,0	-	NPT	3"	76,0	3"
2303477	I5A9C628-102114	C&G	4"	102,0	-	NPT	4"	102,0	4"
2303478	I5A9C628-127140	C&G	5"	127,0	-	NPT	5"	127,0	5"
2303479	I5A9C628-152165	C&G	6"	152,0	-	NPT	6"	152,0	6"
2303480	I5A9C628-203219	C&G	8"	203,0	-	NPT	8"	203,0	8"

// CAM & GROOVE MIL A-A-59326A / MIL C-27487

Type A - Adapter, NPT Female - Stainless steel 316



Item Code	Product Code	Thread type 1	Head DN side 1		Thread 1	Thread type 2	Head DN side 2		Thread 2
			in	mm			in	mm	
2303492	I3A9C628-013021	C&G	1/2"	13,0	-	NPT	1/2"	13,0	1/2"
2303493	I3A9C628-019027	C&G	3/4"	19,0	-	NPT	3/4"	19,0	3/4"
2303494	I3A9C628-025034	C&G	1"	25,0	-	NPT	1"	25,0	1"
2303495	I3A9C628-032042	C&G	1 1/4"	32,0	-	NPT	1 1/4"	32,0	1"1/4
2303496	I3A9C628-038049	C&G	1 1/2"	38,0	-	NPT	1 1/2"	38,0	1"1/2
2303497	I3A9C628-051060	C&G	2"	51,0	-	NPT	2"	51,0	2"
2303498	I3A9C628-063076	C&G	2 1/2"	63,0	-	NPT	2 1/2"	63,0	2"1/2
2303499	I3A9C628-076090	C&G	3"	76,0	-	NPT	3"	76,0	3"
2303500	I3A9C628-102114	C&G	4"	102,0	-	NPT	4"	102,0	4"
2303501	I3A9C628-127140	C&G	5"	127,0	-	NPT	5"	127,0	5"
2303502	I3A9C628-152165	C&G	6"	152,0	-	NPT	6"	152,0	6"
2303503	I3A9C628-203219	C&G	8"	203,0	-	NPT	8"	203,0	8"

// CAM & GROOVE MIL A-A-59326A / MIL C-27487

Type A - Adapter, NPT Female - Brass



Item Code	Product Code	Thread type 1	Head DN side 1	Head DN side 1	Thread 1	Thread type 2	Head DN side 2	Head DN side 2	Thread 2
			in	mm			in	mm	
2303481	I8A9C628-013021	C&G	1/2"	13,0	-	NPT	1/2"	13,0	1/2"
2303482	I8A9C628-019027	C&G	3/4"	19,0	-	NPT	3/4"	19,0	3/4"
2303483	I8A9C628-025034	C&G	1"	25,0	-	NPT	1"	25,0	1"
2303484	I8A9C628-032042	C&G	1 1/4"	32,0	-	NPT	1 1/4"	32,0	1"1/4
2303485	I8A9C628-038049	C&G	1 1/2"	38,0	-	NPT	1 1/2"	38,0	1"1/2
2303486	I8A9C628-051060	C&G	2"	51,0	-	NPT	2"	51,0	2"
2303487	I8A9C628-063076	C&G	2 1/2"	63,0	-	NPT	2 1/2"	63,0	2"1/2
2303488	I8A9C628-076090	C&G	3"	76,0	-	NPT	3"	76,0	3"
2303489	I8A9C628-102114	C&G	4"	102,0	-	NPT	4"	102,0	4"
2303490	I8A9C628-127140	C&G	5"	127,0	-	NPT	5"	127,0	5"
2303491	I8A9C628-152165	C&G	6"	152,0	-	NPT	6"	152,0	6"

// CAM & GROOVE MIL A-A-59326A / MIL C-27487

Type A - Adapter, NPT Female - PP



Item Code	Product Code	Thread type 1	Head DN side 1	Head DN side 1	Thread 1	Thread type 2	Head DN side 2	Head DN side 2	Thread 2
			in	mm			in	mm	
2303504	IPA9C628-013021	C&G	1/2"	13,0	-	NPT	1/2"	13,0	1/2"
2303505	IPA9C628-019027	C&G	3/4"	19,0	-	NPT	3/4"	19,0	3/4"
2303506	IPA9C628-025034	C&G	1"	25,0	-	NPT	1"	25,0	1"
2303507	IPA9C628-032042	C&G	1 1/4"	32,0	-	NPT	1 1/4"	32,0	1"1/4
2303508	IPA9C628-038049	C&G	1 1/2"	38,0	-	NPT	1 1/2"	38,0	1"1/2
2303509	IPA9C628-051060	C&G	2"	51,0	-	NPT	2"	51,0	2"
2303511	IPA9C628-076090	C&G	3"	76,0	-	NPT	3"	76,0	3"
2303512	IPA9C628-102114	C&G	4"	102,0	-	NPT	4"	102,0	4"

Dimensions shown may be changed without prior notice

// CAM & GROOVE MIL A-A-59326A / MIL C-27487 - TYPE B**// CAM & GROOVE MIL A-A-59326A / MIL C-27487****Type B - Coupler, BSPT Male - Aluminium**

Item Code	Product Code	Thread type 1	Head DN side 1	Head DN side 1	Thread 1	Thread type 2	Head DN side 2	Head DN side 2	Thread 2
			in	mm			in	mm	
2303239	I5A9C007-013021	C&G	1/2"	13,0	-	BSPT	1/2"	13,0	1/2"
2301847	I5A9C007-019027	C&G	3/4"	19,0	-	BSPT	3/4"	19,0	3/4"
2301848	I5A9C007-025034	C&G	1"	25,0	-	BSPT	1"	25,0	1"
2301849	I5A9C007-032042	C&G	1 1/4"	32,0	-	BSPT	1 1/4"	32,0	1"1/4
2301850	I5A9C007-038049	C&G	1 1/2"	38,0	-	BSPT	1 1/2"	38,0	1"1/2
2301851	I5A9C007-051060	C&G	2"	51,0	-	BSPT	2"	51,0	2"
2301852	I5A9C007-063076	C&G	2 1/2"	63,0	-	BSPT	2 1/2"	63,0	2"1/2
2301853	I5A9C007-076090	C&G	3"	76,0	-	BSPT	3"	76,0	3"
2302699	I5A9C007-102114	C&G	4"	102,0	-	BSPT	4"	102,0	4"
2302700	I5A9C007-127140	C&G	5"	127,0	-	BSPT	5"	127,0	5"
2302701	I5A9C007-152165	C&G	6"	152,0	-	BSPT	6"	152,0	6"

// CAM & GROOVE MIL A-A-59326A / MIL C-27487**Type B - Coupler, BSPT Male - Stainless steel 316**

Item Code	Product Code	Thread type 1	Head DN side 1	Head DN side 1	Thread 1	Thread type 2	Head DN side 2	Head DN side 2	Thread 2
			in	mm			in	mm	
2303241	I3A9C007-013021	C&G	1/2"	13,0	-	BSPT	1/2"	13,0	1/2"
2301765	I3A9C007-019027	C&G	3/4"	19,0	-	BSPT	3/4"	19,0	3/4"
2301854	I3A9C007-025034	C&G	1"	25,0	-	BSPT	1"	25,0	1"
2302593	I3A9C007-032042	C&G	1 1/4"	32,0	-	BSPT	1 1/4"	32,0	1"1/4
2301855	I3A9C007-038049	C&G	1 1/2"	38,0	-	BSPT	1 1/2"	38,0	1"1/2
2301856	I3A9C007-051060	C&G	2"	51,0	-	BSPT	2"	51,0	2"
2302594	I3A9C007-063076	C&G	2 1/2"	63,0	-	BSPT	2 1/2"	63,0	2"1/2
2302595	I3A9C007-076090	C&G	3"	76,0	-	BSPT	3"	76,0	3"
2302596	I3A9C007-102114	C&G	4"	102,0	-	BSPT	4"	102,0	4"
2302597	I3A9C007-152165	C&G	6"	152,0	-	BSPT	6"	152,0	6"

// CAM & GROOVE MIL A-A-59326A / MIL C-27487

Type B - Coupler, BSPT Male - Brass



Item Code	Product Code	Thread type 1	Head DN side 1	Head DN side 1	Thread 1	Thread type 2	Head DN side 2	Head DN side 2	Thread 2
			in	mm			in	mm	
2303240	I8A9C007-013021	C&G	1/2"	13,0	-	BSPT	1/2"	13,0	1/2"
2302779	I8A9C007-019027	C&G	3/4"	19,0	-	BSPT	3/4"	19,0	3/4"
2302780	I8A9C007-025034	C&G	1"	25,0	-	BSPT	1"	25,0	1"
2301857	I8A9C007-032042	C&G	1 1/4"	32,0	-	BSPT	1 1/4"	32,0	1"1/4
2301858	I8A9C007-038049	C&G	1 1/2"	38,0	-	BSPT	1 1/2"	38,0	1"1/2
2302781	I8A9C007-051060	C&G	2"	51,0	-	BSPT	2"	51,0	2"
2302782	I8A9C007-063076	C&G	2 1/2"	63,0	-	BSPT	2 1/2"	63,0	2"1/2
2302783	I8A9C007-076090	C&G	3"	76,0	-	BSPT	3"	76,0	3"
2302784	I8A9C007-102114	C&G	4"	102,0	-	BSPT	4"	102,0	4"

// CAM & GROOVE MIL A-A-59326A / MIL C-27487

Type B - Coupler, BSPT Male - PP



Item Code	Product Code	Thread type 1	Head DN side 1	Head DN side 1	Thread 1	Thread type 2	Head DN side 2	Head DN side 2	Thread 2
			in	mm			in	mm	
2303268	IPA9C007-013021	C&G	1/2"	13,0	-	BSPT	1/2"	13,0	1/2"
2303269	IPA9C007-019027	C&G	3/4"	19,0	-	BSPT	3/4"	19,0	3/4"
2303270	IPA9C007-025034	C&G	1"	25,0	-	BSPT	1"	25,0	1"
2303271	IPA9C007-032042	C&G	1 1/4"	32,0	-	BSPT	1 1/4"	32,0	1"1/4
2303272	IPA9C007-038049	C&G	1 1/2"	38,0	-	BSPT	1 1/2"	38,0	1"1/2
2303273	IPA9C007-051060	C&G	2"	51,0	-	BSPT	2"	51,0	2"
2303275	IPA9C007-076090	C&G	3"	76,0	-	BSPT	3"	76,0	3"
2303276	IPA9C007-102114	C&G	4"	102,0	-	BSPT	4"	102,0	4"

Dimensions shown may be changed without prior notice

// CAM & GROOVE MIL A-A-59326A / MIL C-27487

Type B - Coupler, NPT Male - Aluminium



Item Code	Product Code	Thread type 1	Head DN side 1	Head DN side 1	Thread 1	Thread type 2	Head DN side 2	Head DN side 2	Thread 2
			in	mm			in	mm	
2303522	I5A9C028-013021	C&G	1/2"	13,0	-	NPT	1/2"	13,0	1/2"
2303523	I5A9C028-019027	C&G	3/4"	19,0	-	NPT	3/4"	19,0	3/4"
2303524	I5A9C028-025034	C&G	1"	25,0	-	NPT	1"	25,0	1"
2303525	I5A9C028-032042	C&G	1 1/4"	32,0	-	NPT	1 1/4"	32,0	1"1/4
2303526	I5A9C028-038049	C&G	1 1/2"	38,0	-	NPT	1 1/2"	38,0	1"1/2
2303527	I5A9C028-051060	C&G	2"	51,0	-	NPT	2"	51,0	2"
2303528	I5A9C028-063076	C&G	2 1/2"	63,0	-	NPT	2 1/2"	63,0	2"1/2
2303529	I5A9C028-076090	C&G	3"	76,0	-	NPT	3"	76,0	3"
2303530	I5A9C028-102114	C&G	4"	102,0	-	NPT	4"	102,0	4"
2303531	I5A9C028-127140	C&G	5"	127,0	-	NPT	5"	127,0	5"
2303532	I5A9C028-152165	C&G	6"	152,0	-	NPT	6"	152,0	6"

// CAM & GROOVE MIL A-A-59326A / MIL C-27487

Type B - Coupler, NPT Male - Stainless steel 316



Item Code	Product Code	Thread type 1	Head DN side 1	Head DN side 1	Thread 1	Thread type 2	Head DN side 2	Head DN side 2	Thread 2
			in	mm			in	mm	
2303544	I3A9C028-013021	C&G	1/2"	13,0	-	NPT	1/2"	13,0	1/2"
2303545	I3A9C028-019027	C&G	3/4"	19,0	-	NPT	3/4"	19,0	3/4"
2303546	I3A9C028-025034	C&G	1"	25,0	-	NPT	1"	25,0	1"
2303547	I3A9C028-032042	C&G	1 1/4"	32,0	-	NPT	1 1/4"	32,0	1"1/4
2303548	I3A9C028-038049	C&G	1 1/2"	38,0	-	NPT	1 1/2"	38,0	1"1/2
2303549	I3A9C028-051060	C&G	2"	51,0	-	NPT	2"	51,0	2"
2303550	I3A9C028-063076	C&G	2 1/2"	63,0	-	NPT	2 1/2"	63,0	2"1/2
2303551	I3A9C028-076090	C&G	3"	76,0	-	NPT	3"	76,0	3"
2303552	I3A9C028-102114	C&G	4"	102,0	-	NPT	4"	102,0	4"
2303553	I3A9C028-127140	C&G	5"	127,0	-	NPT	5"	127,0	5"
2303554	I3A9C028-152165	C&G	6"	152,0	-	NPT	6"	152,0	6"

// CAM & GROOVE MIL A-A-59326A / MIL C-27487**Type B - Coupler, NPT Male - Brass**

Item Code	Product Code	Thread type 1	Head DN side 1	Head DN side 1	Thread 1	Thread type 2	Head DN side 2	Head DN side 2	Thread 2
			in	mm			in	mm	
2303533	I8A9C028-013021	C&G	1/2"	13,0	-	NPT	1/2"	13,0	1/2"
2303534	I8A9C028-019027	C&G	3/4"	19,0	-	NPT	3/4"	19,0	3/4"
2303535	I8A9C028-025034	C&G	1"	25,0	-	NPT	1"	25,0	-
2303536	I8A9C028-032042	C&G	1 1/4"	32,0	-	NPT	1 1/4"	32,0	1"1/4
2303537	I8A9C028-038049	C&G	1 1/2"	38,0	-	NPT	1 1/2"	38,0	1"1/2
2303538	I8A9C028-051060	C&G	2"	51,0	-	NPT	2"	51,0	2"
2303539	I8A9C028-063076	C&G	2 1/2"	63,0	-	NPT	2 1/2"	63,0	2"1/2
2303540	I8A9C028-076090	C&G	3"	76,0	-	NPT	3"	76,0	3"
2303541	I8A9C028-102114	C&G	4"	102,0	-	NPT	4"	102,0	4"
2303542	I8A9C028-127140	C&G	5"	127,0	-	NPT	5"	127,0	5"
2303543	I8A9C028-152165	C&G	6"	152,0	-	NPT	6"	152,0	6"

// CAM & GROOVE MIL A-A-59326A / MIL C-27487**Type B - Coupler, NPT Male - PP**

Item Code	Product Code	Thread type 1	Head DN side 1	Head DN side 1	Thread 1	Thread type 2	Head DN side 2	Head DN side 2	Thread 2
			in	mm			in	mm	
2303555	IPA9C028-013021	C&G	1/2"	13,0	-	NPT	1/2"	13,0	1/2"
2303556	IPA9C028-019027	C&G	3/4"	19,0	-	NPT	3/4"	19,0	3/4"
2303557	IPA9C028-025034	C&G	1"	25,0	-	NPT	1"	25,0	-
2303558	IPA9C028-032042	C&G	1 1/4"	32,0	-	NPT	1 1/4"	32,0	1"1/4
2303559	IPA9C028-038049	C&G	1 1/2"	38,0	-	NPT	1 1/2"	38,0	1"1/2
2303560	IPA9C028-051060	C&G	2"	51,0	-	NPT	2"	51,0	2"
2303562	IPA9C028-076090	C&G	3"	76,0	-	NPT	3"	76,0	3"
2303563	IPA9C028-102114	C&G	4"	102,0	-	NPT	4"	102,0	4"

Dimensions shown may be changed without prior notice

// CAM & GROOVE MIL A-A-59326A / MIL C-27487 - TYPE C**// CAM & GROOVE MIL A-A-59326A / MIL C-27487****Type C - Coupler, hose shank - Aluminium**

Item Code	Product Code	Hose ID		Head DN	
		in	mm	in	mm
2303242	I569C200-013013	1/2"	13,0	1/2"	13,0
2301859	I519C200-019019	3/4"	19,0	3/4"	19,0
2300640	I519C200-025025	1"	25,0	1"	25,0
2300641	I519C200-032032	1 1/4"	32,0	1 1/4"	32,0
2301860	I519C200-038038	1 1/2"	38,0	1 1/2"	38,0
2301861	I519C200-051051	2"	51,0	2"	51,0
2301862	I519C200-063063	2 1/2"	63,0	2 1/2"	63,0
2301863	I519C200-076076	3"	76,0	3"	76,0
2301864	I519C200-102102	4"	102,0	4"	102,0
2302679	I519C200-127127	5"	127,0	5"	127,0
2301865	I519C200-152152	6"	152,0	6"	152,0
2303584	I569C200-203203	8"	203,0	8"	203,0

// CAM & GROOVE MIL A-A-59326A / MIL C-27487**Type C - Coupler, hose shank - Stainless steel 316**

Item Code	Product Code	Hose ID		Head DN	
		in	mm	in	mm
2303244	I369C200-013013	1/2"	13,0	1/2"	13,0
2301866	I319C200-019019	3/4"	19,0	3/4"	19,0
2300620	I319C200-025025	1"	25,0	1"	25,0
2300621	I319C200-032032	1 1/4"	32,0	1 1/4"	32,0
2301867	I319C200-038038	1 1/2"	38,0	1 1/2"	38,0
2302448	I319C200-051051	2"	51,0	2"	51,0
2301868	I319C200-063063	2 1/2"	63,0	2 1/2"	63,0
2301869	I319C200-076076	3"	76,0	3"	76,0
2301870	I319C200-102102	4"	102,0	4"	102,0
2303605	I369C200-127127	5"	127,0	5"	127,0
2302449	I319C200-152152	6"	152,0	6"	152,0

// CAM & GROOVE MIL A-A-59326A / MIL C-27487**Type C - Coupler, hose shank - Brass**

Item Code	Product Code	Hose ID	Hose ID	Head DN	Head DN
		in	mm	in	mm
2303243	I869C200-013013	1/2"	13,0	1/2"	13,0
2301871	I819C200-019019	3/4"	19,0	3/4"	19,0
2302759	I819C200-025025	1"	25,0	1"	25,0
2302760	I819C200-032032	1 1/4"	32,0	1 1/4"	32,0
2301872	I819C200-038038	1 1/2"	38,0	1 1/2"	38,0
2301750	I819C200-051051	2"	51,0	2"	51,0
2301873	I819C200-063063	2 1/2"	63,0	2 1/2"	63,0
2301874	I819C200-076076	3"	76,0	3"	76,0
2301875	I819C200-102102	4"	102,0	4"	102,0
2303594	I869C200-127127	5"	127,0	5"	127,0

// CAM & GROOVE MIL A-A-59326A / MIL C-27487**Type C - Coupler, hose shank - PP**

Item Code	Product Code	Hose ID	Hose ID	Head DN	Head DN
		in	mm	in	mm
2303277	IP19C200-013013	1/2"	13,0	1/2"	13,0
2303278	IP19C200-019019	3/4"	19,0	3/4"	19,0
2303279	IP19C200-025025	1"	25,0	1"	25,0
2303280	IP19C200-032032	1 1/4"	32,0	1 1/4"	32,0
2303281	IP19C200-038038	1 1/2"	38,0	1 1/2"	38,0
2303282	IP19C200-051051	2"	51,0	2"	51,0
2303284	IP19C200-076076	3"	76,0	3"	76,0
2303285	IP19C200-102102	4"	102,0	4"	102,0

Dimensions shown may be changed without prior notice

// CAM & GROOVE MIL A-A-59326A / MIL C-27487 - TYPE D

// CAM & GROOVE MIL A-A-59326A / MIL C-27487

Type D - Coupler, BSPP Female - Aluminium



Item Code	Product Code	Thread type 1	Head DN side 1	Head DN side 1	Thread 1	Thread type 2	Head DN side 2	Head DN side 2	Thread 2
			in	mm			in	mm	
2303245	I5A9C806-013021	C&G	1/2"	13,0	-	BSPP	1/2"	13,0	1/2"
2301876	I5A9C806-019027	C&G	3/4"	19,0	-	BSPP	3/4"	19,0	3/4"
2300193	I5A9C806-025034	C&G	1"	25,0	-	BSPP	1"	25,0	1"
2300194	I5A9C806-032042	C&G	1 1/4"	32,0	-	BSPP	1 1/4"	32,0	1"1/4
2301877	I5A9C806-038049	C&G	1 1/2"	38,0	-	BSPP	1 1/2"	38,0	1"1/2
2301878	I5A9C806-051060	C&G	2"	51,0	-	BSPP	2"	51,0	2"
2301879	I5A9C806-063076	C&G	2 1/2"	63,0	-	BSPP	2 1/2"	63,0	2"1/2
2301880	I5A9C806-076090	C&G	3"	76,0	-	BSPP	3"	76,0	3"
2301881	I5A9C806-102114	C&G	4"	102,0	-	BSPP	4"	102,0	4"
2302711	I5A9C806-127140	C&G	5"	127,0	-	BSPP	5"	127,0	5"
2301882	I5A9C806-152165	C&G	6"	152,0	-	BSPP	6"	152,0	6"

// CAM & GROOVE MIL A-A-59326A / MIL C-27487

Type D - Coupler, BSPP Female - Stainless steel 316



Item Code	Product Code	Thread type 1	Head DN side 1	Head DN side 1	Thread 1	Thread type 2	Head DN side 2	Head DN side 2	Thread 2
			in	mm			in	mm	
2303247	I3A9C806-013021	C&G	1/2"	13,0	-	BSPP	1/2"	13,0	1/2"
2301883	I3A9C806-019027	C&G	3/4"	19,0	-	BSPP	3/4"	19,0	3/4"
2300155	I3A9C806-025034	C&G	1"	25,0	-	BSPP	1"	25,0	1"
2300156	I3A9C806-032042	C&G	1 1/4"	32,0	-	BSPP	1 1/4"	32,0	1"1/4
2301884	I3A9C806-038049	C&G	1 1/2"	38,0	-	BSPP	1 1/2"	38,0	1"1/2
2301885	I3A9C806-051060	C&G	2"	51,0	-	BSPP	2"	51,0	2"
2301886	I3A9C806-063076	C&G	2 1/2"	63,0	-	BSPP	2 1/2"	63,0	2"1/2
2301887	I3A9C806-076090	C&G	3"	76,0	-	BSPP	3"	76,0	3"
2302224	I3A9C806-102114	C&G	4"	102,0	-	BSPP	4"	102,0	4"
2302611	I3A9C806-152165	C&G	6"	152,0	-	BSPP	6"	152,0	6"

// CAM & GROOVE MIL A-A-59326A / MIL C-27487**Type D - Coupler, BSPP Female - Brass**

Item Code	Product Code	Thread type 1	Head DN side 1	Head DN side 1	Thread 1	Thread type 2	Head DN side 2	Head DN side 2	Thread 2
			in	mm			in	mm	
2304806	I8A9C806-013021	C&G	1/2"	13,0	-	BSPP	1/2"	13,0	1/2"
2301888	I8A9C806-019027	C&G	3/4"	19,0	-	BSPP	3/4"	19,0	3/4"
2301889	I8A9C806-025034	C&G	1"	25,0	-	BSPP	1"	25,0	1"
2301890	I8A9C806-032042	C&G	1 1/4"	32,0	-	BSPP	1 1/4"	32,0	1"1/4
2301891	I8A9C806-038049	C&G	1 1/2"	38,0	-	BSPP	1 1/2"	38,0	1"1/2
2301892	I8A9C806-051060	C&G	2"	51,0	-	BSPP	2"	51,0	2"
2301893	I8A9C806-063076	C&G	2 1/2"	63,0	-	BSPP	2 1/2"	63,0	2"1/2
2301894	I8A9C806-076090	C&G	3"	76,0	-	BSPP	3"	76,0	3"
2301895	I8A9C806-102114	C&G	4"	102,0	-	BSPP	4"	102,0	4"

// CAM & GROOVE MIL A-A-59326A / MIL C-27487**Type D - Coupler, BSPP Female - PP**

Item Code	Product Code	Thread type 1	Head DN side 1	Head DN side 1	Thread 1	Thread type 2	Head DN side 2	Head DN side 2	Thread 2
			in	mm			in	mm	
2303286	IPA9C806-013021	C&G	1/2"	13,0	-	BSPP	1/2"	13,0	1/2"
2303287	IPA9C806-019027	C&G	3/4"	19,0	-	BSPP	3/4"	19,0	3/4"
2303288	IPA9C806-025034	C&G	1"	25,0	-	BSPP	1"	25,0	1"
2303289	IPA9C806-032042	C&G	1 1/4"	32,0	-	BSPP	1 1/4"	32,0	1"1/4
2303290	IPA9C806-038049	C&G	1 1/2"	38,0	-	BSPP	1 1/2"	38,0	1"1/2
2303291	IPA9C806-051060	C&G	2"	51,0	-	BSPP	2"	51,0	2"
2303293	IPA9C806-076090	C&G	3"	76,0	-	BSPP	3"	76,0	3"
2303294	IPA9C806-102114	C&G	4"	102,0	-	BSPP	4"	102,0	4"

Dimensions shown may be changed without prior notice

// CAM & GROOVE MIL A-A-59326A / MIL C-27487

Type D - Coupler, NPT Female - Aluminium



Item Code	Product Code	Thread type 1	Head DN side 1		Thread 1	Thread type 2	Head DN side 2		Thread 2
			in	mm			in	mm	
2303626	I5A9C828-013021	C&G	1/2"	13,0	-	NPT	1/2"	13,0	1/2"
2303627	I5A9C828-019027	C&G	3/4"	19,0	-	NPT	3/4"	19,0	3/4"
2303628	I5A9C828-025034	C&G	1"	25,0	-	NPT	1"	25,0	1"
2303629	I5A9C828-032042	C&G	1 1/4"	32,0	-	NPT	1 1/4"	32,0	1"1/4
2303630	I5A9C828-038049	C&G	1 1/2"	38,0	-	NPT	1 1/2"	38,0	1"1/2
2303631	I5A9C828-051060	C&G	2"	51,0	-	NPT	2"	51,0	2"
2303632	I5A9C828-063076	C&G	2 1/2"	63,0	-	NPT	2 1/2"	63,0	2"1/2
2303633	I5A9C828-076090	C&G	3"	76,0	-	NPT	3"	76,0	3"
2303634	I5A9C828-102114	C&G	4"	102,0	-	NPT	4"	102,0	4"
2303635	I5A9C828-127140	C&G	5"	127,0	-	NPT	5"	127,0	5"
2303636	I5A9C828-152165	C&G	6"	152,0	-	NPT	6"	152,0	6"
2303637	I5A9C828-203219	C&G	8"	203,0	-	NPT	8"	203,0	8"

// CAM & GROOVE MIL A-A-59326A / MIL C-27487

Type D - Coupler, NPT Female - Stainless steel 316



Item Code	Product Code	Thread type 1	Head DN side 1		Thread 1	Thread type 2	Head DN side 2		Thread 2
			in	mm			in	mm	
2303649	I3A9C828-013021	C&G	1/2"	13,0	-	NPT	1/2"	13,0	1/2"
2303650	I3A9C828-019027	C&G	3/4"	19,0	-	NPT	3/4"	19,0	3/4"
2303651	I3A9C828-025034	C&G	1"	25,0	-	NPT	1"	25,0	1"
2303652	I3A9C828-032042	C&G	1 1/4"	32,0	-	NPT	1 1/4"	32,0	1"1/4
2303653	I3A9C828-038049	C&G	1 1/2"	38,0	-	NPT	1 1/2"	38,0	1"1/2
2303654	I3A9C828-051060	C&G	2"	51,0	-	NPT	2"	51,0	2"
2303655	I3A9C828-063076	C&G	2 1/2"	63,0	-	NPT	2 1/2"	63,0	2"1/2
2303656	I3A9C828-076090	C&G	3"	76,0	-	NPT	3"	76,0	3"
2303657	I3A9C828-102114	C&G	4"	102,0	-	NPT	4"	102,0	4"
2303658	I3A9C828-127140	C&G	5"	127,0	-	NPT	5"	127,0	5"
2303659	I3A9C828-152165	C&G	6"	152,0	-	NPT	6"	152,0	6"

// CAM & GROOVE MIL A-A-59326A / MIL C-27487

Type D - Coupler, NPT Female - Brass



Item Code	Product Code	Thread type 1	Head DN side 1	Head DN side 1	Thread 1	Thread type 2	Head DN side 2	Head DN side 2	Thread 2
			in	mm			in	mm	
2303638	I8A9C828-013021	C&G	1/2"	13,0	-	NPT	1/2"	13,0	1/2"
2303639	I8A9C828-019027	C&G	3/4"	19,0	-	NPT	3/4"	19,0	3/4"
2303640	I8A9C828-025034	C&G	1"	25,0	-	NPT	1"	25,0	1"
2303641	I8A9C828-032042	C&G	1 1/4"	32,0	-	NPT	1 1/4"	32,0	1"1/4
2303642	I8A9C828-038049	C&G	1 1/2"	38,0	-	NPT	1 1/2"	38,0	1"1/2
2303643	I8A9C828-051060	C&G	2"	51,0	-	NPT	2"	51,0	2"
2303644	I8A9C828-063076	C&G	2 1/2"	63,0	-	NPT	2 1/2"	63,0	2"1/2
2303645	I8A9C828-076090	C&G	3"	76,0	-	NPT	3"	76,0	3"
2303646	I8A9C828-102114	C&G	4"	102,0	-	NPT	4"	102,0	4"
2303647	I8A9C828-127140	C&G	5"	127,0	-	NPT	5"	127,0	5"
2303648	I8A9C828-152165	C&G	6"	152,0	-	NPT	6"	152,0	6"

// CAM & GROOVE MIL A-A-59326A / MIL C-27487

Type D - Coupler, NPT Female - PP



Item Code	Product Code	Thread type 1	Head DN side 1	Head DN side 1	Thread 1	Thread type 2	Head DN side 2	Head DN side 2	Thread 2
			in	mm			in	mm	
2303660	IPA9C828-013021	C&G	1/2"	13,0	-	NPT	1/2"	13,0	1/2"
2303661	IPA9C828-019027	C&G	3/4"	19,0	-	NPT	3/4"	19,0	3/4"
2303662	IPA9C828-025034	C&G	1"	25,0	-	NPT	1"	25,0	1"
2303663	IPA9C828-032042	C&G	1 1/4"	32,0	-	NPT	1 1/4"	32,0	1"1/4
2303664	IPA9C828-038049	C&G	1 1/2"	38,0	-	NPT	1 1/2"	38,0	1"1/2
2303665	IPA9C828-051060	C&G	2"	51,0	-	NPT	2"	51,0	2"
2303667	IPA9C828-076090	C&G	3"	76,0	-	NPT	3"	76,0	3"
2303668	IPA9C828-102114	C&G	4"	102,0	-	NPT	4"	102,0	4"

Dimensions shown may be changed without prior notice

// CAM & GROOVE MIL A-A-59326A / MIL C-27487 - TYPE E**// CAM & GROOVE MIL A-A-59326A / MIL C-27487****Type E - Adapter, hose shank - Aluminium**

Item Code	Product Code	Hose ID		Head DN	
		in	mm	in	mm
2303248	I519C100-013013	1/2"	13,0	1/2"	13,0
2302675	I519C100-019019	3/4"	19,0	3/4"	19,0
2300633	I519C100-025025	1"	25,0	1"	25,0
2301736	I519C100-032032	1 1/4"	32,0	1 1/4"	32,0
2301915	I519C100-038038	1 1/2"	38,0	1 1/2"	38,0
2301916	I519C100-051051	2"	51,0	2"	51,0
2302676	I519C100-063063	2 1/2"	63,0	2 1/2"	63,0
2301918	I519C100-076076	3"	76,0	3"	76,0
2302677	I519C100-102102	4"	102,0	4"	102,0
2302678	I519C100-127127	5"	127,0	5"	127,0
2301920	I519C100-152152	6"	152,0	6"	152,0
2303679	I519C100-203203	8"	203,0	8"	203,0

// CAM & GROOVE MIL A-A-59326A / MIL C-27487**Type E - Adapter, hose shank - Stainless steel 316**

Item Code	Product Code	Hose ID		Head DN	
		in	mm	in	mm
2303250	I319C100-013013	1/2"	13,0	1/2"	13,0
2301927	I319C100-019019	3/4"	19,0	3/4"	19,0
2300618	I319C100-025025	1"	25,0	1"	25,0
2301929	I319C100-032032	1 1/4"	32,0	1 1/4"	32,0
2302443	I319C100-038038	1 1/2"	38,0	1 1/2"	38,0
2302444	I319C100-051051	2"	51,0	2"	51,0
2302445	I319C100-063063	2 1/2"	63,0	2 1/2"	63,0
2301931	I319C100-076076	3"	76,0	3"	76,0
2302446	I319C100-102102	4"	102,0	4"	102,0
2303683	I319C100-127127	5"	127,0	5"	127,0
2302447	I319C100-152152	6"	152,0	6"	152,0

// CAM & GROOVE MIL A-A-59326A / MIL C-27487**Type E - Adapter, hose shank - Brass**

Item Code	Product Code	Hose ID		Head DN	
		in	mm	in	mm
2303249	I819C100-013013	1/2"	13,0	1/2"	13,0
2302756	I819C100-019019	3/4"	19,0	3/4"	19,0
2302757	I819C100-025025	1"	25,0	1"	25,0
2301943	I819C100-032032	1 1/4"	32,0	1 1/4"	32,0
2301944	I819C100-038038	1 1/2"	38,0	1 1/2"	38,0
2301749	I819C100-051051	2"	51,0	2"	51,0
2301945	I819C100-063063	2 1/2"	63,0	2 1/2"	63,0
2301946	I819C100-076076	3"	76,0	3"	76,0
2301947	I819C100-102102	4"	102,0	4"	102,0
2303681	I819C100-127127	5"	127,0	5"	127,0
2302758	I819C100-152152	6"	152,0	6"	152,0

// CAM & GROOVE MIL A-A-59326A / MIL C-27487**Type E - Adapter, hose shank - PP**

Item Code	Product Code	Hose ID		Head DN	
		in	mm	in	mm
2303295	IP19C100-013013	1/2"	13,0	1/2"	13,0
2303296	IP19C100-019019	3/4"	19,0	3/4"	19,0
2303297	IP19C100-025025	1"	25,0	1"	25,0
2303298	IP19C100-032032	1 1/4"	32,0	1 1/4"	32,0
2303299	IP19C100-038038	1 1/2"	38,0	1 1/2"	38,0
2303300	IP19C100-051051	2"	51,0	2"	51,0
2303302	IP19C100-076076	3"	76,0	3"	76,0
2303303	IP19C100-102102	4"	102,0	4"	102,0

Dimensions shown may be changed without prior notice

// CAM & GROOVE MIL A-A-59326A / MIL C-27487 - TYPE F

// CAM & GROOVE MIL A-A-59326A / MIL C-27487

Type F - Adapter, BSPT Male - Aluminium



Item Code	Product Code	Thread type 1	Head DN side 1	Head DN side 1	Thread 1	Thread type 2	Head DN side 2	Head DN side 2	Thread 2
			in	mm			in	mm	
2303251	I5A9C507-013021	C&G	1/2"	13,0	-	BSPT	1/2"	13,0	1/2"
2301948	I5A9C507-019027	C&G	3/4"	19,0	-	BSPT	3/4"	19,0	3/4"
2301949	I5A9C507-025034	C&G	1"	25,0	-	BSPT	1"	25,0	1"
2301950	I5A9C507-032042	C&G	1 1/4"	32,0	-	BSPT	1 1/4"	32,0	1"1/4
2301951	I5A9C507-038049	C&G	1 1/2"	38,0	-	BSPT	1 1/2"	38,0	1"1/2
2301952	I5A9C507-051060	C&G	2"	51,0	-	BSPT	2"	51,0	2"
2301953	I5A9C507-063076	C&G	2 1/2"	63,0	-	BSPT	2 1/2"	63,0	2"1/2
2301954	I5A9C507-076090	C&G	3"	76,0	-	BSPT	3"	76,0	3"
2301955	I5A9C507-102114	C&G	4"	102,0	-	BSPT	4"	102,0	4"
2302703	I5A9C507-127140	C&G	5"	127,0	-	BSPT	5"	127,0	5"
2302704	I5A9C507-152165	C&G	6"	152,0	-	BSPT	6"	152,0	6"

// CAM & GROOVE MIL A-A-59326A / MIL C-27487

Type F - Adapter, BSPT Male - Stainless steel 316



Item Code	Product Code	Thread type 1	Head DN side 1	Head DN side 1	Thread 1	Thread type 2	Head DN side 2	Head DN side 2	Thread 2
			in	mm			in	mm	
2303253	I3A9C507-013021	C&G	1/2"	13,0	-	BSPT	1/2"	13,0	1/2"
2301956	I3A9C507-019027	C&G	3/4"	19,0	-	BSPT	3/4"	19,0	3/4"
2301957	I3A9C507-025034	C&G	1"	25,0	-	BSPT	1"	25,0	1"
2301958	I3A9C507-032042	C&G	1 1/4"	32,0	-	BSPT	1 1/4"	32,0	1"1/4
2302598	I3A9C507-038049	C&G	1 1/2"	38,0	-	BSPT	1 1/2"	38,0	1"1/2
2301960	I3A9C507-051060	C&G	2"	51,0	-	BSPT	2"	51,0	2"
2301961	I3A9C507-063076	C&G	2 1/2"	63,0	-	BSPT	2 1/2"	63,0	2"1/2
2302599	I3A9C507-076090	C&G	3"	76,0	-	BSPT	3"	76,0	3"
2302600	I3A9C507-102114	C&G	4"	102,0	-	BSPT	4"	102,0	4"
2302601	I3A9C507-152165	C&G	6"	152,0	-	BSPT	6"	152,0	6"

// CAM & GROOVE MIL A-A-59326A / MIL C-27487

Type F - Adapter, BSPT Male - Brass



Item Code	Product Code	Thread type 1	Head DN side 1	Head DN side 1	Thread 1	Thread type 2	Head DN side 2	Head DN side 2	Thread 2
			in	mm			in	mm	
2303252	I8A9C507-013021	C&G	1/2"	13,0	-	BSPT	1/2"	13,0	1/2"
2302785	I8A9C507-019027	C&G	3/4"	19,0	-	BSPT	3/4"	19,0	3/4"
2302786	I8A9C507-025034	C&G	1"	25,0	-	BSPT	1"	25,0	1"
2302787	I8A9C507-032042	C&G	1 1/4"	32,0	-	BSPT	1 1/4"	32,0	1"1/4
2301962	I8A9C507-038049	C&G	1 1/2"	38,0	-	BSPT	1 1/2"	38,0	1"1/2
2301963	I8A9C507-051060	C&G	2"	51,0	-	BSPT	2"	51,0	2"
2301964	I8A9C507-063076	C&G	2 1/2"	63,0	-	BSPT	2 1/2"	63,0	2"1/2
2301965	I8A9C507-076090	C&G	3"	76,0	-	BSPT	3"	76,0	3"
2302788	I8A9C507-102114	C&G	4"	102,0	-	BSPT	4"	102,0	4"

// CAM & GROOVE MIL A-A-59326A / MIL C-27487

Type F - Adapter, BSPT Male - PP



Item Code	Product Code	Thread type 1	Head DN side 1	Head DN side 1	Thread 1	Thread type 2	Head DN side 2	Head DN side 2	Thread 2
			in	mm			in	mm	
2303304	IPA9C507-013021	C&G	1/2"	13,0	-	BSPT	1/2"	13,0	1/2"
2303305	IPA9C507-019027	C&G	3/4"	19,0	-	BSPT	3/4"	19,0	3/4"
2303306	IPA9C507-025034	C&G	1"	25,0	-	BSPT	1"	25,0	1"
2303307	IPA9C507-032042	C&G	1 1/4"	32,0	-	BSPT	1 1/4"	32,0	1"1/4
2303308	IPA9C507-038049	C&G	1 1/2"	38,0	-	BSPT	1 1/2"	38,0	1"1/2
2303309	IPA9C507-051060	C&G	2"	51,0	-	BSPT	2"	51,0	2"
2303311	IPA9C507-076090	C&G	3"	76,0	-	BSPT	3"	76,0	3"
2303312	IPA9C507-102114	C&G	4"	102,0	-	BSPT	4"	102,0	4"

Dimensions shown may be changed without prior notice

// CAM & GROOVE MIL A-A-59326A / MIL C-27487

Type F - Adapter, NPT Male - Aluminium



Item Code	Product Code	Thread type 1	Head DN side 1	Head DN side 1	Thread 1	Thread type 2	Head DN side 2	Head DN side 2	Thread 2
			in	mm			in	mm	
2303702	I5A9C528-013021	C&G	1/2"	13,0	-	NPT	1/2"	13,0	1/2"
2303703	I5A9C528-019027	C&G	3/4"	19,0	-	NPT	3/4"	19,0	3/4"
2303704	I5A9C528-025034	C&G	1"	25,0	-	NPT	1"	25,0	1"
2303705	I5A9C528-032042	C&G	1 1/4"	32,0	-	NPT	1 1/4"	32,0	1"1/4
2303706	I5A9C528-038049	C&G	1 1/2"	38,0	-	NPT	1 1/2"	38,0	1"1/2
2303707	I5A9C528-051060	C&G	2"	51,0	-	NPT	2"	51,0	2"
2303708	I5A9C528-063076	C&G	2 1/2"	63,0	-	NPT	2 1/2"	63,0	2"1/2
2303709	I5A9C528-076090	C&G	3"	76,0	-	NPT	3"	76,0	3"
2303710	I5A9C528-102114	C&G	4"	102,0	-	NPT	4"	102,0	4"
2303711	I5A9C528-127140	C&G	5"	127,0	-	NPT	5"	127,0	5"
2303712	I5A9C528-152165	C&G	6"	152,0	-	NPT	6"	152,0	6"
2303713	I5A9C528-203219	C&G	8"	203,0	-	NPT	8"	203,0	8"

// CAM & GROOVE MIL A-A-59326A / MIL C-27487

Type F - Adapter, NPT Male - Stainless steel 316



Item Code	Product Code	Thread type 1	Head DN side 1	Head DN side 1	Thread 1	Thread type 2	Head DN side 2	Head DN side 2	Thread 2
			in	mm			in	mm	
2303725	I3A9C528-013021	C&G	1/2"	13,0	-	NPT	1/2"	13,0	1/2"
2303726	I3A9C528-019027	C&G	3/4"	19,0	-	NPT	3/4"	19,0	3/4"
2303727	I3A9C528-025034	C&G	1"	25,0	-	NPT	1"	25,0	1"
2303728	I3A9C528-032042	C&G	1 1/4"	32,0	-	NPT	1 1/4"	32,0	1"1/4
2303729	I3A9C528-038049	C&G	1 1/2"	38,0	-	NPT	1 1/2"	38,0	1"1/2
2303730	I3A9C528-051060	C&G	2"	51,0	-	NPT	2"	51,0	2"
2303731	I3A9C528-063076	C&G	2 1/2"	63,0	-	NPT	2 1/2"	63,0	2"1/2
2303732	I3A9C528-076090	C&G	3"	76,0	-	NPT	3"	76,0	3"
2303733	I3A9C528-102114	C&G	4"	102,0	-	NPT	4"	102,0	4"
2303734	I3A9C528-127140	C&G	5"	127,0	-	NPT	5"	127,0	5"
2303735	I3A9C528-152165	C&G	6"	152,0	-	NPT	6"	152,0	6"

// CAM & GROOVE MIL A-A-59326A / MIL C-27487

Type F - Adapter, NPT Male - Brass



Item Code	Product Code	Thread type 1	Head DN side 1	Head DN side 1	Thread 1	Thread type 2	Head DN side 2	Head DN side 2	Thread 2
			in	mm			in	mm	
2303714	I8A9C528-013021	C&G	1/2"	13,0	-	NPT	1/2"	13,0	1/2"
2303715	I8A9C528-019027	C&G	3/4"	19,0	-	NPT	3/4"	19,0	3/4"
2303716	I8A9C528-025034	C&G	1"	25,0	-	NPT	1"	25,0	1"
2303717	I8A9C528-032042	C&G	1 1/4"	32,0	-	NPT	1 1/4"	32,0	1"1/4
2303718	I8A9C528-038049	C&G	1 1/2"	38,0	-	NPT	1 1/2"	38,0	1"1/2
2303719	I8A9C528-051060	C&G	2"	51,0	-	NPT	2"	51,0	2"
2303720	I8A9C528-063076	C&G	2 1/2"	63,0	-	NPT	2 1/2"	63,0	2"1/2
2303721	I8A9C528-076090	C&G	3"	76,0	-	NPT	3"	76,0	3"
2303722	I8A9C528-102114	C&G	4"	102,0	-	NPT	4"	102,0	4"
2303723	I8A9C528-127140	C&G	5"	127,0	-	NPT	5"	127,0	5"
2303724	I8A9C528-152165	C&G	6"	152,0	-	NPT	6"	152,0	6"

// CAM & GROOVE MIL A-A-59326A / MIL C-27487

Type F - Adapter, NPT Male - PP



Item Code	Product Code	Thread type 1	Head DN side 1	Head DN side 1	Thread 1	Thread type 2	Head DN side 2	Head DN side 2	Thread 2
			in	mm			in	mm	
2303736	IPA9C528-013021	C&G	1/2"	13,0	-	NPT	1/2"	13,0	1/2"
2303737	IPA9C528-019027	C&G	3/4"	19,0	-	NPT	3/4"	19,0	3/4"
2303738	IPA9C528-025034	C&G	1"	25,0	-	NPT	1"	25,0	1"
2303739	IPA9C528-032042	C&G	1 1/4"	32,0	-	NPT	1 1/4"	32,0	1"1/4
2303740	IPA9C528-038049	C&G	1 1/2"	38,0	-	NPT	1 1/2"	38,0	1"1/2
2303741	IPA9C528-051060	C&G	2"	51,0	-	NPT	2"	51,0	2"
2303743	IPA9C528-076090	C&G	3"	76,0	-	NPT	3"	76,0	3"
2303744	IPA9C528-102114	C&G	4"	102,0	-	NPT	4"	102,0	4"

Dimensions shown may be changed without prior notice

// CAM & GROOVE MIL A-A-59326A / MIL C-27487 - TYPE DC**// CAM & GROOVE MIL A-A-59326A / MIL C-27487****Type DC - Female dust cap for adapter - Aluminium**

Item Code	Product Code	Thread type 1	Head DN side 1	Head DN side 1	Thread 1
			in	mm	in
2303254	I5A9C900-013	C&G	1/2"	13,0	-
2301967	I5A9C900-019	C&G	3/4"	19,0	-
2300200	I5A9C900-025	C&G	1"	25,0	-
2300201	I5A9C900-032	C&G	1 1/4"	32,0	-
2301968	I5A9C900-038	C&G	1 1/2"	38,0	-
2301969	I5A9C900-051	C&G	2"	51,0	-
2301970	I5A9C900-063	C&G	2 1/2"	63,0	-
2301971	I5A9C900-076	C&G	3"	76,0	-
2301972	I5A9C900-102	C&G	4"	102,0	-
2302712	I5A9C900-127	C&G	5"	127,0	-
2302713	I5A9C900-152	C&G	6"	152,0	-
2303756	I5A9C900-203	C&G	8"	203,0	-

// CAM & GROOVE MIL A-A-59326A / MIL C-27487**Type DC - Female dust cap for adapter - Stainless steel 316**

Item Code	Product Code	Thread type 1	Head DN side 1	Head DN side 1	Thread 1
			in	mm	in
2303256	I3A9C900-013	C&G	1/2"	13,0	-
2301973	I3A9C900-019	C&G	3/4"	19,0	-
2301546	I3A9C900-025	C&G	1"	25,0	-
2302612	I3A9C900-032	C&G	1 1/4"	32,0	-
2302613	I3A9C900-038	C&G	1 1/2"	38,0	-
2302225	I3A9C900-051	C&G	2"	51,0	-
2302614	I3A9C900-063	C&G	2 1/2"	63,0	-
2302615	I3A9C900-076	C&G	3"	76,0	-
2302616	I3A9C900-102	C&G	4"	102,0	-
2303761	I3A9C900-127	C&G	5"	127,0	-
2302617	I3A9C900-152	C&G	6"	152,0	-

// CAM & GROOVE MIL A-A-59326A / MIL C-27487**Type DC - Female dust cap for adapter - Brass**

Item Code	Product Code	Thread type 1	Head DN side 1	Head DN side 1	Thread 1
			in	mm	in
2303255	I8A9C900-013	C&G	1/2"	13,0	-
2302797	I8A9C900-019	C&G	3/4"	19,0	-
2302798	I8A9C900-025	C&G	1"	25,0	-
2302799	I8A9C900-032	C&G	1 1/4"	32,0	-
2302800	I8A9C900-038	C&G	1 1/2"	38,0	-
2302226	I8A9C900-051	C&G	2"	51,0	-
2302801	I8A9C900-063	C&G	2 1/2"	63,0	-
2302227	I8A9C900-076	C&G	3"	76,0	-
2302802	I8A9C900-102	C&G	4"	102,0	-
2303758	I8A9C900-127	C&G	5"	127,0	-
2303759	I8A9C900-152	C&G	6"	152,0	-

// CAM & GROOVE MIL A-A-59326A / MIL C-27487**Type DC - Female dust cap for adapter - PP**

Item Code	Product Code	Thread type 1	Head DN side 1	Head DN side 1	Thread 1
			in	mm	in
2303313	IPA9C900-013	C&G	1/2"	13,0	-
2303314	IPA9C900-019	C&G	3/4"	19,0	-
2303315	IPA9C900-025	C&G	1"	25,0	-
2303318	IPA9C900-051	C&G	2"	51,0	-
2303320	IPA9C900-076	C&G	3"	76,0	-
2303321	IPA9C900-102	C&G	4"	102,0	-

Dimensions shown may be changed without prior notice

// CAM & GROOVE MIL A-A-59326A / MIL C-27487 - TYPE DP**// CAM & GROOVE MIL A-A-59326A / MIL C-27487****Type DP - Male dust plug for coupler - Aluminium**

Item Code	Product Code	Thread type 1	Head DN side 1	Head DN side 1	Thread 1
			in	mm	in
2303257	I5A9C700-013	C&G	1/2"	13,0	-
2301979	I5A9C700-019	C&G	3/4"	19,0	-
2300967	I5A9C700-025	C&G	1"	25,0	-
2302707	I5A9C700-032	C&G	1 1/4"	32,0	-
2301982	I5A9C700-038	C&G	1 1/2"	38,0	-
2301983	I5A9C700-051	C&G	2"	51,0	-
2301985	I5A9C700-063	C&G	2 1/2"	63,0	-
2301986	I5A9C700-076	C&G	3"	76,0	-
2302708	I5A9C700-102	C&G	4"	102,0	-
2302709	I5A9C700-127	C&G	5"	127,0	-
2301988	I5A9C700-152	C&G	6"	152,0	-

// CAM & GROOVE MIL A-A-59326A / MIL C-27487**Type DP - Male dust plug for coupler - Stainless steel 316**

Item Code	Product Code	Thread type 1	Head DN side 1	Head DN side 1	Thread 1
			in	mm	in
2303237	I3A9C700-013	C&G	1/2"	13,0	-
2302605	I3A9C700-019	C&G	3/4"	19,0	-
2302606	I3A9C700-025	C&G	1"	25,0	-
2302607	I3A9C700-032	C&G	1 1/4"	32,0	-
2301746	I3A9C700-038	C&G	1 1/2"	38,0	-
2302608	I3A9C700-051	C&G	2"	51,0	-
2301989	I3A9C700-063	C&G	2 1/2"	63,0	-
2301747	I3A9C700-076	C&G	3"	76,0	-
2302609	I3A9C700-102	C&G	4"	102,0	-
2302610	I3A9C700-152	C&G	6"	152,0	-

// CAM & GROOVE MIL A-A-59326A / MIL C-27487**Type DP - Male dust plug for coupler - Brass**

Item Code	Product Code	Thread type 1	Head DN side 1	Head DN side 1	Thread 1
			in	mm	in
2303258	I8A9C700-013	C&G	1/2"	13,0	-
2302792	I8A9C700-019	C&G	3/4"	19,0	-
2302793	I8A9C700-025	C&G	1"	25,0	-
2302794	I8A9C700-032	C&G	1 1/4"	32,0	-
2302795	I8A9C700-038	C&G	1 1/2"	38,0	-
2302228	I8A9C700-051	C&G	2"	51,0	-
2302229	I8A9C700-063	C&G	2 1/2"	63,0	-
2302230	I8A9C700-076	C&G	3"	76,0	-
2302231	I8A9C700-102	C&G	4"	102,0	-
2302796	I8A9C700-127	C&G	5"	127,0	-
2303782	I8A9C700-152	C&G	6"	152,0	-

// CAM & GROOVE MIL A-A-59326A / MIL C-27487**Type DP - Male dust plug for coupler - PP**

Item Code	Product Code	Thread type 1	Head DN side 1	Head DN side 1	Thread 1
			in	mm	in
2303322	IPA9C700-013	C&G	1/2"	13,0	-
2303323	IPA9C700-019	C&G	3/4"	19,0	-
2303324	IPA9C700-025	C&G	1"	25,0	-
2303325	IPA9C700-032	C&G	1 1/4"	32,0	-
2303326	IPA9C700-038	C&G	1 1/2"	38,0	-
2303327	IPA9C700-051	C&G	2"	51,0	-
2303329	IPA9C700-076	C&G	3"	76,0	-
2303330	IPA9C700-102	C&G	4"	102,0	-

Dimensions shown may be changed without prior notice

// CAM & GROOVE EN 14 420-7 / DIN 2828 - TYPE A**// CAM & GROOVE EN 14 420-7 / DIN 2828****Type AF - Adapter, BSPP Female - PTFE Seal - Stainless steel 316**

Item Code	Product Code	Thread type 1	Head DN side 1	Head DN side 1	Thread 1	Thread type 2	Head DN side 2	Head DN side 2	Thread 2
			in	mm			in	mm	
2306724	I3A9G606-013021	C&G DIN	1/2"	13,0	-	BSPP	1/2"	13,0	1/2"
2302618	I3A9G606-020027	C&G DIN	3/4"	19,0	-	BSPP	3/4"	19,0	3/4"
2302619	I3A9G606-025034	C&G DIN	1"	25,0	-	BSPP	1"	25,0	1"
2302620	I3A9G606-032042	C&G DIN	1 1/4"	32,0	-	BSPP	1 1/4"	32,0	1"1/4
2302621	I3A9G606-040049	C&G DIN	1 1/2"	38,0	-	BSPP	1 1/2"	38,0	1"1/2
2302622	I3A9G606-050060	C&G DIN	2"	51,0	-	BSPP	2"	51,0	2"
2302623	I3A9G606-065076	C&G DIN	2 1/2"	63,0	-	BSPP	2 1/2"	63,0	2"1/2
2302624	I3A9G606-080090	C&G DIN	3"	76,0	-	BSPP	3"	76,0	3"
2302625	I3A9G606-100114	C&G DIN	4"	102,0	-	BSPP	4"	102,0	4"

// CAM & GROOVE EN 14 420-7 / DIN 2828 - TYPE C**// CAM & GROOVE EN 14 420-7 / DIN 2828****Type CC - Coupler, EN 14 420-2 / DIN 2817 hose shank - Stainless steel 316**

Item Code	Product Code	Hose ID	Hose ID	Head DN	Head DN
		in	mm	in	mm
2302522	I349G200-020020	13/16"	20,0	3/4"	19,0
2302523	I349G200-025025	1"	25,0	1"	25,0
2302524	I349G200-032032	1 1/4"	32,0	1 1/4"	32,0
2302525	I349G200-038040	1 1/2"	38,0	1 1/2"	38,0
2302099	I349G200-051050	2"	50,0	2"	51,0
2302526	I349G200-065065	2 9/16"	65,0	2 1/2"	63,0
2302527	I349G200-076080	3"	75,0	3"	76,0
2302528	I349G200-102100	4"	100,0	4"	102,0

To assemble the insert, use "Safety clamps EN 14 420-3 / DIN 2817" and "Safety clamps flexoline®": consult chapter "Clamps"

// CAM & GROOVE EN 14 420-7 / DIN 2828 - TYPE D**// CAM & GROOVE EN 14 420-7 / DIN 2828****Type DF - Coupler, BSPP Female - PTFE Seal - Stainless steel 316**

Item Code	Product Code	Thread type 1	Head DN side 1	Head DN side 1	Thread 1	Thread type 2	Head DN side 2	Head DN side 2	Thread 2
			in	mm			in	mm	
2306723	I3A9G806-013021	C&G DIN	1/2"	13,0	-	BSPP	1/2"	13,0	1/2"
2302626	I3A9G806-020027	C&G DIN	3/4"	19,0	-	BSPP	3/4"	19,0	3/4"
2302627	I3A9G806-025034	C&G DIN	1"	25,0	-	BSPP	1"	25,0	1"
2302628	I3A9G806-032042	C&G DIN	1 1/4"	32,0	-	BSPP	1 1/4"	32,0	1"1/4
2302629	I3A9G806-040049	C&G DIN	1 1/2"	38,0	-	BSPP	1 1/2"	38,0	1"1/2
2302630	I3A9G806-050060	C&G DIN	2"	51,0	-	BSPP	2"	51,0	2"
2302631	I3A9G806-065076	C&G DIN	2 1/2"	63,0	-	BSPP	2 1/2"	63,0	2"1/2
2302632	I3A9G806-080090	C&G DIN	3"	76,0	-	BSPP	3"	76,0	3"
2302633	I3A9G806-100114	C&G DIN	4"	102,0	-	BSPP	4"	102,0	4"

// CAM & GROOVE EN 14 420-7 / DIN 2828 - TYPE E**// CAM & GROOVE EN 14 420-7 / DIN 2828****Type EE - Adapter, EN 14 420-2 / DIN 2817 hose shank - Stainless steel 316**

Item Code	Product Code	Hose ID	Hose ID	Head DN	Head DN
		in	mm	in	mm
2302514	I349G100-020020	13/16"	20,0	3/4"	19,0
2302515	I349G100-025025	1"	25,0	1"	25,0
2302516	I349G100-032032	1 1/4"	32,0	1 1/4"	32,0
2302517	I349G100-038040	1 1/2"	38,0	1 1/2"	38,0
2302518	I349G100-051050	2"	50,0	2"	51,0
2302519	I349G100-065065	2 9/16"	65,0	2 1/2"	63,0
2302520	I349G100-076080	3"	75,0	3"	76,0
2302521	I349G100-102100	4"	100,0	4"	102,0

To assemble the insert, use "Safety clamps EN 14 420-3 / DIN 2817" and "Safety clamps Flexoline®": consult chapter "Clamps"

Dimensions shown may be changed without prior notice

// CAM & GROOVE - SEAL**// CAM & GROOVE - SEAL**

Seal - NBR



Item Code	Product Code	DN	DN
		mm	in
2303238	INJ09C-013	13	1/2"
2301991	INJ09C-019	19	3/4"
2300492	INJ09C-025	25	1"
2300493	INJ09C-032	32	1 1/4"
2302863	INJ09C-038	38	1 1/2"
2301993	INJ09C-051	51	2"
2302864	INJ09C-063	63	2 1/2"
2301995	INJ09C-076	76	3"
2301997	INJ09C-102	102	4"
2302865	INJ09C-127	125	5"
2301998	INJ09C-152	152	6"

// CAM & GROOVE - SEAL

Seal - FKM/FPM



Item Code	Product Code	DN	DN
		mm	in
2306104	IJJ09C-013	13	1/2"
2305621	IJJ09C-019	19	3/4"
2300470	IJJ09C-025	25	1"
2306105	IJJ09C-032	32	1 1/4"
2303152	IJJ09C-038	38	1 1/2"
2303153	IJJ09C-051	51	2"
2303154	IJJ09C-063	63	2 1/2"
2303155	IJJ09C-076	76	3"
2303156	IJJ09C-102	102	4"

// CAM & GROOVE - SEAL

Seal - Closed envelope - PTFE



Item Code	Product Code	DN	DN
		mm	in
2302004	ITJM9C-038	38	1 1/2"
2302005	ITJM9C-051	51	2"
2302888	ITJM9C-076	76	3"
2302889	ITJM9C-102	102	4"

// CAM & GROOVE - ACCESSORY

// CAM & GROOVE - ACCESSORY

Handle, Ring & Pin - Stainless steel 316



Item Code	Product Code	DN	DN (min)	DN (max)	Technical Note
		in	mm	mm	
2302672	I3Y9C001	1/2" - 3/4"	13	19	-
2302673	I3Y9C002	1"	25	25	-
2302232	I3Y9C003	1 1/4" - 2 1/2"	32	63	-
2301677	I3Y9C004	3" - 5"	76	127	-
2302674	I3Y9C005	6"	152	152	-



// COMBINATION NIPPLE

// COMBINATION NIPPLE FOR CLAMPING.....	248
// ALFACRIMP COMBINATION NIPPLE.....	250

// COMBINATION NIPPLE FOR CLAMPING

// COMBINATION NIPPLE FOR CLAMPING

BSPT Male - Hose shank for clamping - Plated steel



Item Code	Product Code	Hose ID	Hose ID	Thread type	Thread
		in	mm		in
2303820	I1607100-013021	1/2"	13,0	BSPT	1/2"
2303821	I1607100-019027	3/4"	19,0	BSPT	3/4"
2303822	I1607100-025034	1"	25,0	BSPT	1"
2303823	I1607100-032042	1 1/4"	32,0	BSPT	1"1/4
2303824	I1607100-038049	1 1/2"	38,0	BSPT	1"1/2
2303825	I1607100-051060	2"	51,0	BSPT	2"
2303826	I1607100-063076	2 1/2"	63,0	BSPT	2"1/2
2303827	I1607100-076090	3"	76,0	BSPT	3"
2303828	I1607100-102114	4"	102,0	BSPT	4"
2306051	I1607100-127140	5"	127,0	BSPT	5"
2303829	I1607100-152165	6"	152,0	BSPT	6"

Combination nipple in S/S available on request

// COMBINATION NIPPLE FOR CLAMPING

NPT Male - Hose shank for clamping - Plated steel



Item Code	Product Code	Hose ID	Hose ID	Thread type	Thread
		in	mm		in
2303830	I1628100-013021	1/2"	13,0	NPT	1/2"
2303831	I1628100-019027	3/4"	19,0	NPT	3/4"
2303832	I1628100-025034	1"	25,0	NPT	1"
2303833	I1628100-032042	1 1/4"	32,0	NPT	1"1/4
2303834	I1628100-038049	1 1/2"	38,0	NPT	1"1/2
2303835	I1628100-051060	2"	51,0	NPT	2"
2303836	I1628100-063076	2 1/2"	63,0	NPT	2"1/2
2303837	I1628100-076090	3"	76,0	NPT	3"
2303838	I1628100-102114	4"	102,0	NPT	4"
2303839	I1628100-127140	5"	127,0	NPT	5"
2303840	I1628100-152165	6"	152,0	NPT	6"
2303841	I1628100-203219	8"	203,0	NPT	8"

Combination nipple in S/S available on request

Dimensions shown may be changed without prior notice

// HOSE MENDER**Hose shank for clamping - Plated steel**

Item Code	Product Code	Hose ID	
		in	mm
2303878	I1656100-013013	1/2"	13,0
2303879	I1656100-019019	3/4"	19,0
2303880	I1656100-025025	1"	25,0
2303881	I1656100-032032	1 1/4"	32,0
2303882	I1656100-038038	1 1/2"	38,0
2303883	I1656100-051051	2"	51,0
2303884	I1656100-063063	2 1/2"	63,0
2303885	I1656100-076076	3"	76,0
2303886	I1656100-102102	4"	102,0
2303887	I1656100-127127	5"	127,0
2303888	I1656100-152152	6"	152,0
2303889	I1656100-203203	8"	203,0

// ALFACRIMP COMBINATION NIPPLE

// ALFACRIMP COMBINATION NIPPLE

BSPT Male complete with pre-crimped ferrule - Plated steel



Item Code	Product Code	Hose ID	Hose ID	Thread type	Thread	Hose OD (min)	Hose OD (max)
		in	mm		in	mm	mm
2307175	I1707M0S-076090	3"	76,0	BSPT	3"	86,0	96,0
2302324	I1707M00-076090	3"	76,0	BSPT	3"	88,0	102,0
2307176	I1707M0S-102114	4"	102,0	BSPT	4"	112,0	122,0
2302325	I1707M00-102114	4"	102,0	BSPT	4"	114,0	128,0
2307177	I1707M0S-127140	5"	127,0	BSPT	5"	139,0	147,0
2302326	I1707M00-127140	5"	127,0	BSPT	5"	139,0	153,0
2307178	I1707M0S-152165	6"	152,0	BSPT	6"	164,0	172,0
2302007	I1707M00-152165	6"	152,0	BSPT	6"	166,0	184,0

For BSPT male with serrated hose shank for crimping ferrule and DN<76 mm. Consult ALFAGOMMA hydraulic catalogue.

// ALFACRIMP COMBINATION NIPPLE

BSPT Male complete with pre-crimped ferrule - Stainless steel 316



Item Code	Product Code	Hose ID	Hose ID	Thread type	Thread	Hose OD (min)	Hose OD (max)
		in	mm		in	mm	mm
2307188	I3707M00-076090	3"	76,0	BSPT	3"	88,0	102,0
2307190	I3707M00-102114	4"	102,0	BSPT	4"	114,0	128,0
2307192	I3707M00-127140	5"	127,0	BSPT	5"	139,0	153,0
2307194	I3707M00-152165	6"	152,0	BSPT	6"	166,0	184,0

Dimensions shown may be changed without prior notice

// ALFACRIMP COMBINATION NIPPLE**NPT Male complete with pre-cripped ferrule - Plated steel**

Item Code	Product Code	Hose ID	Hose ID	Thread type	Thread	Hose OD (min)	Hose OD (max)
		in	mm		in	mm	mm
2307179	I1728M0S-076090	3"	76,0	NPT	3"	86,0	96,0
2302332	I1728M00-076090	3"	76,0	NPT	3"	88,0	102,0
2307180	I1728M0S-102114	4"	102,0	NPT	4"	112,0	122,0
2302333	I1728M00-102114	4"	102,0	NPT	4"	114,0	128,0
2307181	I1728M0S-127140	5"	127,0	NPT	5"	139,0	147,0
2302334	I1728M00-127140	5"	127,0	NPT	5"	139,0	153,0
2307182	I1728M0S-152165	6"	152,0	NPT	6"	166,0	172,0
2302335	I1728M00-152165	6"	152,0	NPT	6"	166,0	184,0

For NPT male with serrated hose shank for crimping ferrule and DN<76 mm. Consult ALFAGOMMA hydraulic catalogue.

// ALFACRIMP COMBINATION NIPPLE**NPT Male complete with pre-cripped ferrule - Stainless steel 316**

Item Code	Product Code	Hose ID	Hose ID	Thread type	Thread	Hose OD (min)	Hose OD (max)
		in	mm		in	mm	mm
2307196	I3728M00-076090	3"	76,0	NPT	3"	88,0	102,0
2307198	I3728M00-102114	4"	102,0	NPT	4"	114,0	128,0
2307200	I3728M00-127140	5"	127,0	NPT	5"	139,0	153,0
2307202	I3728M00-152165	6"	152,0	NPT	6"	166,0	184,0



// EN 14 420-5 / DIN 2817

// EN 14 420-5 / DIN 2817 - HOSE SHANK.....253

Dimensions shown may be changed without prior notice

// EN 14 420-5 / DIN 2817 - HOSE SHANK**// EN 14 420-5 / DIN 2817****BSPP Male - EN 14 420-2 / DIN 2817 hose shank - Stainless steel 316**

Item Code	Product Code	Hose ID	Hose ID	Thread type	Thread
		in	mm		in
2302501	I3406100-013021	1/2"	13,0	BSPP	1/2"
2302502	I3406100-019027	3/4"	19,0	BSPP	3/4"
2302503	I3406100-025034	1"	25,0	BSPP	1"
2301771	I3406100-032042	1 1/4"	32,0	BSPP	1"1/4
2302504	I3406100-038049	1 1/2"	38,0	BSPP	1"1/2
2301772	I3406100-051060	2"	50,0	BSPP	2"
2301773	I3406100-063076	2 9/16"	65,0	BSPP	2"1/2
2301770	I3406100-076090	3"	75,0	BSPP	3"
2302505	I3406100-102114	4"	100,0	BSPP	4"

To assemble the insert, use "Safety clamps EN 14 420-3 / DIN 2817" and "Safety clamps Flexoline®": consult chapter "Clamps"

// EN 14 420-5 / DIN 2817**BSPP Male - EN 14 420-2 / DIN 2817 hose shank - Brass**

Item Code	Product Code	Hose ID	Hose ID	Thread type	Thread
		in	mm		in
2302761	I8406100-013021	1/2"	13,0	BSPP	1/2"
2302762	I8406100-019027	3/4"	19,0	BSPP	3/4"
2301774	I8406100-025034	1"	25,0	BSPP	1"
2302763	I8406100-032042	1 1/4"	32,0	BSPP	1"1/4
2301775	I8406100-038049	1 1/2"	38,0	BSPP	1"1/2
2301776	I8406100-051060	2"	50,0	BSPP	2"
2301777	I8406100-063076	2 9/16"	65,0	BSPP	2"1/2
2301778	I8406100-076090	3"	75,0	BSPP	3"
2301779	I8406100-102114	4"	100,0	BSPP	4"

To assemble the insert, use "Safety clamps EN 14 420-3 / DIN 2817" and "Safety clamps Flexoline®": consult chapter "Clamps"

// EN 14 420-5 / DIN 2817**BSPP Female with swivel nut - EN 14 420-2 / DIN 2817 hose shank - Stainless steel 316**

Item Code	Product Code	Hose ID	Hose ID	Thread type	Thread
		in	mm		in
2302506	I3406200-013021	1/2"	13,0	BSPP	1/2"
2302507	I3406200-019027	3/4"	19,0	BSPP	3/4"
2302508	I3406200-025034	1"	25,0	BSPP	1"
2301734	I3406200-032042	1 1/4"	32,0	BSPP	1"1/4
2302509	I3406200-038049	1 1/2"	38,0	BSPP	1"1/2
2302510	I3406200-051060	2"	50,0	BSPP	2"
2302511	I3406200-063076	2 9/16"	65,0	BSPP	2"1/2
2302512	I3406200-076090	3"	75,0	BSPP	3"
2302513	I3406200-102114	4"	100,0	BSPP	4"

To assemble the insert, use "Safety clamps EN 14 420-3 / DIN 2817" and "Safety clamps Flexoline®": consult chapter "Clamps"

// EN 14 420-5 / DIN 2817**BSPP Female with swivel nut - EN 14 420-2 / DIN 2817 hose shank - Brass**

Item Code	Product Code	Hose ID	Hose ID	Thread type	Thread
		in	mm		in
2302771	I8406200-013021	1/2"	13,0	BSPP	1/2"
2302772	I8406200-019027	3/4"	19,0	BSPP	3/4"
2301598	I8406200-025034	1"	25,0	BSPP	1"
2301599	I8406200-032042	1 1/4"	32,0	BSPP	1"1/4
2301600	I8406200-038049	1 1/2"	38,0	BSPP	1"1/2
2301780	I8406200-051060	2"	50,0	BSPP	2"
2301781	I8406200-063076	2 9/16"	65,0	BSPP	2"1/2
2301782	I8406200-076090	3"	75,0	BSPP	3"
2301783	I8406200-102114	4"	100,0	BSPP	4"

To assemble the insert, use "Safety clamps EN 14 420-3 / DIN 2817" and "Safety clamps Flexoline®": consult chapter "Clamps"



// AVIATION

// EN 14 420-5 / DIN 2817 - HOSE SHANK.....	256
// BSPP MALE THREADED FITTING.....	257
// SAFETY CLAMP EN 14 420-3 / DIN 2817	257
// SERRATED FERRULE.....	258

// EN 14 420-5 / DIN 2817 - HOSE SHANK**// EN 14 420-5 / DIN 2817****BSPP Male - EN 14 420-2 / DIN 2817 hose shank - Tinned Brass**

Item Code	Product Code	Hose ID	Hose ID	Thread type	Thread
		in	mm		in
2302764	I840610A-025034	1"	25,0	BSPP	1"
2302765	I840610A-032042	1 1/4"	32,0	BSPP	1"1/4
2302766	I840610A-038049	1 1/2"	38,0	BSPP	1"1/2
2302767	I840610A-051060	2"	51,0	BSPP	2"
2302768	I840610A-063076	2 1/2"	63,0	BSPP	2"1/2
2302769	I840610A-076090	3"	76,0	BSPP	3"
2302770	I840610A-102114	4"	102,0	BSPP	4"

// EN 14 420-5 / DIN 2817**BSPP Female with swivel nut - EN 14 420-2 / DIN 2817 hose shank - Tinned Brass**

Item Code	Product Code	Hose ID	Hose ID	Thread type	Thread
		in	mm		in
2302100	I840620A-025034	1"	25,0	BSPP	1"
2302773	I840620A-032042	1 1/4"	32,0	BSPP	1"1/4
2302774	I840620A-038049	1 1/2"	38,0	BSPP	1"1/2
2302775	I840620A-051060	2"	51,0	BSPP	2"
2302776	I840620A-063076	2 1/2"	63,0	BSPP	2"1/2
2302777	I840620A-076090	3"	76,0	BSPP	3"
2302778	I840620A-102114	4"	102,0	BSPP	4"

Dimensions shown may be changed without prior notice

// BSPP MALE THREADED FITTING

// BSPP MALE THREADED FITTING

BSPP Male - Serrated hose shank with collar suitable also for safety clamps EN 24 420-3 / DIN 2817 - Aluminium



Item Code	Product Code	Hose ID	Hose ID	Thread type	Thread
		in	mm		in
2302690	I5906100-025034	1"	25,0	BSPP	1"
2302079	I5906100-032042	1 1/4"	32,0	BSPP	1"1/4
2302080	I5906100-038049	1 1/2"	38,0	BSPP	1"1/2
2302081	I5906100-051060	2"	51,0	BSPP	2"
2302082	I5906100-063076	2 1/2"	63,0	BSPP	2"1/2
2302691	I5906100-076090	3"	76,0	BSPP	3"
2302692	I5906100-102114	4"	102,0	BSPP	4"

// SAFETY CLAMP EN 14 420-3 / DIN 2817

// SAFETY CLAMPS EN 14 420-3 / DIN 2817

Safety clamps - Aluminium



Item Code	Product Code	Hose ID	Hose ID	Hose OD (min)	Hose OD (max)
		in	mm	mm	mm
2301784	I5LG4D-025041	1"	25,0	40,0	43,0
2307549	I5LG4D-032045	1 1/4"	32,0	43,0	46,0
2301785	I5LG4D-032048	1 1/4"	32,0	47,0	50,0
2306262	I5LG4D-038052	1 1/2"	38,0	50,0	52,0
2301786	I5LG4D-038054	1 1/2"	38,0	53,0	56,0
2304563	I5LG4D-050066	2"	51,0	64,0	67,0
2301787	I5LG4D-051070	2"	51,0	69,0	71,0
2301788	I5LG4D-063081	2 1/2"	63,0	78,0	81,0
2304564	I5LG4D-075091	3"	76,0	89,0	93,0
2301789	I5LG4D-076096	3"	76,0	94,0	97,0
2307550	I5LG4D-100117	4"	102,0	114,0	119,0
2303001	I5LG4D-102120	4"	102,0	118,0	122,0
2301790	I5LG4D-102124	4"	102,0	122,0	126,0

// SERRATED FERRULE

// I109U

Serrated ferrule - for aviation - Plated Steel



Item Code	Product Code	Hose ID	Hose ID	Hose OD (min)	Hose OD (max)
		in	mm	mm	mm
2302264	I109U025-037042	1"	25,0	37,0	42,0
2302265	I109U032-044048	1 1/4"	32,0	44,0	48,0
2302112	I109U038-050054	1 1/2"	38,0	50,0	54,0
2302266	I109U051-065071	2"	51,0	65,0	71,0
2302113	I109U063-077083	2 1/2"	63,0	77,0	83,0
2302114	I109U076-090096	3"	76,0	90,0	96,0
2302267	I109U102-116124	4"	102,0	116,0	124,0



// SANDBLAST

// SANDBLAST - QUICK COUPLING	260
// SANDBLAST - NOZZLE HOLDER	261
// SANDBLAST - ADAPTER	262

// SANDBLAST - QUICK COUPLING

// SANDBLAST

Quick coupling complete with seal - Malleable iron



Item Code	Product Code	Hose ID	Hose ID	Claw Distance Internal	Claw Distance External	Hose OD (min)	Hose OD (max)
		in	mm	mm	mm	mm	mm
2307121	I9C9I300-019027	3/4"	19,0	58	-	31,0	31,0
2305689	I9C9I300-025034	1"	25,0	58	-	39,0	39,0
2305690	I9C9I300-032042	1 1/4"	32,0	58	-	48,0	48,0
2307122	I9C9I300-038049	1 1/2"	38,0	58	-	56,0	56,0

// SANDBLAST

Quick coupling complete with seal - PA-Nylon



Item Code	Product Code	Hose ID	Hose ID	Claw Distance Internal	Claw Distance External	Hose OD (min)	Hose OD (max)
		in	mm	mm	mm	mm	mm
2304636	IRC9I300-019027	3/4"	19,0	58	-	33,0	33,0
2305641	IRC9I300-025034	1"	25,0	58	-	39,0	39,0
2304637	IRC9I300-032042	1 1/4"	32,0	58	-	48,0	48,0
2305642	IRC9I300-038049	1 1/2"	38,0	58	-	56,0	56,0

Dimensions shown may be changed without prior notice

// SANDBLAST - NOZZLE HOLDER**// SANDBLAST****Nozzle holder - BSPP Female - Aluminium**

Item Code	Product Code	Hose ID	Hose ID	Thread type	Thread	Hose OD (min)	Hose OD (max)
		in	mm		in	mm	mm
2307124	I5C9106D-032042	1 1/4"	32,0	BSPP	1"1/4	48,0	48,0

// SANDBLAST**Nozzle holder - BSPP Female - PA-Nylon**

Item Code	Product Code	Hose ID	Hose ID	Thread type	Thread	Hose OD (min)	Hose OD (max)
		in	mm		in	mm	mm
2307126	IRC9106D-019042	3/4"	19,0	BSPP	1"1/4	33,0	33,0
2307127	IRC9106D-025042	1"	25,0	BSPP	1"1/4	39,0	39,0
2307128	IRC9106D-032042	1 1/4"	32,0	BSPP	1"1/4	48,0	48,0
2307129	IRC9106D-038042	1 1/2"	38,0	BSPP	1"1/4	56,0	56,0

// SANDBLAST**Nozzle holder - Female coarse thread - Aluminium**

Item Code	Product Code	Hose ID	Hose ID	Thread type	Thread	Hose OD (min)	Hose OD (max)
		in	mm		in	mm	mm
2303915	I5C50200-032060	1 1/4"	32,0	MET	COARSE THREAD 50 mm	-	-

// SANDBLAST**Nozzle holder - Female coarse thread - PA-Nylon**

Item Code	Product Code	Hose ID	Hose ID	Thread type	Thread	Hose OD (min)	Hose OD (max)
		in	mm		in	mm	mm
2303917	IRC50200-019060	3/4"	19,0	MET	COARSE THREAD 50 mm	-	-
2303918	IRC50200-025060	1"	25,0	MET	COARSE THREAD 50 mm	-	-
2303919	IRC50200-032060	1 1/4"	32,0	MET	COARSE THREAD 50 mm	-	-
2303920	IRC50200-038060	1 1/2"	38,0	MET	COARSE THREAD 50 mm	-	-

// SANDBLAST - ADAPTER

// SANDBLAST

Sandblast complete with seal - BSPP Female - Malleable iron



Item Code	Product Code	Head DN side 1	Head DN side 1	Claw Distance Internal side 1	Claw Distance External side 1	Technical Note side 1	Thread type 2	Thread 2
		in	mm	mm	mm			in
2304638	I9A9I306-000049	-	58,0	58	-	-	BSPP	1"1/2

// SANDBLAST

Sandblast complete with seal - BSPP Female - PA-Nylon



Item Code	Product Code	Head DN side 1	Head DN side 1	Claw Distance Internal side 1	Claw Distance External side 1	Technical Note side 1	Thread type 2	Thread 2
		in	mm	mm	mm			in
2307123	I9A9I306-000042	-	58,0	58	-	-	BSPP	1"1/4



// MORTAR

// MORTAR - HOSE SHANK.....	264
// MORTAR - FERRULE & CRIMPING RING.....	266

// MORTAR - HOSE SHANK**// MORTAR****System 22 - Male adapter - Hose shank - Malleable iron**

Item Code	Product Code	Hose ID	Hose ID	Head DN
		in	mm	mm
2302084	I938C100-025025	1"	25,0	35,0
2301758	I938C100-025X25	1"	25,0	41,0
2302085	I938C100-025035	1"	25,0	49,5
2302086	I938C100-035035	1 3/8"	35,0	49,5
2302087	I938C100-035050	1 3/8"	35,0	63,0
2302088	I938C100-050050	2"	51,0	63,0

// MORTAR**System 23.5 - Male adapter - Hose shank - Malleable iron**

Item Code	Product Code	Hose ID	Hose ID	Head DN
		in	mm	mm
2302089	I938C101-025035	1"	25,0	49,5
2302090	I938C101-035035	1 3/8"	35,0	49,5
2301757	I938C101-035050	1 3/8"	35,0	63,0
2302091	I938C101-050050	2"	51,0	63,0

Dimensions shown may be changed without prior notice

// MORTAR

System 22 - Female coupler complete with seal - Hose shank - Malleable iron



Item Code	Product Code	Hose ID		Head DN mm
		in	mm	
2302092	I938C200-025025	1"	25,0	35,5
2302093	I938C200-025X25	1"	25,0	42,0
2302818	I938C200-025035	1"	25,0	51,0
2302094	I938C200-035035	1 3/8"	35,0	51,0
2302819	I938C200-035050	1 3/8"	35,0	64,0
2302095	I938C200-050050	2"	51,0	64,0

// MORTAR

System 23.5 - Female coupler complete with seal - Hose shank - Malleable iron



Item Code	Product Code	Hose ID		Head DN mm
		in	mm	
2302096	I938C201-025035	1"	25,0	51,0
2302097	I938C201-035035	1 3/8"	35,0	51,0
2302820	I938C201-035050	1 3/8"	35,0	64,0
2302098	I938C201-050050	2"	51,0	64,0

// MORTAR

BSPP Male - Hose shank - Plated steel



Item Code	Product Code	Hose ID		Thread type	Thread
		in	mm		in
2302310	I1306100-025034	1"	25,0	BSPP	1"
2302311	I1306100-035042	1 3/8"	35,0	BSPP	1"1/4
2302083	I1306100-050060	2"	51,0	BSPP	2"

// MORTAR - FERRULE & CRIMPING RING**// R5YBFF0-M****Crimping ring - Aluminium**

Item Code	Product Code	Ferrule ID	Ferrule OD	L
		mm	mm	mm
2303031	R5YBFF0-0452550	45,00	50,0	50,0
2303032	R5YBFF0-0552555	55,00	60,0	55,0
1900418	R5YBFF0-0752555	75,00	80,0	55,0



// CONCRETE

// CONCRETE COUPLING - VICTAULIC COMPATIBLE STYLE	268
// CONCRETE COUPLING - SHOULDERED STYLE	268
// CONCRETE COUPLING - CALIFORNIA STYLE.....	269
// CONCRETE COUPLING - SCHWING STYLE.....	269
// CONCRETE COUPLING - THREADED STYLE	270

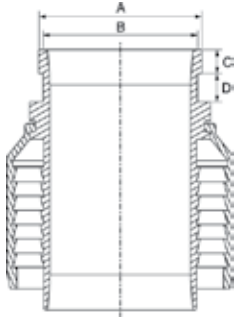
// CONCRETE COUPLING - VICTAULIC COMPATIBLE STYLE**// VICTAULIC COMPATIBLE STYLE****Hardened steel hose shank complete with pre-crimped ferrule**

Item Code	Product Code	Hose ID	Hose ID	Head DN	Head DN	A	B	C	D	Hose OD (min)	Hose OD (max)
		in	mm	in	mm	mm	mm	mm	mm	mm	mm
2306772	IV39VL00-051060	2"	51,0	2"	60,3	60,3	57,2	16,0	20,0	66,0	69,0
2301752	IV39VL00-051089	2"	51,0	3"	88,9	88,9	84,9	16,0	20,0	66,0	69,0
2301753	IV39VL00-063089	2 1/2"	63,0	3"	88,9	88,9	84,9	16,0	20,0	82,0	86,0
2301754	IV39VL00-076089	3"	76,0	3"	88,9	88,9	84,9	16,0	20,0	97,0	103,0
2302892	IV39VL00-076097	3"	76,0	3 1/4"	97,0	97,0	88,5	16,0	20,0	97,0	103,0
2302217	IV39VL00-102114	4"	102,0	4"	114,3	114,3	108,3	17,0	20,0	125,0	130,0
2302216	IV39VL00-102127	4"	102,0	4 1/2"	127,0	127,0	115,0	17,0	20,0	125,0	130,0
2302219	IV39VL00-127142	5"	127,0	5"	142,0	142,0	133,0	17,0	20,0	154,0	157,0
2302220	IV39VL00-127148	5"	127,0	5 1/2"	148,0	148,0	139,0	17,0	20,0	154,0	157,0
2302893	IV39VL00-152168	6"	152,0	6"	168,3	168,3	159,0	17,0	20,0	183,0	190,0

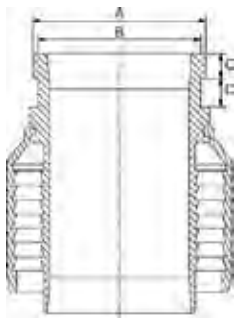
// CONCRETE COUPLING - SHOULDERED STYLE**// SHOULDERED STYLE****Hardened steel hose shank complete with pre-crimped ferrule**

Item Code	Product Code	Hose ID	Hose ID	Head DN	Head DN	A	B	C	D	Hose OD (min)	Hose OD (max)
		in	mm	in	mm	mm	mm	mm	mm	mm	mm
2303021	IV39RL00-051067	2"	51,0	2"	66,5	66,5	59,5	16,0	20,0	66,0	69,0
2303022	IV39RL00-063097	2 1/2"	63,0	3"	97,0	97,0	88,5	16,0	20,0	82,0	86,0
2303023	IV39RL00-076097	3"	76,0	3"	97,0	97,0	88,5	16,0	20,0	97,0	103,0
2303024	IV39RL00-090122	3 1/2"	90,0	4"	122,0	122,0	115,0	17,5	20,0	113,0	116,0
2306505	IV39RL00-090127	3 1/2"	90,0	4 1/2"	127,0	127,0	115,0	17,0	20,0	113,0	116,0
2303025	IV39RL00-102122	4"	102,0	4"	122,0	122,0	115,0	17,5	20,0	125,0	130,0

Dimensions shown may be changed without prior notice

// CONCRETE COUPLING - CALIFORNIA STYLE

// CALIFORNIA STYLE - HEAVY DUTY RAISED END

Hardened steel hose shank complete with pre-crimped ferrule

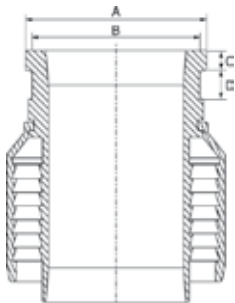

Item Code	Product Code	Hose ID	Hose ID	Head DN	Head DN	A	B	C	D	Hose OD (min)	Hose OD (max)
		in	mm	in	mm	mm	mm	mm	mm	mm	mm
2303026	IV39JL00-051078	2"	51,0	2"	77,7	77,7	69,9	12,7	20,0	66,0	69,0
2303027	IV39JL00-063082	2 1/2"	63,0	2 1/2"	82,3	82,3	73,2	12,3	20,0	82,0	86,0
2303028	IV39JL00-076106	3"	76,0	3"	106,2	106,2	97,0	12,7	20,0	97,0	103,0
2303029	IV39JL00-102132	4"	102,0	4"	131,6	131,6	122,0	15,2	20,0	125,0	130,0
2303030	IV39JL00-127157	5"	127,0	5"	157,0	157,0	147,3	15,2	20,0	154,0	157,0

// CONCRETE COUPLING - SCHWING STYLE

// SCHWING STYLE

Female - Hardened steel hose shank complete with pre-crimped ferrule

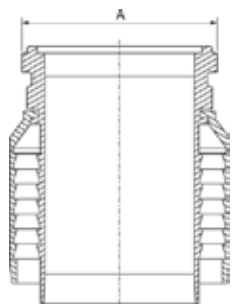

Item Code	Product Code	Hose ID	Hose ID	Head DN	Head DN	A	B	C	D	Hose OD (min)	Hose OD (max)
		in	mm	in	mm	mm	mm	mm	mm	mm	mm
2302894	IV39WF00-102102	4"	102,0	4"	148,0	148,0	-	-	-	125,0	130,0
2302895	IV39WF00-127127	5"	127,0	5"	166,0	166,0	-	-	-	154,0	157,0
2306524	IV39WF00-152152	6"	152,0	6"	195,0	195,0	-	-	-	183,0	190,0

// SCHWING STYLE

Male - Hardened steel hose shank complete with pre-crimped ferrule

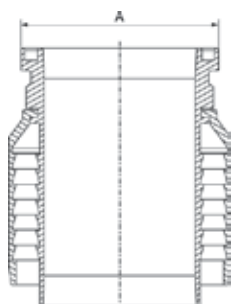

Item Code	Product Code	Hose ID	Hose ID	Head DN	Head DN	A	B	C	D	Hose OD (min)	Hose OD (max)
		in	mm	in	mm	mm	mm	mm	mm	mm	mm
2302896	IV39WM00-102102	4"	102,0	4"	148,0	148,0	-	-	-	125,0	130,0
2302897	IV39WM00-127127	5"	127,0	5"	166,0	166,0	-	-	-	154,0	157,0
2306525	IV39WM00-152152	6"	152,0	6"	195,0	195,0	-	-	-	183,0	190,0

// CONCRETE COUPLING - THREADED STYLE

// THREADED STYLE

BSPT Male - Hardened steel hose shank complete with pre-crimped ferrule

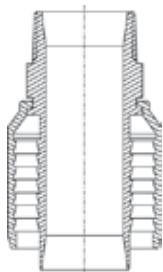

Item Code	Product Code	Hose ID	Hose ID	Thread type	Thread	Hose OD (min)	Hose OD (max)
		in	mm		in	mm	mm
2301755	IV307M00-051060	2"	51,0	BSPT	2"	66,0	69,0
2301756	IV307M00-076090	3"	76,0	BSPT	3"	97,0	103,0

// THREADED STYLE

NPT Male - Hardened steel hose shank complete with pre-crimped ferrule

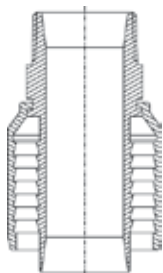

Item Code	Product Code	Hose ID	Hose ID	Thread type	Thread	Hose OD (min)	Hose OD (max)
		in	mm		in	mm	mm
2302890	IV328M00-051060	2"	51,0	NPT	2"	66,0	69,0
2302891	IV328M00-076090	3"	76,0	NPT	3"	97,0	103,0

// THREADED STYLE

BSPP Female - Hardened steel hose shank complete with pre-crimped ferrule

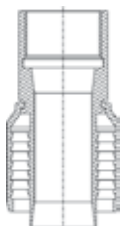

Item Code	Product Code	Hose ID	Hose ID	Thread type	Thread	Hose OD (min)	Hose OD (max)
		in	mm		in	mm	mm
2306526	IV306F00-051060	2"	51,0	BSPP	2"	66,0	69,0

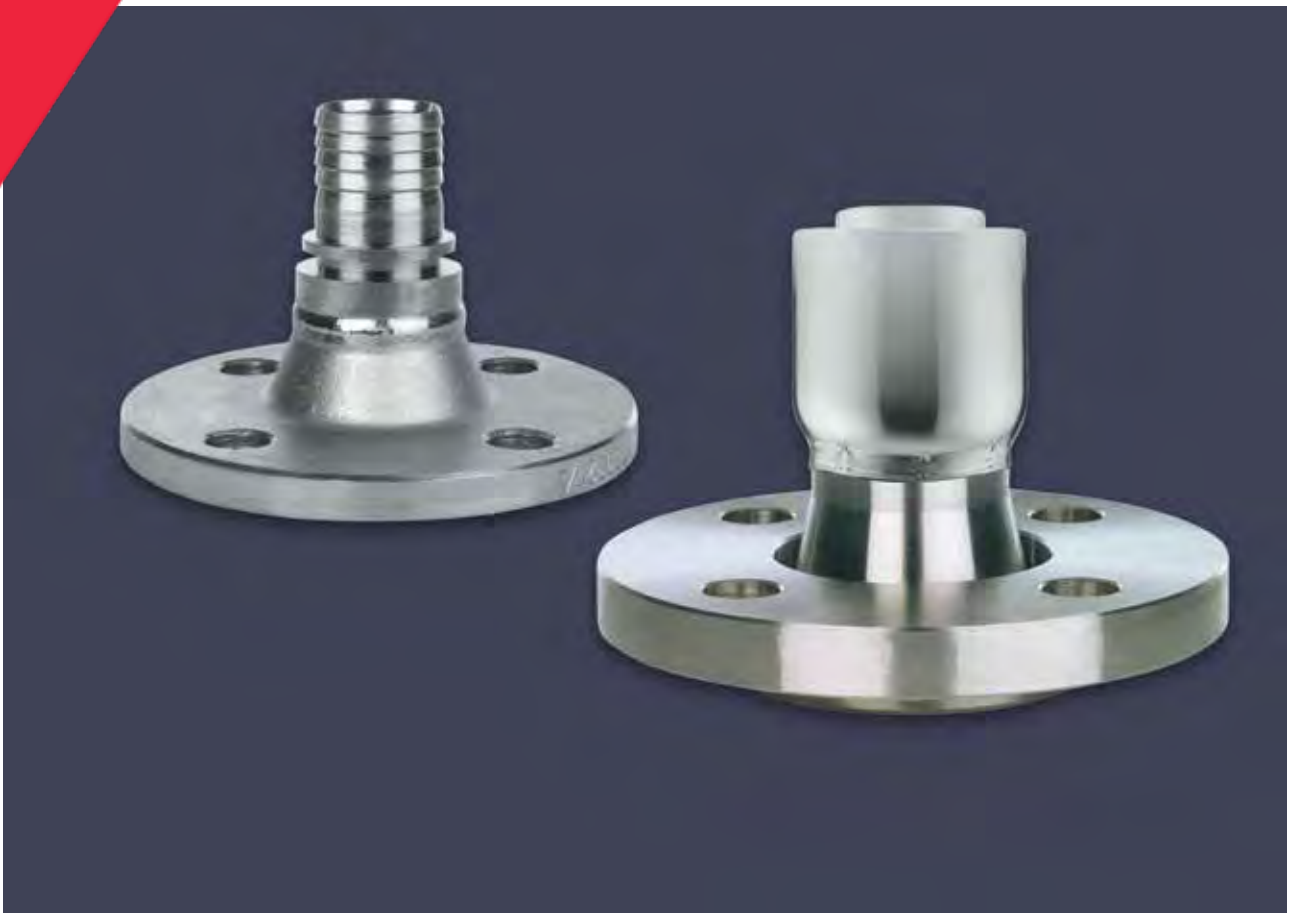

// FLANGED FITTING

// FIXED FLANGE - EN 1092-1 PN10/16	272
// FIXED FLANGE - ASME ANSI B 16.5 - ASA 150	274
// SWIVEL FLANGE - EN 1092-1 PN10/16	276
// SWIVEL FLANGE - ASME ANSI B 16.5 - ASA 150	279
// FLANGE - FERRULE	281
// FIXED FLANGE - SPLIT COUPLING - AS 2129 TABLE D.....	281

// FIXED FLANGE - EN 1092-1 PN10/16**// FIXED FLANGE - PLATE RF - PN 10/16****Serrated hose shank with pre-crimped ferrule - Plated steel**

Item Code	Product Code	Hose ID	Hose ID	Thread type	Head DN	Head DN	Hose OD (min)	Hose OD (max)
		in	mm		in	mm	mm	mm
2307313	I17BDW1B-00S076	3"	76,0	PN16	3"	76,0	86,0	96,0
2307314	I17BDW1B-076076	3"	76,0	PN16	3"	76,0	88,0	102,0
2307315	I17BDW1B-00S102	4"	102,0	PN16	4"	102,0	112,0	122,0
2307316	I17BDW1B-102102	4"	102,0	PN16	4"	102,0	114,0	128,0
2307317	I17BDW1B-00S127	5"	127,0	PN16	5"	127,0	139,0	147,0
2307318	I17BDW1B-127127	5"	127,0	PN16	5"	127,0	139,0	153,0
2307319	I17BDW1B-00S152	6"	152,0	PN16	6"	152,0	166,0	172,0
2307320	I17BDW1B-152152	6"	152,0	PN16	6"	152,0	166,0	184,0

// FIXED FLANGE - PLATE RF - PN 10/16**Serrated hose shank with pre-crimped ferrule - Stainless steel 316**

Item Code	Product Code	Hose ID	Hose ID	Thread type	Head DN	Head DN	Hose OD (min)	Hose OD (max)
		in	mm		in	mm	mm	mm
2307346	I37BDW1B-076076	3"	76,0	PN16	3"	76,0	88,0	102,0
2307348	I37BDW1B-102102	4"	102,0	PN16	4"	102,0	114,0	128,0
2307350	I37BDW1B-127127	5"	127,0	PN16	5"	127,0	139,0	153,0
2307352	I37BDW1B-152152	6"	152,0	PN16	6"	152,0	166,0	184,0

Dimensions shown may be changed without prior notice

// FIXED FLANGE - PLATE RF - PN 10/16**Serrated hose shank with collar - Plated steel**

Item Code	Product Code	Hose ID	Hose ID	Thread type	Head DN	Head DN
		in	mm		in	mm
2307233	I17BD61B-A00051	2"	51,0	PN16	2"	51,0
2307242	I17BD61B-A00203	8"	203,0	PN16	8"	203,0
2307243	I17BD61B-A00254	10"	254,0	PN16	10"	254,0

// FIXED FLANGE - PLATE RF - PN 10/16**Serrated hose shank with collar - Stainless steel 316**

Item Code	Product Code	Hose ID	Hose ID	Thread type	Head DN	Head DN
		in	mm		in	mm
2307277	I37BD61B-A00051	2"	51,0	PN16	2"	51,0
2307286	I37BD61B-A00203	8"	203,0	PN16	8"	203,0
2307287	I37BD61B-A00254	10"	254,0	PN16	10"	254,0

// FIXED FLANGE - ASME ANSI B 16.5 - ASA 150**// FIXED FLANGE - SLIP ON RF - ASA 150****Serrated hose shank with pre-crimped ferrule - Plated steel**

Item Code	Product Code	Hose ID	Hose ID	Thread type	Head DN	Head DN	Hose OD (min)	Hose OD (max)
		in	mm		in	mm	mm	mm
2307299	I17BEW7B-00S076	3"	76,0	ASA150	3"	76,0	86,0	96,0
2307300	I17BEW7B-076076	3"	76,0	ASA150	3"	76,0	88,0	102,0
2307301	I17BEW7B-00S102	4"	102,0	ASA150	4"	102,0	112,0	122,0
2302366	I17BEW7B-102102	4"	102,0	ASA150	4"	102,0	114,0	128,0
2307302	I17BEW7B-00S127	5"	127,0	ASA150	5"	127,0	139,0	147,0
2307303	I17BEW7B-127127	5"	127,0	ASA150	5"	127,0	139,0	153,0
2307304	I17BEW7B-00S152	6"	152,0	ASA150	6"	152,0	166,0	172,0
2302368	I17BEW7B-152152	6"	152,0	ASA150	6"	152,0	166,0	184,0

// FIXED FLANGE - SLIP ON RF - ASA 150**Serrated hose shank with pre-crimped ferrule - Stainless steel 316**

Item Code	Product Code	Hose ID	Hose ID	Thread type	Head DN	Head DN	Hose OD (min)	Hose OD (max)
		in	mm		in	mm	mm	mm
2307330	I37BEW7B-076076	3"	76,0	ASA150	3"	76,0	88,0	102,0
2307332	I37BEW7B-102102	4"	102,0	ASA150	4"	102,0	114,0	128,0
2307334	I37BEW7B-127127	5"	127,0	ASA150	5"	127,0	139,0	153,0
2307336	I37BEW7B-152152	6"	152,0	ASA150	6"	152,0	166,0	184,0

Dimensions shown may be changed without prior notice

// FIXED FLANGE - SLIP ON RF - ASA 150**Serrated hose shank with collar - Plated steel**

Item Code	Product Code	Hose ID	Hose ID	Thread type	Head DN	Head DN
		in	mm		in	mm
2307211	I17BE67B-A00051	2"	51,0	ASA150	2"	51,0
2307220	I17BE67B-A00203	8"	203,0	ASA150	8"	203,0
2307221	I17BE67B-A00254	10"	254,0	ASA150	10"	254,0

// FIXED FLANGE - SLIP ON RF - ASA 150**Serrated hose shank with collar - Stainless steel 316**

Item Code	Product Code	Hose ID	Hose ID	Thread type	Head DN	Head DN
		in	mm		in	mm
2307255	I37BE67B-A00051	2"	51,0	ASA150	2"	51,0
2307264	I37BE67B-A00203	8"	203,0	ASA150	8"	203,0
2307265	I37BE67B-A00254	10"	254,0	ASA150	10"	254,0

// SWIVEL FLANGE - EN 1092-1 PN10/16**// SWIVEL FLANGE - PLATE FF - PN 10/16****Serrated hose shank with pre-crimped ferrule - Plated steel**

Item Code	Product Code	Hose ID	Hose ID	Thread type	Head DN	Head DN	Hose OD (min)	Hose OD (max)
		in	mm		in	mm	mm	mm
2307321	I17BDT2A-00S076	3"	76,0	PN16	3"	76,0	86,0	96,0
2307322	I17BDT2A-076076	3"	76,0	PN16	3"	76,0	88,0	102,0
2307323	I17BDT2A-00S102	4"	102,0	PN16	4"	102,0	112,0	122,0
2307324	I17BDT2A-102102	4"	102,0	PN16	4"	102,0	114,0	128,0
2307325	I17BDT2A-00S127	5"	127,0	PN16	5"	127,0	139,0	147,0
2307326	I17BDT2A-127127	5"	127,0	PN16	5"	127,0	139,0	153,0
2307327	I17BDT2A-00S152	6"	152,0	PN16	6"	152,0	166,0	172,0
2307328	I17BDT2A-152152	6"	152,0	PN16	6"	152,0	166,0	184,0

// SWIVEL FLANGE - PLATE FF - PN 10/16**Serrated hose shank with pre-crimped ferrule - Stainless steel 316**

Item Code	Product Code	Hose ID	Hose ID	Thread type	Head DN	Head DN	Hose OD (min)	Hose OD (max)
		in	mm		in	mm	mm	mm
2307354	I37BDT2A-076076	3"	76,0	PN16	3"	76,0	88,0	102,0
2307356	I37BDT2A-102102	4"	102,0	PN16	4"	102,0	114,0	128,0
2307358	I37BDT2A-127127	5"	127,0	PN16	5"	127,0	139,0	153,0
2307360	I37BDT2A-152152	6"	152,0	PN16	6"	152,0	166,0	184,0

Dimensions shown may be changed without prior notice

// SWIVEL FLANGE - PLATE FF - PN 10/16**Serrated hose shank with collar - Plated steel**

Item Code	Product Code	Hose ID	Hose ID	Thread type	Head DN	Head DN
		in	mm		in	mm
2307244	I17BD72A-A00051	2"	51,0	PN16	2"	51,0
2307253	I17BD72A-A00203	8"	203,0	PN16	8"	203,0
2307254	I17BD72A-A00254	10"	254,0	PN16	10"	254,0

// SWIVEL FLANGE - PLATE FF - PN 10/16**Serrated hose shank with collar - Stainless steel 316**

Item Code	Product Code	Hose ID	Hose ID	Thread type	Head DN	Head DN
		in	mm		in	mm
2307288	I37BD72A-A00051	2"	51,0	PN16	2"	51,0
2307297	I37BD72A-A00203	8"	203,0	PN16	8"	203,0
2307298	I37BD72A-A00254	10"	254,0	PN16	10"	254,0

// SWIVEL FLANGE - PLATE FF - PN 10/16**EN 14 420-2 / DIN 2817 hose shank - Plated steel**

Item Code	Product Code	Hose ID	Hose ID	Thread type	Head DN	Head DN
		in	mm		in	mm
2306420	I14BD74A-032032	1 1/4"	32,0	PN16	1 1/4"	32,0
2302312	I14BD74A-038038	1 1/2"	38,0	PN16	1 1/2"	40,0
2302313	I14BD74A-051051	2"	50,0	PN16	2"	50,0
2302314	I14BD74A-063063	2 1/2"	63,0	PN16	2 1/2"	65,0
2302315	I14BD74A-076076	3"	75,0	PN16	3 1/8"	80,0
2302317	I14BD74A-102102	4"	100,0	PN16	4"	100,0
2302318	I14BD74A-127127	5"	125,0	PN16	5"	125,0
2302319	I14BD74A-152152	6"	150,0	PN16	6"	150,0
2302009	I14BD74A-203203	8"	200,0	PN16	8"	200,0

To assemble the insert, use "Safety clamps EN 14 420-3 / DIN 2817" and "Safety clamps Flexoline®": consult chapter "Clamps"

// SWIVEL FLANGE - PLATE FF - PN 10/16**EN 14 420-2 / DIN 2817 hose shank - Stainless steel 316**

Item Code	Product Code	Hose ID	Hose ID	Thread type	Head DN	Head DN
		in	mm		in	mm
2304871	I34BD74A-025025	1"	25,0	PN16	1"	25,0
2304870	I34BD74A-038038	1 1/2"	38,0	PN16	1 1/2"	40,0
2302543	I34BD74A-051051	2"	50,0	PN16	2"	50,0
2304872	I34BD74A-063063	2 1/2"	63,0	PN16	2 1/2"	65,0
2302544	I34BD74A-076076	3"	76,0	PN16	3"	75,0
2302010	I34BD74A-102102	4"	102,0	PN16	4"	100,0
2304873	I34BD74A-152152	6"	150,0	PN16	6"	150,0

To assemble the insert, use "Safety clamps EN 14 420-3 / DIN 2817" and "Safety clamps Flexoline®": consult chapter "Clamps"

Dimensions shown may be changed without prior notice

// SWIVEL FLANGE - ASME ANSI B 16.5 - ASA 150**// SWIVEL FLANGE - LAP JOINT FF - ASA 150****Serrated hose shank with pre-crimped ferrule - Plated steel**

Item Code	Product Code	Hose ID		Thread type	Head DN		Hose OD	
		in	mm		in	mm	(min) mm	(max) mm
2307305	I17BET9A-00S076	3"	76,0	ASA150	3"	76,0	86,0	96,0
2307306	I17BET9A-076076	3"	76,0	ASA150	3"	76,0	88,0	102,0
2307307	I17BET9A-00S102	4"	102,0	ASA150	4"	102,0	112,0	122,0
2307308	I17BET9A-102102	4"	102,0	ASA150	4"	102,0	114,0	128,0
2307309	I17BET9A-00S127	5"	127,0	ASA150	5"	127,0	139,0	147,0
2307310	I17BET9A-127127	5"	127,0	ASA150	5"	127,0	139,0	153,0
2307311	I17BET9A-00S152	6"	152,0	ASA150	6"	152,0	166,0	172,0
2307312	I17BET9A-152152	6"	152,0	ASA150	6"	152,0	166,0	184,0

// SWIVEL FLANGE - LAP JOINT FF - ASA 150**Serrated hose shank with pre-crimped ferrule - Stainless steel 316**

Item Code	Product Code	Hose ID		Thread type	Head DN		Hose OD	
		in	mm		in	mm	(min) mm	(max) mm
2307338	I37BET9A-076076	3"	76,0	ASA150	3"	76,0	88,0	102,0
2307340	I37BET9A-102102	4"	102,0	ASA150	4"	102,0	114,0	128,0
2307342	I37BET9A-127127	5"	127,0	ASA150	5"	127,0	139,0	153,0
2307344	I37BET9A-152152	6"	152,0	ASA150	6"	152,0	166,0	184,0

// SWIVEL FLANGE - LAP JOINT FF - ASA 150**Serrated hose shank with collar - Plated steel**

Item Code	Product Code	Hose ID	Hose ID	Thread type	Head DN	Head DN
		in	mm		in	mm
2307222	I17BE79A-A00051	2"	51,0	ASA150	2"	51,0
2307231	I17BE79A-A00203	8"	203,0	ASA150	8"	203,0
2307232	I17BE79A-A00254	10"	254,0	ASA150	10"	254,0

// SWIVEL FLANGE - LAP JOINT FF - ASA 150**Serrated hose shank with collar - Stainless steel 316**

Item Code	Product Code	Hose ID	Hose ID	Thread type	Head DN	Head DN
		in	mm		in	mm
2307266	I37BE79A-A00051	2"	51,0	ASA150	2"	51,0
2307275	I37BE79A-A00203	8"	203,0	ASA150	8"	203,0
2307276	I37BE79A-A00254	10"	254,0	ASA150	10"	254,0

Dimensions shown may be changed without prior notice

// FLANGE - FERRULE

// I107U-AF

Serrated ferrule - Plated steel



Item Code	Product Code	Hose ID	Hose ID	Hose OD (min)	Hose OD (max)
		in	mm	mm	mm
2307171	I107U203-219235	8"	203,0	219,0	237,0
2307172	I107U254-274292	10"	254,0	274,0	292,0

Ferrule to be used only with ALFAGOMMA Fixed and Swivel flanged coupling.

// I307U-AF

Serrated ferrule - Stainless steel 316



Item Code	Product Code	Hose ID	Hose ID	Hose OD (min)	Hose OD (max)
		in	mm	mm	mm
2307173	I307U203-219235	8"	203,0	219,0	237,0
2307174	I307U254-274292	10"	254,0	274,0	292,0

Ferrule to be used only with ALFAGOMMA Fixed and Swivel flanged coupling.

// FIXED FLANGE - SPLIT COUPLING - AS 2129 TABLE D

// FIXED FLANGE - SPLIT COUPLING - AS 2129 TABLE D

Split coupling - Serration for 706AA smooth cover hose - Aluminium



Item Code	Product Code	Hose ID	Hose ID	Thread type	Head DN	Head DN
		in	mm		in	mm
2303194	I5MBZ61A-051069	2"	51,0	BS10-D	2"	51,0
2303187	I5MBZ61A-076102	3"	76,0	BS10-D	3"	76,0
2303188	I5MBZ61A-102128	4"	102,0	BS10-D	4"	102,0
2303189	I5MBZ61A-127159	5"	127,0	BS10-D	5"	127,0
2303190	I5MBZ61A-152184	6"	152,0	BS10-D	6"	152,0
2303191	I5MBZ61A-203235	8"	203,0	BS10-D	8"	203,0
2303192	I5MBZ61A-254286	10"	254,0	BS10-D	10"	254,0
2303193	I5MBZ61A-300344	12"	300,0	BS10-D	12"	300,0



// CLAMPS

// EAR PINCH CLAMP	283
// MINICLAMP	285
// BAND-IT SYSTEM	286
// WORM GEAR CLAMP	287
// SUPERCLAMP	288
// PW-CLAMP	290
// SAFETY CLAMP EN 14 420-3 / DIN 2817	293
// SAFETY CLAMPS FLEXOLINE®	294
// DOUBLE BOLT CLAMP WITH SADDLES	295
// RUBBER LINED PIPE CLIP	296

Dimensions shown may be changed without prior notice

// EAR PINCH CLAMP**// EAR PINCH ON CLAMP****Clamp - 1-ear with inner ring - W1 (Plated steel)**

Item Code	Product Code	Hose OD (min)	Hose OD (max)	Clamp Width
		mm	mm	mm
2306009	-	7,5	9,0	7,4
2306011	-	8,5	10,0	7,4
2306013	-	9,8	11,8	7,4
2306014	-	10,3	12,3	7,4
2306017	-	12,3	14,3	8,2
2306019	-	13,1	15,3	8,2
2304309	-	13,9	16,1	8,2
2306021	-	15,6	17,8	8,2

// EAR PINCH ON CLAMP**Clamp - 1-ear with inner ring - W4 (Stainless steel 304)**

Item Code	Product Code	Hose OD (min)	Hose OD (max)	Clamp Width
		mm	mm	mm
2304911	-	7,0	8,5	7,4
2304306	-	8,0	9,5	7,4
2306028	-	10,3	12,3	7,4
2306030	-	11,1	13,1	8,2
2304918	-	12,3	14,3	8,2
2306031	-	12,8	14,8	8,2
2304310	-	13,9	16,1	8,2
2304311	-	14,6	16,8	8,2
2305292	-	15,6	17,8	8,2
2306033	-	17,1	20,0	9,2

// EAR PINCH ON CLAMP**Clamp - 2-ears - W1 (Plated steel)**

Item Code	Product Code	Hose OD (min)	Hose OD (max)	Clamp Width
		mm	mm	mm
2304286	-	7,0	9,0	7,0
2304287	-	9,0	11,0	7,0
2304289	-	11,0	13,0	7,0
2304290	-	13,0	15,0	7,5
2304293	-	15,0	18,0	8,0
2304294	I1LP2E-02008	17,0	20,0	8,5
2304296	-	20,0	23,0	9,0
2304298	-	23,0	27,0	10,0

// EAR PINCH ON CLAMP**Clamp - 2-ears - W4 (Stainless steel 304)**

Item Code	Product Code	Hose OD (min)	Hose OD (max)	Clamp Width
		mm	mm	mm
2304924	-	7,0	9,0	7,0
2304288	-	9,0	11,0	7,0
2304908	-	11,0	13,0	7,0
2304291	-	13,0	15,0	7,5
2305998	-	15,0	18,0	8,0
2305999	-	17,0	20,0	8,5
2306001	-	20,0	23,0	9,0
2306003	-	23,0	27,0	10,0
2304922	-	27,0	31,0	10,0
2306005	-	31,0	34,0	10,0
2306006	-	34,0	37,0	10,0

Dimensions shown may be changed without prior notice

// MINICLAMP**// MINICLAMP****Miniclamp - 1 bolt - W1 (Plated steel)**

Item Code	Product Code	Hose OD (min)	Hose OD (max)	Clamp Width
		mm	mm	mm
2304140	-	8,0	8,0	9,0
2304142	-	9,0	9,0	10,0
2304143	-	9,5	10,0	10,0
2304144	-	10,0	11,0	10,0
2304147	-	12,0	13,0	10,0
2304148	-	13,0	14,0	10,0
2304150	-	14,0	15,0	10,0
2304154	-	15,0	17,0	10,0

// BAND-IT SYSTEM

// BAND-IT SYSTEM

Banding tool - Plated steel



Item Code	Product Code
2300912	I0LLT0

// BAND-IT SYSTEM

Banding bands - Stainless steel 304



Item Code	Product Code	Clamp Width	Band Length
		mm	m
2302154	I2LLF0-013	12,7	30,000
2302155	I2LLF0-019	19,0	30,000

286

INDUSTRIAL FITTINGS

// BAND-IT SYSTEM

Banding buckles - Stainless steel 304



Item Code	Product Code	Clamp Width	Band Length
		mm	m
2302157	I2LLB0-013	12,7	-
2302156	I2LLB0-019	19,0	-

Box = 100 pieces

Dimensions shown may be changed without prior notice

// WORM GEAR CLAMP**// WORM GEAR CLAMP****Clamp - 1 bolt - DIN 3017 - W1 (Plated steel)**

Item Code	Product Code	Hose OD (min)	Hose OD (max)	Clamp Width
		mm	mm	mm
2304156	I1LP1AD-01609	8,0	16,0	9,0
2304157	I1LP1AD-02209	12,0	22,0	9,0
2304159	I1LP1AD-02712	16,0	27,0	12,0
2304162	I1LP1AD-03212	20,0	32,0	12,0
2304163	I1LP1AD-04012	25,0	40,0	12,0
2304164	I1LP1AD-04512	30,0	45,0	12,0
2304165	I1LP1AD-05012	32,0	50,0	12,0
2304166	I1LP1AD-06012	40,0	60,0	12,0
2304167	I1LP1AD-07012	50,0	70,0	12,0
2304168	I1LP1AD-08012	60,0	80,0	12,0
2304169	I1LP1AD-09012	70,0	90,0	12,0
2304170	I1LP1AD-10012	80,0	100,0	12,0
2304172	I1LP1AD-11012	90,0	110,0	12,0
2304173	I1LP1AD-13012	110,0	130,0	12,0
2304174	I1LP1AD-15012	130,0	150,0	12,0
2306217	I1LP1AD-16012	140,0	160,0	12,0
2304175	I1LP1AD-18012	160,0	180,0	12,0
2304176	I1LP1AD-20012	180,0	200,0	12,0
2304177	I1LP1AD-22012	200,0	220,0	12,0
2304178	I1LP1AD-24012	220,0	240,0	12,0

// WORM GEAR CLAMP**Clamp - 1 bolt - DIN 3017 - W5 (Stainless steel 316)**

Item Code	Product Code	Hose OD (min)	Hose OD (max)	Clamp Width
		mm	mm	mm
2304181	I3LP1AD-01609	8,0	16,0	9,0
2304182	I3LP1AD-02209	12,0	22,0	9,0
2304030	I3LP1AD-02712	16,0	27,0	12,0
2304032	I3LP1AD-03212	20,0	32,0	12,0
2304033	I3LP1AD-04012	25,0	40,0	12,0
2304034	I3LP1AD-04512	30,0	45,0	12,0
2304035	I3LP1AD-05012	32,0	50,0	12,0
2304036	I3LP1AD-06012	40,0	60,0	12,0
2304037	I3LP1AD-07012	50,0	70,0	12,0
2304038	I3LP1AD-08012	60,0	80,0	12,0
2304039	I3LP1AD-09012	70,0	90,0	12,0
2304040	I3LP1AD-10012	80,0	100,0	12,0
2304041	I3LP1AD-11012	90,0	110,0	12,0
2304042	I3LP1AD-13012	110,0	130,0	12,0
2304043	I3LP1AD-16012	140,0	160,0	12,0
2304044	I3LP1AD-18012	160,0	180,0	12,0
2304045	I3LP1AD-20012	180,0	200,0	12,0
2304046	I3LP1AD-22012	200,0	220,0	12,0
2304047	I3LP1AD-24012	220,0	240,0	12,0

// SUPERCLAMP

// SUPERCLAMP

Clamp - 1 bolt - W1 (Plated steel)



Item Code	Product Code	Hose OD (min)	Hose OD (max)	Clamp Width
		mm	mm	mm
2303161	I1LP10-01918	17,0	19,0	18,0
2303162	I1LP10-02218	20,0	22,0	18,0
2303163	I1LP10-02518	23,0	25,0	18,0
2303164	I1LP10-02818	26,0	28,0	18,0
2302041	I1LP10-03121	29,0	31,0	21,0
2302042	I1LP10-03521	32,0	35,0	21,0
2302043	I1LP10-03921	36,0	39,0	21,0
2302044	I1LP10-04321	40,0	43,0	21,0
2302045	I1LP10-04721	44,0	47,0	21,0
2302046	I1LP10-05121	48,0	51,0	21,0
2302047	I1LP10-05521	52,0	55,0	21,0
2302048	I1LP10-05921	56,0	59,0	21,0
2302026	I1LP10-06321	60,0	63,0	21,0
2302027	I1LP10-06721	64,0	67,0	21,0
2302028	I1LP10-07324	68,0	73,0	24,0
2302029	I1LP10-07924	74,0	79,0	24,0
2302030	I1LP10-08524	80,0	85,0	24,0
2302031	I1LP10-09124	86,0	91,0	24,0
2302032	I1LP10-09724	92,0	97,0	24,0
2302033	I1LP10-10324	98,0	103,0	24,0
2302034	I1LP10-11224	104,0	112,0	24,0
2302035	I1LP10-12124	113,0	121,0	24,0
2302036	I1LP10-13026	122,0	130,0	26,0
2302037	I1LP10-13926	131,0	139,0	26,0
2302038	I1LP10-14826	140,0	148,0	26,0
2302039	I1LP10-16126	149,0	161,0	26,0
2302040	I1LP10-17426	162,0	174,0	26,0

Dimensions shown may be changed without prior notice

// SUPERCLAMP

Clamp - 1 bolt - W4 (Stainless steel 304)



Item Code	Product Code	Hose OD (min)	Hose OD (max)	Clamp Width
		mm	mm	mm
2303165	I2LP10-01918	17,0	19,0	18,0
2303166	I2LP10-02218	20,0	22,0	18,0
2303167	I2LP10-02518	23,0	25,0	18,0
2303168	I2LP10-02818	26,0	28,0	18,0
2302402	I2LP10-03121	29,0	31,0	21,0
2302049	I2LP10-03521	32,0	35,0	21,0
2301826	I2LP10-03921	36,0	39,0	21,0
2301760	I2LP10-04321	40,0	43,0	21,0
2302403	I2LP10-04721	44,0	47,0	21,0
2302050	I2LP10-05121	48,0	51,0	21,0
2301761	I2LP10-05521	52,0	55,0	21,0
2301762	I2LP10-05921	56,0	59,0	21,0
2301763	I2LP10-06321	60,0	63,0	21,0
2302404	I2LP10-06721	64,0	67,0	21,0
2302405	I2LP10-07324	68,0	73,0	24,0
2302234	I2LP10-07924	74,0	79,0	24,0
2302406	I2LP10-08524	80,0	85,0	24,0
2302051	I2LP10-09124	86,0	91,0	24,0
2302407	I2LP10-09724	92,0	97,0	24,0
2302408	I2LP10-10324	98,0	103,0	24,0
2302409	I2LP10-11224	104,0	112,0	24,0
2302411	I2LP10-12124	113,0	121,0	24,0
2302412	I2LP10-13026	122,0	130,0	26,0
2302413	I2LP10-13926	131,0	139,0	26,0
2302414	I2LP10-14826	140,0	148,0	26,0
2302415	I2LP10-16126	149,0	161,0	26,0
2302416	I2LP10-17426	162,0	174,0	26,0

// PW-CLAMP**// PW-CLAMP****Clamp - 1 bolt - W1 (Plated steel)**

Item Code	Product Code	Hose OD (min)	Hose OD (max)	Clamp Width
		mm	mm	mm
2304220	-	31,0	35,0	20,0
2304222	-	35,0	40,0	20,0
2304224	-	40,0	45,0	20,0
2304225	-	44,0	50,0	20,0
2304226	-	49,0	55,0	20,0
2304227	-	54,0	60,0	20,0
2304229	I1LP1PW-06520	59,0	65,0	20,0
2304230	-	64,0	70,0	20,0
2304231	-	69,0	75,0	20,0

// PW-CLAMP**Clamp - 1 bolt - W5 (Stainless steel 316)**

Item Code	Product Code	Hose OD (min)	Hose OD (max)	Clamp Width
		mm	mm	mm
2304098	-	31,0	35,0	20,0
2304099	-	35,0	40,0	20,0
2304100	-	40,0	45,0	20,0
2304761	I3LP10-04720	43,0	47,0	20,0
2304101	-	44,0	50,0	20,0
2304102	-	49,0	55,0	20,0
2304767	-	55,0	60,0	20,0

Dimensions shown may be changed without prior notice

// PW-CLAMP

Clamp - 2 bolts - W1 (Plated steel)



Item Code	Product Code	Hose OD (min)	Hose OD (max)	Clamp Width
		mm	mm	mm
2304240	-	40,0	50,0	20,0
2304241	-	45,0	55,0	20,0
2304242	-	50,0	60,0	20,0
2304243	-	55,0	65,0	20,0
2304244	-	60,0	70,0	20,0
2304245	-	65,0	75,0	20,0
2304246	-	70,0	80,0	20,0
2304247	-	75,0	85,0	20,0
2304248	-	80,0	90,0	20,0
2304250	-	85,0	95,0	20,0
2304251	-	90,0	100,0	25,0
2304252	-	95,0	105,0	25,0
2304253	-	100,0	110,0	25,0
2304254	-	105,0	115,0	25,0
2304255	-	110,0	120,0	25,0
2304256	-	115,0	125,0	25,0
2304257	-	120,0	130,0	25,0
2304258	-	125,0	135,0	25,0
2304259	-	130,0	140,0	25,0
2305983	-	135,0	145,0	25,0
2304260	-	140,0	150,0	25,0
2304261	-	150,0	160,0	25,0
2304262	-	160,0	170,0	25,0
2304263	-	170,0	180,0	25,0
2304264	-	180,0	190,0	25,0
2304265	-	190,0	200,0	25,0
2304266	-	200,0	210,0	25,0
2304267	-	210,0	220,0	25,0
2304268	-	220,0	230,0	25,0
2304766	-	230,0	240,0	25,0
2305986	-	240,0	250,0	25,0
2304271	-	250,0	260,0	25,0
2305987	-	260,0	270,0	25,0
2306207	-	270,0	280,0	25,0
2304273	-	295,0	305,0	25,0

// PW-CLAMP

Clamp - 2 bolts - W5 (Stainless steel 316)



Item Code	Product Code	Hose OD (min)	Hose OD (max)	Clamp Width
		mm	mm	mm
2304107	-	40,0	50,0	20,0
2304109	-	50,0	60,0	20,0
2304110	I3LP20-06520	55,0	65,0	20,0
2304111	-	60,0	70,0	20,0
2304112	-	65,0	75,0	20,0
2304113	I3LP20-08020	70,0	80,0	20,0
2304114	I3LP20-08520	75,0	85,0	20,0
2304115	I3LP20-09020	80,0	90,0	20,0
2304116	-	85,0	95,0	20,0
2304117	-	90,0	100,0	25,0
2304118	-	95,0	105,0	25,0
2304119	-	100,0	110,0	25,0
2304120	-	105,0	115,0	25,0
2304121	-	110,0	120,0	25,0
2304122	-	115,0	125,0	25,0
2304123	-	120,0	130,0	25,0
2304124	-	125,0	135,0	25,0
2304125	-	130,0	140,0	25,0
2304126	-	140,0	150,0	25,0
2304128	-	150,0	160,0	25,0
2304130	-	160,0	170,0	25,0
2304131	-	170,0	180,0	25,0
2304772	-	180,0	190,0	25,0
2304344	-	190,0	200,0	25,0
2304132	-	200,0	210,0	25,0
2304133	I3LP20-22025	210,0	220,0	25,0
2304134	-	220,0	230,0	25,0

Dimensions shown may be changed without prior notice

// SAFETY CLAMP EN 14 420-3 / DIN 2817**// SAFETY CLAMPS EN 14 420-3 / DIN 2817****Safety clamps - Aluminium**

Item Code	Product Code	Hose ID	Hose ID	Hose OD (min)	Hose OD (max)
		in	mm	mm	mm
2302729	I5LG4D-013023	1/2"	13,0	22,0	24,0
2302730	I5LG4D-019031	3/4"	19,0	30,0	33,0
2302731	I5LG4D-025037	1"	25,0	36,0	39,0
2302015	I5LG4D-032044	1 1/4"	32,0	43,0	46,0
2302016	I5LG4D-038051	1 1/2"	38,0	50,0	52,0
2304819	I5LG4D-038055	1 1/2"	38,0	53,0	56,0
2304095	I5LG4D-051069	2"	50,0	69,0	71,0
2302017	I5LG4D-051066	2"	51,0	64,0	67,0
2301675	I5LG4D-063080	2 1/2"	63,0	78,0	82,0
2302018	I5LG4D-076091	3"	76,0	89,0	93,0
2302732	I5LG4D-080096	3"	76,0	94,0	97,0
2304096	I5LG4D-076099	3"	76,0	98,0	101,0
2302019	I5LG4D-102117	4"	102,0	114,0	119,0
2304097	I5LG4D-100120	4"	102,0	118,0	122,0
2302233	I5LG4D-127146	5"	127,0	143,0	148,0
2302020	I5LG4D-152171	6"	152,0	168,0	174,0
2302021	I5LG4D-203226	8"	203,0	222,0	229,0

// SAFETY CLAMPS EN 14 420-3 / DIN 2817**Safety clamps - Stainless steel 316**

Item Code	Product Code	Hose ID	Hose ID	Hose OD (min)	Hose OD (max)
		in	mm	mm	mm
2304094	I3LG4D-019031	3/4"	19,0	30,0	33,0
2302660	I3LG4D-025037	1"	25,0	36,0	39,0
2302022	I3LG4D-032044	1 1/4"	32,0	43,0	46,0
2302023	I3LG4D-038051	1 1/2"	38,0	50,0	52,0
2302024	I3LG4D-051066	2"	51,0	64,0	67,0
2301676	I3LG4D-063080	2 1/2"	63,0	78,0	82,0
2301759	I3LG4D-076091	3"	76,0	89,0	93,0
2302025	I3LG4D-102117	4"	102,0	114,0	119,0

// SAFETY CLAMPS FLEXOLINE®**// SAFETY CLAMPS FLEXOLINE®****Safety clamps - Aluminium**

Item Code	Product Code	Hose ID	Hose ID	Hose OD (min)	Hose OD (max)
		in	mm	mm	mm
2306570	I5LG4N-025035	1"	25,0	34,0	36,0
2307051	I5LG4N-032042	1 1/4"	32,0	41,0	43,0
2307052	I5LG4N-038048	1 1/2"	38,0	47,0	49,0
2304822	I5LG4N-051060	2"	51,0	59,0	61,0
2304823	I5LG4N-063075	2 1/2"	63,0	74,0	76,0
2304824	I5LG4N-076087	3"	76,0	86,0	88,0
2305871	I5LG4N-102114	4"	102,0	112,0	114,0

To be used with thin-wall hoses for which "Safety clamps EN 14 420-3 / DIN 2817" are too big and not suitable

Dimensions shown may be changed without prior notice

// DOUBLE BOLT CLAMP WITH SADDLES

// DOUBLE BOLT CLAMP WITH TWO SADDLES

Clamp - DIN 20039 A - Malleable iron



Item Code	Product Code	Hose ID	Hose ID	Hose OD (min)	Hose OD (max)
		in	mm	mm	mm
2303170	I9LP20-02900	1/2"	13,0	22,3	28,9
2303171	I9LP20-03400	3/4"	19,0	29,4	34,1
2303172	I9LP20-04000	1"	25,0	32,0	40,0
2303173	I9LP20-04900	1 1/4"	32,0	39,0	49,0
2303174	I9LP20-06000	1 1/2"	38,0	47,6	60,3
2303175	I9LP20-07600	2"	51,0	60,0	76,0
2303176	I9LP20-X9400	2 1/2"	63,0	77,0	94,0

// DOUBLE BOLT CLAMP WITH TWO SADDLES

Clamp - Malleable iron



Item Code	Product Code	Hose ID	Hose ID	Hose OD (min)	Hose OD (max)
		in	mm	mm	mm
2303169	I9LP20-02200	1/2"	13,0	17,0	22,0
2302152	I9LP20-07200	2"	51,0	56,0	72,0
2303177	I9LP20-10200	3"	76,0	89,0	101,0
2303178	I9LP20-11400	3"	76,0	95,2	114,3
2303180	I9LP20-12800	3 1/2"	90,0	114,0	128,0
2303938	I9LP20-14000	4"	102,0	127,0	139,7
2303182	I9LP20-15500	4"	102,0	135,0	155,0
2303184	I9LP20-17500	5"	127,0	155,0	175,0
2303940	I9LP20-19400	6"	152,0	176,2	193,7
2303186	I9LP20-22500	7"	178,0	209,5	225,4
2303942	I9LP20-25100	8"	203,0	227,0	250,8

// DOUBLE BOLT CLAMP WITH TWO SADDLES

Clamp - Plated steel



Item Code	Product Code	Hose ID	Hose ID	Hose OD (min)	Hose OD (max)
		in	mm	mm	mm
2303941	I1LP20-20800	7"	178,0	195,3	208,0
2303943	I1LP20-28900	-	225,0	252,4	288,9

// RUBBER LINED PIPE CLIP**// RUBBER LINED PIPE CLIP****Clip - DIN 3016 - EPDM/W1 (Plated steel)**

Item Code	Product Code	Hose OD (min)	Hose OD (max)	Clamp Width
		mm	mm	mm
2304068	IALP1D-00615	6,0	6,0	15,0
2304069	-	8,0	8,0	15,0
2304065	-	10,0	10,0	12,0
2304070	-	10,0	10,0	15,0
2304066	-	12,0	12,0	12,0
2304071	-	13,0	13,0	15,0
2305178	-	15,0	15,0	12,0
2304072	-	16,0	16,0	15,0
2304073	-	18,0	18,0	15,0
2304074	-	20,0	20,0	15,0
2304079	-	25,0	25,0	20,0
2304080	-	30,0	30,0	20,0
2304083	-	35,0	35,0	25,0
2304084	-	40,0	40,0	25,0
2304086	IALP1D-05025	50,0	50,0	25,0

Rubber lined clips in EPDM / W4 (S/S 304) available on request

// RUBBER LINED PIPE CLIP**Clip - SMS - EPDM/W1 (Plated steel)**

Item Code	Product Code	Hose OD (min)	Hose OD (max)	Clamp Width
		mm	mm	mm
2304702	-	6,4	6,4	12,7
2304703	-	7,9	7,9	12,7
2304704	-	9,5	9,5	12,7
2304707	IALP1S-01219	11,1	11,1	12,7
2304708	-	12,7	12,7	12,7
2304050	-	15,9	15,9	12,7
2304051	-	19,0	19,0	12,7
2305951	-	20,6	20,6	12,7
2304713	-	22,2	22,2	12,7
2304716	-	25,4	25,4	12,7
2304719	-	28,6	28,6	12,7
2304721	-	31,8	31,8	12,7
2304723	-	34,9	34,9	12,7
2304725	-	38,1	38,1	12,7
2304727	-	44,5	44,5	12,7
2304729	-	51,0	51,0	12,7
2304730	-	65,0	65,0	12,7



// FERRULE & CRIMPING RING

// CRIMPING RING	298
// SMOOTH FERRULE.....	299
// SERRATED FERRULE.....	300

// CRIMPING RING

// R5YBFF0

Crimping ring - Aluminium



Item Code	Product Code	Ferrule ID	Ferrule OD	L
		mm	mm	mm
2303033	R5YBFF0-0242020	24,00	28,0	20,0
2303034	R5YBFF0-0312020	31,00	35,0	20,0
2303035	R5YBFF0-0402520	40,00	45,0	20,0
2306680	R5YBFF0-0552530	55,00	60,0	30,0
2304550	R5YBFF0-0602535	60,00	65,0	35,0
2304551	R5YBFF0-0902540	90,00	95,0	40,0
2306888	R5YBFF0-0952575	95,00	100,0	75,0
2303040	R5YBFF0-1102560	110,00	115,0	60,0
2304552	R5YBFF0-1252580	125,00	130,0	80,0

For crimping rings in different dimensions, see "R5YBFF0-M": consult chapter "Mortar"

CRIMPING RING Code	Hose family	Hose ID mm	Hose OD mm	Ring ID mm	INSERT Code
R5YBFF0-0242020	180AA	13	19	24	I818A300-013040 GEKA INSERT ID13 I819E300-013041 EXPRESS-INSERT-ID13
	284AA	13	19		
	185AA	13	21		
R5YBFF0-0312020	180AA	19	27	31	I818A300-019040 GEKA INSERT ID19 I819E300-019041 EXPRESS-INSERT-ID19
	284AA	19	26		
	185AA	19	28		
R5YBFF0-0402520	180AA	25	34	40	I818A300-025040 GEKA INSERT ID25 I819E300-025041 EXPRESS-INSERT-ID25
	284AA	25	33		
	185AA	25	35		
	175AA	25	35		
R5YBFF0-0452550	757AA	25	38	45	Ix38Cxxx-025xxx INN.MORTAR I1306100-025034 INS.MORTAR DN25 BSPP 1" P24
R5YBFF0-0552555	757AA	35	49	55	Ix38Cxxx-035xxx INN.MORTAR I1306100-035042 INS.MORTAR DN35 BSPP 1 1/4 P34
R5YBFF0-0552530	764OL	45	54	55	I519Z300-045052 STORZ ALU 52-C ID45
R5YBFF0-0602535	212AA	45	55	60	I5191300-045040 SYMMETRIC INSERT AL ID45 DN40
R5YBFF0-0752555	757AA	51	67	75	Ix38Cxxx-05xxxx INN.MORTAR I1306100-051060 INS.MORTAR DN51 BSPP 2" P47
	737AA	51	69		
R5YBFF0-0902540	212AA	70	82	90	I5191300-070085 SYMMETRIC INSERT AL ID70 DN65
R5YBFF0-0952575	605AA	76	88	95	I519C200-076076 INS.C&G TYPE C 3" AL
R5YBFF0-1102560	760AA	90	102	110	I5191300-090080 SYMMETRIC INSERT AL ID90 DN80
	760LA	90	102		
	472OO	90	104		
R5YBFF0-1252580	472OO	105	121	125	I5191300-105100 SYMMETRIC INSERT AL ID105 DN100 I5192300-110100 SYMMETRIC INSERT AR AL 100X110
	212AA	110	122		

Dimensions shown may be changed without prior notice

// SMOOTH FERRULE

// I505C5

Smooth ferrule - Aluminium

Item Code	Product Code	Hose ID	Hose ID	Hose OD (min)	Hose OD (max)
		in	mm	mm	mm
2300891	I505C5-040	1 9/16"	40,0	46,0	54,0
2301751	I505C5-050	2"	50,0	61,0	64,0
2300099	I505C5-065	2 9/16"	65,0	73,0	81,0
2300917	I505C5-080	3 1/8"	80,0	86,0	94,0
2300892	I505C5-100	4"	100,0	112,0	120,0

// I205C5

Smooth ferrule - Stainless steel 304

Item Code	Product Code	Hose ID	Hose ID	Hose OD (min)	Hose OD (max)
		in	mm	mm	mm
2300847	I205C5-020	3/4"	19,0	27,0	33,0
2300848	I205C5-025	1"	25,0	33,0	39,0
2300849	I205C5-032	1 1/4"	32,0	40,0	48,0
2300850	I205C5-040	1 9/16"	40,0	46,0	54,0
2300851	I205C5-050	2"	50,0	61,0	65,0
2300852	I205C5-065	2 9/16"	65,0	73,0	81,0
2300853	I205C5-080	3 1/8"	80,0	86,0	94,0
2300854	I205C5-100	4"	100,0	112,0	118,0

// SERRATED FERRULE

// I307U-RK

Serrated ferrule - Stainless steel 316



Item Code	Product Code	Hose ID	Hose ID	Hose OD (min)	Hose OD (max)
		in	mm	mm	mm
2303961	I307U038-049053	1 1/2"	38,0	49,0	53,0
2303962	I307U051-064067	2"	51,0	64,0	67,0
2303963	I307U051-068074	2"	51,0	68,0	74,0
2304503	I307U063-079082	2 1/2"	63,0	79,0	82,0
2303964	I307U063-087091	2 1/2"	63,0	87,0	91,0
2304504	I307U076-089092	3"	76,0	88,5	92,5
2303965	I307U076-099000	3"	76,0	95,0	101,0
2304556	I307U102-117122	4"	102,0	117,0	122,0
2303966	I307U102-128135	4"	102,0	128,0	135,0



// APPENDIX

// CHEMICAL RESISTANCE CHART	308
// PVC CHEMICAL RESISTANCE CHART	322
// INDUSTRIAL FITTINGS MANUAL	324
// INDUSTRIAL HOSE & RACOMMENDED FITTING TABLES.....	351

// CHOICE, STORAGE, USE & MAINTENANCE

1. CHOICE CRITERIA

In order to choose a hose suitable for a specific use it is necessary to determine at least the following basic points:

1.1 Pressure - suction

It is necessary to determine the maximum working pressure or suction values. It should be taken into consideration that the normal life of the hose will be prejudiced in the case of a sudden pressure variation or pressure peaks exceeding the maximum allowed.

1.2 Compatibility of conveyed substances

The nature, designation, concentration, temperature and state (liquid, solid, gaseous) must be determined. In the case of solid substances conveyed, it is necessary to indicate granulometry, density, quantity of the solid substance conveyed as well as the nature, speed and flow of the fluid carrying it.

1.3 Environment

The nature, designation, concentration, temperature and state (liquid, solid, gaseous) must be determined. In the case of solid substances conveyed, it is necessary to indicate granulometry, density, quantity of the solid substance conveyed as well as the nature, speed and flow of the fluid carrying it.

1.4 Mechanical stress

The minimum bend radius* must be established as well as any stress related to traction, torsion, bending, vibration, compression, deflection and longitudinal or transversal loads.

1.5 Cover abrasion

Even though the hoses are manufactured to guarantee good resistance to abrasion, it is advisable to use further protection when damage to the hose may be caused by shock, corrosion and/or dragging.

1.6 Working position

Indicate if the hose is either placed on the ground, suspended or immersed.

1.7 Used or foreseen couplings

This must be selected according to:

- couplings and flanges: type, dimension, type of thread, standard references and kind of application;
- hose shank: internal and external diameter and length;
- ferrules/clumps: type and dimension.

In order to guarantee good performance the compatibility between the hose and type of coupling must be ensured.

The assembly must guarantee the working pressure suggested by the manufacturer.

1.8 Technical standards

National, European and International technical standards and rules must always be adhered to. In the case of hoses for peculiar purposes it is advisable to establish proper specification with the manufacturer.

1.9 Marking

Manufacturers must mark hoses at regular intervals with the information necessary for the proper use of the product. When interpretation is not clear or information is insufficient, user should apply to the manufacturer.

* The minimum bend radius is the radius to which the hose can be bent in service without damage or appreciably shortening its life. The radius is measured to the inside of the curvature. Formula to determine minimum hose length given bend radius and degree of bend required:

$$L = \frac{A}{360^\circ} \times 2 \pi B$$

Where:

- L = Minimum length of hose to make bend (Bend must be made equally along this portion of hose length).
- A = Angle of bend
- B = Given bend radius of hose
- $\pi = 3.14$

Example: To make a 60° bend at the hose's rated minimum bend radius of 15 cm

$$L = \frac{60}{360^\circ} \times 2 \times 3.14 \times 15 = 15.7 \text{ cm} \cong 16 \text{ cm}$$

Thus, the bend must be made over approximately 16 cm of hose length. The bend radius used must be equal to or greater than the rated minimum bend radius.

Bending the hose to a smaller bend radius than minimum may kink the hose and result in damage and early failure.

(Reprinted from Assogomma "Recommendation regarding choice, storing, use and maintenance of rubber hoses" June 2004.)

2. RECOMMENDATION FOR CORRECT STORAGE

Rubber is subject, by nature, to changes in physical properties. These changes, which normally occur over the course of time, according to the kind of rubber used, can be accelerated by one particular factor or by a combination of these.

Reinforcement materials are also adversely affected by unsuitable conditions of storage. The following recommendations give some precautions to be taken to ensure the minimum deterioration to stored articles.

2.1 Storage life

Storage time should be reduced to the minimum through programme rotation.

When it is not possible to avoid long term storage, it is necessary that the user, as indicated in ISO 8331, carries out a complete check of the hose before its use according to the following criteria:

- maximum two years storage for assembly;
- maximum four years storage for hoses.

2.2 Temperature and humidity

The best temperature for the storage of rubber hoses varies from 10 to 25 degrees centigrade. Hoses should not be stored at temperature above 40 °C or below 0 °C. When the temperature is below -15 °C it is necessary to take precautions when handling.

Hoses should not be stored near sources of heat nor in conditions of high or low humidity. A humidity level of a maximum of 65% is recommended.

2.3 Light

Hoses must be stored in dark places, avoiding direct sun light or strong artificial light. Should store rooms have windows or glass openings, these must be screened.

2.4 Oxygen and ozone

Hoses should be protected from circulating air by suitable packing or by storage in air-tight containers. As ozone has a particularly aggressive action on all rubber products, the store house must not contain material producing ozone like devices under high electrical tension, electric engines or other materials provoking sparks or electric arcs.

2.5 Contact with other materials

Hoses should not come into contact with solvents, fuels, oils, greases, volatile chemical mixtures, acids, disinfectants and other organic liquids in general.

Furthermore direct contact with some metals (for example manganese, iron, copper and its alloys) and relative mixture exercise harmful effects on some types of rubber.

Contact with PVC and creosote impregnated timber or fabrics should be avoided.

2.6 Heat sources

The temperature limits given in point 2.2 must be respected. When this is impossible, it is necessary to use a thermic shield at a distance not less than one meter.

2.7 Electric or magnetic field

Variation in electric or magnetic fields must be eliminated in store houses as these could provoke currents in metal coupling, heating them. Similar fields could be caused by high-tension cables or high frequency generators.

2.8 Storage conditions

Hoses must be stored in a relaxed condition free from tension, compression or other deformation and contact with objects that could pierce or cut must be avoided. It is preferable to store hoses on special shelves or on dry surfaces.

Coiled hoses must be stored horizontally avoiding piling. When this is not possible the height of the piles must be such to avoid permanent deformation of hoses stored underneath. The inside diameter of the coil, during the storage, must be such as to not compromise the performances of the products. In particular, this diameter must not have value less than those indicated by the manufacturers.

The inside diameter of the coil, during the storage, must be such as to not compromise the performances of the products. In particular, this diameter must not have value less than those indicated by the manufacturers.

2.9 Rodents and insects

Hoses must be protected from rodents and insects. When such a risk is probable adequate precautions must be taken.

2.10 Marking or packaged items

It is advisable that hoses are always easy to identify even if packaged.

2.11 Exit from storage

Prior to delivery hoses must be checked for integrity and must correspond to the required use. After long storage if couplings are not clipped, swaged or built-in, it is necessary to check that locking collars are tight.

2.12 Return to storage

Hoses that have been used must be free from all substances prior to storage. Particular attention must be paid when chemical, explosive, inflammable, abrasive and corrosive substances have been conveyed.

After cleaning, check whether the hose is suitable to use again.

3. NORMS AND METHOD OF USE

After having chosen the type of hose, the users must keep in mind the following hose installation criteria:

3.1 Preassembly checks

Prior to installation it is necessary to check the characteristics of the hose carefully to verify that type, diameter and length conform with the required specifications. Moreover a visual check must be effected to make sure that there are no obstructions, cuts, damaged cover or any other evident imperfections.

3.2 Handling

Hoses must be moved with care avoiding knocks, dragging over abrasive surfaces and compression. Hoses must not be pulled violently when twisted or knotted. Heavy hoses, normally delivered in a straight line, must be laid on special supports for transport (see attachment). Should wood supports be used these must not be treated with creosote or painted with substances which could damage the rubber.

3.3 Pressure and seal test

The working pressure generally indicated by manufacturer must be respected. Following installation, when air bubbles have been eliminated, increase the pressure to test the assembly and check possible leaks. This test must be carried out in a place free from danger.

3.4 Temperature

Hoses must always be used within the temperature limits generally indicated. In case of doubt apply to manufacturers.

3.5 Conveyed products

Hoses must be used exclusively to convey substances for which they were manufactured. In case of doubt it is always advisable to contact manufacturer. As far as possible, hoses must be empty after usage. Where any risks are involved special precautions must be taken to avoid bursts.

3.6 Environment

Hoses must be used exclusively in the environment conditions for which they were manufactured.

3.7 Bending radius

Installation underneath the minimum bending radius reduces the life of the hose considerably. Moreover it is necessary to avoid bending at fitting ends. *(See attached 1).

3.8 Torsion

Hoses are not manufactured to work in torsion, except for specific purposes.

3.9 Traction

Traction must be within limits specified by manufacturer. In case of doubts it's advisable to get in touch with manufacturers.

3.10 Vibration

Vibrations subject hoses to stress from heat and fatigue above all near couplings and premature bursting may occur. It is therefore advisable to check that hoses have been manufactured to resist such stress.

3.11 Kinking

Some users tend to obstruct the flow of liquids by kinking the hose. This system is not advised by manufacturers because the reinforcement is subjected to excessive stress and could lead to bursting.

3.12 Choice and application of couplings

Provided that the manufacturers instructions are met it is always necessary to check the compatibility between the working pressure of couplings and hoses. Couplings with too large diameters cause abnormal stress which can split the hose reinforcement, whilst too small dimensions can create clumping difficulties and leakage.

Furthermore couplings must be free from sharp and cutting edges which could damage the hose.

Water or soap and water can be used to fit couplings. Do not use products containing oils or solvents except for the kind of hoses destined to be used with the latter.

Softening hoses with mallet or similar tools is forbidden.

Take care to avoid external collars or other tightening tools. The use of makeshift collars (for example wire) with sharp edges or too tight clumping leads to damage of cover and reinforcement.

3.13 Electrical properties

According to ISO 8031: 2009 "Rubber and plastics hoses and hose assemblies – Determination of electrical resistance and conductivity" hoses and hose assemblies are classified in three types depending on their property to conduct electricity:

a) INSULATING

Not incorporating conductive elements and not capable of dissipating electrostatic charges.

The electrical resistance is more than $10^8 \Omega$ per length.

b) CONDUCTIVE (Ω grade)

Incorporating electrically conducting materials in the hose construction.

The resistance along the conductive layer, in case of hoses, or the resistance between fittings, in case of hose assemblies, shall not exceed $10^6 \Omega$ per length.

c) ELECTRICALLY BONDED (grade M)

Incorporating at least two metallic bonding wires into the hose construction. The resistance along the bonding wires, in case of hoses, or the resistance between fittings, in case of hose assemblies, shall not exceed $10^2 \Omega$ per length.

According to EN 12115: 2011 “ Rubber and thermoplastics hoses and hose assemblies for liquid or gaseous chemicals – specification”, when there is a need for hose assemblies of type b) or c) with an electrical resistance through the hose wall of not more than 10^9 , these hoses shall be marked with the additional symbol “/T”, e.g. “Ω/T” or “M/T”.

Such hose assemblies are required in situations where dissipation of electrostatic charges are a safety requirement (i.e. in explosive environments).

3.14 Installation between two points

The hoses must be supported in a suitable way, so as the normal movement when the hose is under pressure (variations in length, diameter, twisting, etc.) are allowed.

3.15 Mobile pieces

When hoses link mobile pieces, it is necessary to check that the length of the hose is suitable and that the movement does not subject the hose to shock or chafing and that abnormal stress, bending, traction or torsion do not occur.

3.16 Identification

If further marking is necessary, self-adhesive tape may be used. When the use of paint is unavoidable check compatibility of cover with manufacturer.

4. MAINTENANCE

Even though choice, storage and installation have been carried out correctly regular maintenance is necessary. Frequency of the latter is determined according to use involved. During regular check special attention must be paid to couplings and to the appearance of the following irregularities which show deterioration of hose:

- Cracks, cuts, abrasions, unsticking, tears in cover revealing reinforcement;
- Deformity, bubbles, local swelling under pressure;
- Sticky or soft areas;
- Leaks.

Such irregularities justify hose substitutions. When cover bears date of expiry this must be kept to even if the hose shows no apparent signs of wear.

4.1 Repairs

Hose repairs are not advisable. However when deterioration occurs at an end section, and if the full length allows for such, the worn section may be eliminated.

4.2 Cleaning

If cleaning instructions are not supplied by the manufacturer clean, if necessary, with soap and water avoiding use of solvents (petrol, paraffin, etc) or detergents. Never use abrasive, pointed or cutting tools (wire brushes).

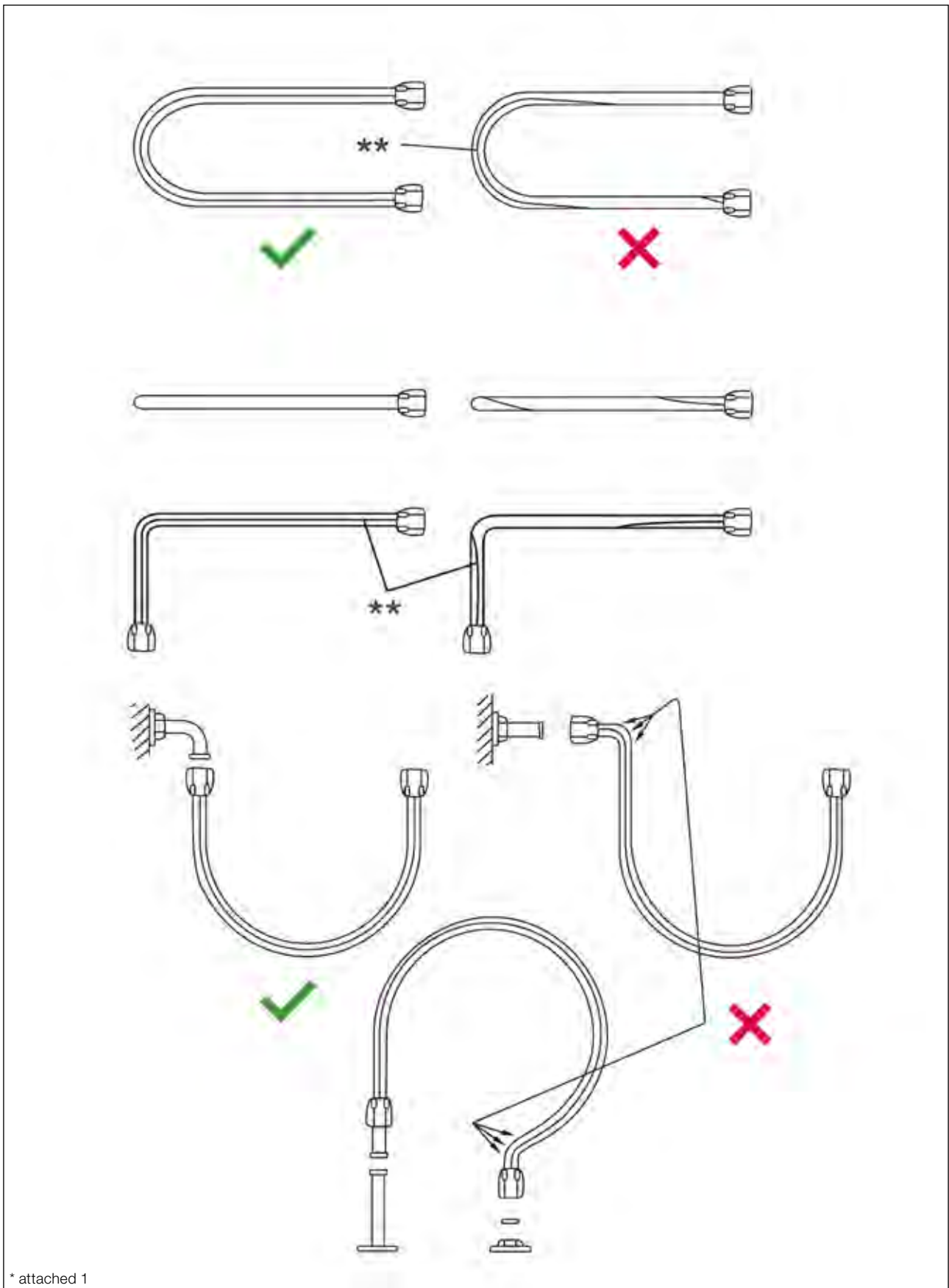

This drawings refer to assemble installed in real conditions. Some of these may request layouts violating such recommendations. It is necessary to point out that such cases are only applicable in test conditions and cannot be used for general use.

** Lay line

// CHEMICAL GUIDE

The chemical guide in this section is offered as a general indication of the compatibility of the various materials used in ALFAGOMMA hose with the chemicals and fluids listed. The basis for the ratings in this guide include actual service experience, the advice of various polymer suppliers, and the considered opinion of our rubber chemists. When in doubt, a sample of the compound should always be tested with the particular chemical it is to handle. Some of the variables that come into play in the resistance of a compound to chemical attack are:

1. Temperature of the Material Transmitted

Higher temperatures increase the effect of chemicals on rubber compounds. The increase varies with the polymer and the chemical. A compound quite suitable at room temperature might fail very quickly at higher temperatures.

2. Service Conditions

A rubber compound usually swells when exposed to a chemical. With a given percent of swell, a hose tube may function satisfactorily if the hose is in a static condition, but fail quickly if the hose is subject to flexing.

3. The Grade or Blend of the Rubber Compound

Basic rubber polymers are sometimes mixed or blended together to enhance a particular property for a specific service. The reaction to a particular chemical blend of polymers may, therefore, be somewhat different from the reaction to the single ones. When in doubt, a sample of the compound should always be tested with the particular chemical it is to handle.

General chemical resistance of alfagomma hose compounds

Common name	ASTM designation D1418-93	Composition	General properties
Natural rubber	NR	Isoprene rubber	Excellent physical properties, including abrasion resistance. Not oil resistant.
SBR	SBR	Styrene-butadiene rubber	Good physical properties, including abrasion resistance. Not oil resistant.
Butyl rubber	IIR	Isobutene-isoprene rubber	Very good weathering resistance. Low permeability to air. Good physical properties. Poor resistance to petroleum based fluids.
EPDM	EPDM	Ethylene-propylene-diene-terpolymer	Good general purpose polymer. Excellent heat, ozone and weathering resistance. Not oil resistant.
Cross linked polyethylene	XLPE	Cross linked polyethylene	Excellent resistance to most solvents, oils and chemicals. Do not confuse with chemical properties of standard polyethylene.
Ultra high molecular weight polyethylene	UPE	Ultra high molecular weight polyethylene	Excellent resistance to most solvents, chemicals and hydrocarbons. Excellent abrasion and wear resistance. Inert and suitable for food contact. Do not confuse with chemical properties of standard polyethylene.
Teflon/Fluorocarbon resin	PTFE	Polytetra-fluoroethylene	Excellent chemical and solvent resistance. Inert to most materials. Smooth anti-adhesive surface, easy to clean.
Nitrile rubber	NBR	Acrylonitrile-butadiene rubber	Excellent oil resistance. Good physical properties.
Neoprene	CR	Chloroprene rubber	Excellent weathering resistance. Flame retardant. Good oil resistance. Good physical properties.
Hypalon®	CSM	Chloro-sulfonated polyethylene	Excellent ozone, weathering and acid resistance. Good abrasion and heat resistance. Can be compounded for good oil resistance.
Polyurethane	AU	Polyester urethane	Excellent abrasion and wear resistance. Not resistant to hydrolysis.
Viton	FKM	Fluorocarbon rubber	Excellent high temperature resistance, particularly in air or oil. Very good resistance to chemicals.

// CHEMICAL RESISTANCE CHART

The following data is based on tests and believed to be reliable; however, we emphasise that the tabulation should be used as a guide only, since it does not take into consideration all variables such as elevated temperatures, fluid contamination, concentration, etc. that may be encountered in actual use. All critical applications should be tested.

Contact ALFAGOMMA for recommendation and assistance.

Note: All data based on 20 °C (68 °F) unless otherwise noted.

Chemical or material conveyed	Compound											
	NR	SBR	IIR	EPDM	XLPE	UPE	PTFE	NBR	CR	CSM	AU	FKM
ACETALDEHYDE	F	X	E	E	E	E	C	X	C	F	X	X
ACETIC ACID, GLACIAL	C	X	G	G	E	E	C	X	F	C	C	X
ACETIC ACID, 10%	G	F	G	E	E	E	C	E	E	E	X	G
ACETIC ACID, 50%	X	F	G	E	E	E	C	F	F	E	X	F
ACETIC ANHYDRIDE	F	X	C	G	E	E	F	X	G	E	F	X
ACETIC OXIDE	F	X	G	G	E	E	F	X	G	E	F	X
ACETONE	C	C	E	E	E	E	X	X	C	X	X	X
ACETONE CYANOHYDRIN	F		E	E				X	G	F	X	X
ACETONITRILE	G		E	E			E	X	E	G		X
ACETOPHENONE	C	X	G	E	E	E	X	X	X	X	X	X
ACETYL ACETONE	X	X	E	E			X	X	X	X	C	X
ACETYL CHLORIDE	X	X	X	X			E	X	X	C	X	G
ACETYL OXIDE	F		G	G	E	E	F	X	G	E	F	X
ACETYLENE	C	F	E	E	E	E	E	E	E	C	C	E
ACETYLENE DICHLORIDE	X	X	F	C			E	X	X	X		G
ACETYLENE TERACHLORIDE	X		X	C			X	X	C	X	X	
ACROLEIN	G	F	E	E				F	G	G	X	C
ACRYLONITRILE	C	F	X	E	E	E	G	X	X	C	X	X
ACRYLIC ACID	X			X			X	X	X	G	C	
ADIPIC ACID	E		X	C	E	E	G	E	E	G	E	E
AIR, +300°F	X	X	G	G			E	G	G	G	C	E
ALK-TRI	X		X	X			X	X	X	X	X	E
ALLYL ALCOHOL	E		E	E	E	E		E	E	E		E
ALLYL BROMIDE	X		X	X				X	X	X		G
ALLYL CHLORIDE	X	E	C	X	E	F	G	G	X	X		E
ALUM	E		E	G	E	E	C	C	E	E	G	E
ALUMINIUM ACETATE	E	X	G	E			E	C	C	F	X	C
ALUMINIUM CHLORIDE	E	E	E	E	E	E	E	E	E	E	C	E
ALUMINIUM FLUORIDE	E	E	E	E	E	E	E	E	E	E	C	E
ALUMINIUM FORMATE	X		G	E				X	E	X	X	X
ALUMINIUM HYDROXIDE	E	G	E	E	E	E	E	E	E	E	G	E
ALUMINIUM NITRATE	E	E	E	E	E	E	E	E	E	E	C	E
ALUMINIUM SULFATE	E	G	A	E	E	E	C	E	G	E	C	E
AMINES-MIXED	C	G		G			G	X	C	X	X	X
AMINO BENZENE	X	X	E	C	E	E	E	X	X	C	X	E
AMINODIMETHILBENZENE	X		G	C				C	X	F		X
AMINOETHANE	C	X	G	E	E	E	E	C	C	F	X	X
AMINOXYLENE	X		G	E			G	C	X	X	X	F
AMMONIUM CARBONATE	E	E	E	E			C	C	E	C	C	E
AMMONIUM CHLORIDE	E	E	E	E	E	E	E	G	E	E	G	E
AMMONIUM HYDROXIDE	G	X	G	E	E	E	E	C	E	E	C	G
AMMONIUM NITRATE	E	E	E	E	E	E	C	E	E	E	C	E
AMMONIUM PHOSPHATE, DIBASIC	E	E	E	E	E	E	C	E	E	E		E
AMMONIUM SULFATE	E	G	E	E	E	E	C	E	E	E	E	E
AMMONIUM SULFIDE	E	G	E	E	E	E	C	C	E	E		X
AMMONIUM THIOSULFATE	E		E	E				C	E	E	X	E
AMYL ACETATE	C	X	G	C	E	E	X	X	X	X	X	X
AMYL ACETONE	X		G	G				X	X	X		X
AMYL ALCOHOL	C	G	E	E	E	E	E	C	C	E	X	E
AMYL BROMIDE	X		X	C				X	X	X		G
AMYL CHLORIDE	X	X	X	X	E	E	E	X	X	X	F	E
AMYL ETHER	X		X	X				C	X	F		
AMYLAMINE	F		G	X				F	C	F		C
ANETHOLE	X		X	X				X	X	X		G

Blank = No data E = Excellent G = Good F = Fair C = Conditional X = Unsatisfactory

Chemical or material conveyed	Compound											
	NR	SBR	IR	EPDM	XLPE	UPE	PTFE	NBR	CR	CSM	AU	FKM
ANILINE	X	X	E	G	E	E	E	X	X	C	X	E
ANILINE DYES	C	G	G	C	E	E	C	X	C	G	X	G
ANILINE OIL	X	X	G	C	E	E	G	X	X	C	X	F
ANIMAL FATS	X	X	C	C	E	E	E	E	C	F	F	E
ANTIMONY PENTACHLORIDE	X			C	E	E		X	C	X	E	
AQUA REGIA	X	X	C	C	X	X	C	X	X	C	X	E
ARGON	X	C	G	E			E	E	G	X	C	E
ARSENIC ACID	E	E	E	E	E	E	E	E	E	E	C	E
ASPHALT	X	X	X	X	E	E	E	C	C	F	G	E
ASTM FUEL A	X	X	X	X			F	E	C	C	E	E
ASTM FUEL B	X	X	X	X			X	C	X	X	C	E
ASTM FUEL C	X	X	X	X			X	C	X	X	X	E
ASTM OIL NO.1	X	X	X	X	E	E	E	E	E	C	E	E
ASTM OIL NO.2	X	X	X	X	E	E	G	E	C	X	C	E
ASTM OIL NO.3	X	X	X	X	E	E	G	E	C	C	C	E
ASTM OIL NO.4	X	X	X	X			G	C	X	X	X	E
AUTOMATIC TRANSMISSION FLUID	X	X	X	X			C	E	C	C	C	E
BANANA OIL	X		C	C			X	X	X	C	X	X
BARIUM CHLORIDE	E	E	E	E	E	E	E	E	E	E	E	E
BARIUM HYDROXIDE	E	E	E	E	E	E	E	E	E	E	E	E
BARIUM SULPHIDE	E	G	E	E	E	E	E	E	E	E	E	E
BEER	E	E	E	E	E	E	E	E	E	E	C	E
BEET SUGAR LIQUORS	E	E	E	E	E	E	E	E	C	E	X	E
BENZAL CHLORIDE			G					X				
BENZALDEHYDE	X	X	G	E	E	E	C	X	X	X	X	X
BENZENE	X	X	X	C	E	F	C	X	C	C	X	E
BENZENE CARBOXYLIC ACID	X		E	C			E	X	E	C	X	E
BENZINE		X	X	X	E	E	F	E	C	C	F	E
BENZOIC ACID	X	X	C	C			C	X	E	C	X	E
BENZOL	X	X	X	C	E	F	C	X	C	C	X	E
BENZOTRICHLORIDE	X			E			E	X	X	X		
BENZYL ACETATE	X		E	E				X	E	G	X	X
BENZYL ALCOHOL	X	X	E	C			E	X	C	C	X	E
BENZYL CHLORIDE	X	X	X	X			E	X	X	X	X	C
BENZYL ETHER	X	X	G	C			F	X	X	X	C	X
BLACK SULFATE LIQUOR	G	G	G	G	E	E		G	G	G	X	E
BLEACH	C	X	E	E	G	F	E	X	C	E	C	G
BORAX SOLUTION	C	G	E	E	E	E	E	C	E	E	E	E
BORIC ACID	E	E	E	E	E	E	E	E	E	E	E	E
BRAKE FLUID (HD-557)12 DAYS	X	E	E	E	E	E	E	C	C	C	X	X
BRINE	E		E	E	E	E	E	E	E	E	G	E
BROMACIL												
BROMOBENZENE	X	X	X	X			X	X	X	X	X	E
BROMOCHLOROMETANE	X		C	G	F	F		X	X	X		F
BROMOETHANE	C	X	C	X	E	E	E	C	X	X	X	E
BROMOTOLUENE	X		X					X		X		G
BUNKER OIL	X	X	X	X			E	E	G	C	C	E
BUTADIENE	X	X	X	X	E	E	C	X	X	G	X	E
BUTANE	X	X	X	X	E	E	C	E	E	C	E	E
BUTANOIC ACID	C		X	C			E	C	X	C	C	E
BUTANOL	E	E	C	C	E	E	E	E	E	E	X	E
BUTANONE	X	X	E	E	E	E	X	X	X	X	X	X
BUTOXYETHANOL	X		C	E			F	C	X	G	X	X
BUTYL ACETATE	X	X	C	C	E	E	X	X	X	X	X	X
BUTYL ACRYLATE	X	X	X	C	E	E	X	X	X	X		X
BUTYL ALCOHOL	E	E	C	C	E	E	E	E	E	E	X	E
BUTYL ALDEHYDE	X	X	C	C	E	E	X	X	X	X	C	X
BUTYL BENZYL PHTHALATE	X		E	E	E	E		X	E	X	X	F
BUTYL CARBITOL	X	X	E	E			C	X	X	C	X	F
BUTYL CELLOSOLVE	X	X	C	C	E	E	F	C	X	G	X	X
BUTYL CHLORIDE	X		F	X				X	X	X	E	E
BUTYL ETHER	X	X	C	C	E	E	X	X	C	X	C	X
BUTYL ETHER ACETALDEHYDE	X		G	X				X	X	X		X
BUTYL ETHYL ETHER	X		X	F				G	X	C		
BUTYL OLEATE	X	X	C	C			C	X	X	X		E
BUTYL PHTHALATE	X	X	G	E	E	E	C	X	X	X	X	F
BUTYL STEARATE	X	X	C	X	E	E	C	C	X	X	G	E

Blank = No data E = Excellent G = Good F = Fair C = Conditional X = Unsatisfactory

Chemical or material conveyed	Compound											
	NR	SBR	IIR	EPDM	XLPE	UPE	PTFE	NBR	CR	CSM	AU	FKM
BUTYLENE	X	X	X	X			C	C	C	C	C	E
BUTYRALDEHYDE	X	X	C	C	E	E	X	X	X	X	C	X
BUTYRIC ACID	C	X	X	C	E	E	E	C	X	C	C	G
BUTYRIC ANHYDRIDE	F		F	E				C	G	G	X	
CADMIUM ACETATE	X		E					X		E		X
CALCIUM ALUMINATE	E		E					E		E		E
CALCIUM BICHROMATE			E	E				C	E	F		
CALCIUM BISULFIDE	X	G	X	E			E	C	E	F	C	E
CALCIUM CHLORIDE	E	E	E	E	E	E	E	E	E	E	E	E
CALCIUM HYDROXIDE	E	E	E	E	E	E	E	E	E	E	C	E
CALCIUM HYPOCHLORITE	C	X	E	E	E	E	E	C	C	E	C	E
CALCIUM NITRATE	E	E	E	E			E	E	E	E	E	E
CALCIUM SULFIDE	C	X	E	E			E	E	E	E	C	E
CALCIUM ACETATE	E	X	E	E			C	C	C	C	X	E
CAPRYLIC ACID	C		F					F		G		
CARBAMIDE	E		E	E	E	E	F	G	G	E	G	E
CARBITOL	C	E	C	C	E	E	E	C	C	C	X	E
CARBOLIC ACID PHENOL	C		C				E			C	C	
CARBON DIOXIDE	G	G	E	G	E	E	E	E	G	E	E	E
CARBON DISULFIDE	X		X	X	C	C	C	X	X	X	C	E
CARBON MONOXIDE	C	G	E	E	E	E	E	C	C	C	E	E
CARBON TETRACHLORIDE	X		X	X	E	E	X	X	X	X	C	E
CARBONIC ACID	E	G	E	E	E	E	E	C	E	E	E	E
CASTOR OIL	E	E	C	C	E	E	E	E	E	E	E	E
CAUSTIC SODA	E	E	E	G	E	E	E	C	G	E	C	E
CELLOSOLVE ACETATE	C	X	C	G	E	E	C	X	X	X	C	X
CELLUGUARD	E	E	E	E			E	E	E	E	X	E
CETYLIC ACID	C	G	C	C	E	E	E	E	G	C	C	E
CHINA WOOD OIL	X	X	C	X	E	E	E	E	C	C	C	E
CHLORINATED SOLVENTS	X	X	X	X	E	E	C	X	X	X	X	E
CHLORO-2-PROPANONE	X		C				C			X	X	
CHLOROACETIC ACID	X	X	C	C	E	E	C	X	X	G	X	G
CHLOROACETONE	X	X	C	E	E	E	C	X	X	X	X	X
CHLORO BENZENE	X	X	X	X	E	E	C	X	X	X	X	E
CHLOROBUTANE	X		F	X				X	X	X	E	E
CHLORODANE	X	X	X	X			C	C	C	C	C	E
CHLOROETHYL BENZENE	X		X	X				C	X	X	C	
CHLOROFORM	X	X	X	X	F	F	E	X	X	X	X	E
CHLOROPENTANE	X		X	X			C	X	X	X	F	E
CHLOROSULFONIC ACID	X	X	X	X	F	X	C	X	X	X	X	X
CHLOROTOLUENE	X	X	X	X			C	X	X	X	X	E
CHLOROXY	X	X	C	G			E	C	C	C	X	E
CHROME PLATING SOLUTIONS	X	X	C	C			E	X	X	X	X	E
CHROMIC ACID	C	X	C	C	E	E	E	X	X	E	C	E
CHROMIUM TRIOXIDE	X	X	G	C			E	X	X	E	X	C
CINNAMENE	X	X	X	X			X	C	X	X	C	G
CIS-9-OCTADECENOIC ACID	X	X	X	C	E	E	E	G	C	C	C	E
CITRIC ACID	E	E	E	E	E	E	E	E	E	E	E	E
COAL TAR OIL	X	X	X	X	E	E	E	E	G	F	F	E
COAL TAR	X	X	X	X	E	E	C	C	C	C	C	E
COAL TAR NAPHTHA	X		X	X	E	E	E	X	X	X	G	E
COCONUT OIL	X	X	C	C	E	E	C	E	C	C	C	E
COKE OVEN GAS	C	X	C	X	E	E	C	X	X	C	X	E
COOLANOL	X	X	X	X			E	E	C	C	X	E
COPPER CHLORIDE	E	E	E	E	E	E	E	E	C	C	E	E
COPPER CYANIDE	E	E	E	E	E	E	G	E	E	E	E	E
COPPER HYDRATE	F		E					G		G		F
COPPER HYDROXIDE	F		E					G		G		F
COPPER SULFATE	C	G	C	E	E	E	E	E	E	E	C	E
CORN OIL	X	X	C	C	E	E	E	E	C	C	E	E
COTTONSEED OIL	X	X	C	C	E	E	C	E	C	C	E	E
CREOSOTE	X	X	X	X	E	E	C	C	C	X	C	E
CRESOLS	X	X	X	X	E	E	E	X	X	X	X	E
CRESYLIC ACID	X	X	X	X	E	E	C	X	X	X	X	E
CROTONALDEHYDE	X	F	E	E	E	E		X	X	X	X	X
CRUDE OIL	X	X	X	X	E	E	C	C	C	C	E	E
CUMENE	X	X	X	X			C	X	X	X	X	E

Blank = No data E = Excellent G = Good F = Fair C = Conditional X = Unsatisfactory

Chemical or material conveyed	Compound											
	NR	SBR	IIR	EPDM	XLPE	UPE	PTFE	NBR	CR	CSM	AU	FKM
CUPRIC CARBONATE												E
CUPRIC HYDROXIDE	F		E					G		G		F
CUPRIC NITRATE	G		E	C	E	E	G	C	E	E	G	E
CUPRIC SULFATE	C	G	C	E	E	E	E	E	E	E	C	E
CUTTING OIL	C	X	X	X			C	E	C	C	E	E
CYCLOHEXANE	X	X	X	X	E	E	C	E	X	C	C	E
CYCLOHEXANOL	C	X	X	X	E	E	C	G	C	C	F	E
CYCLOHEXANONE	X	X	C	C	E	E	C	X	X	X	X	X
CYCLOPENTANE	X		X	X			C	G	C	X	E	E
CYCLOPENTANOL												G
CYCLOPENTANONE	X		X					X		X		X
CYCLOPENTYL ALCOHOL				C				X	F			
D-FURALDEHYDE	X		C	E			C	G	F	C	C	
DOT IN KEROSENE	X	X	X	X			X	E	C	C	G	E
DECAHYDRONAPHTHALENE	X	E	X	X	E	E	C	X	X	X	X	X
DECALIN	X	E	X	X	E	E	C	X	X	X	X	X
DECYL ALCOHOL	X		X	X				E	X	C	E	G
DECYL ALDEHYDE	X		F	X				X		X		X
DECYL BUTYL PHTHALATE	X		E					X		X		F
DETERGENT, WATER SOLUTION	E	G	E	E	E	E	E	E	C	C	G	E
DEVELOPING FLUID	E	G	C	C			E	E	E	E	E	E
DEXTRON	X	X	X	X			E	E	C	X	C	E
DI (2ETHYLHEXYL) ADIPATE	X		E	G	G	G		X	X	X		F
DI (2ETHYLHEXYL) PHTHALATE	X	X	C	C	E	E	C	X	X	X	C	G
DI-ISO-BUTYLENE	X	X	X	X	E		C	C	C	X	X	E
DI-ISO-DECYL PHTHALATE	X		E	E				X	X	X		F
DI-ISO-PROPANOLAMINE	G		E	E				G	G	F		
DI-ISO-PROPYL ETHER	X		X	X	E	E	X	G	C	C	G	X
DI-ISO-PROPYL KETONE	X	X	E	E	E		C	X	X	X	X	X
DI-P-MENTHA-1,8-DIENE	X		X	X				C	X	X		E
DIACETONE ALCOHOL	X	X	E	E	E	E	X	X	F	G	X	X
DIACETYLMETHANE		X	E	E			X	X	X	X	F	X
DIAMMONIUM ORTHOPHOSPHATE				E				E	E			
DIAMYL NAPHTHALENE	X		E		E	E				X		
DIAMYLAMINE	G	X	E	E			E	G	C	C	E	X
DIAMYLENE	X		X	X					X	X		E
DIAMYLPHENOL	X		X		E	E		X		X		E
DIBENZYL ETHER	X	X	C	C			C	X	X	X	C	X
DIBROMOBENZENE	X		X	X				X	X	X		E
DIBROMOMETHANE	X		X	C			G	X	X	X	C	E
DIBUTYL ETHER	X	X	C	C	E	E	X	X	C	X	C	X
DIBUTYL PHTHALATE	X	X	C	C	E	E	C	X	X	X	C	C
DIBUTYL SEBACATE	X	X	C	C	E	E	C	X	X	X	X	E
DIBUTYLAMINE	X	X	X	F				C	X	C	C	X
DICALCIUM PHOSPHATE	E		E	E				E	E	E		E
DICHLOROETHYLENE	X		C	C	F	F	C	X	X	X	X	E
DICHLOROACETIC ACID	X	X	C	X	E	E		X	X	X	G	X
DICHLOROBENZENE	X	X	X	X			X	X	X	X	X	E
DICHLOROBUTANE	X	X	X	X			C	C	X	X	X	E
DICHLORODIFLUOROMETHANE	C	E	C	C	E	G	X	C	C	C	C	G
DICHLOROETHANE	X	X	C	X	E	E	C	X	X	X	X	E
DICHLOROETHYL ETHER	X		X	X			E	X	X	X		
DICHLOROHXANE	X		X	X				X	X	X		E
DICHLOROMETHANE	X	X	X	X			C	X	X	X	X	G
DICHLOROPENTANE	X	X	X	X				X	X	X	X	E
DICHLOROPROPANE	X		X	X	G	G		F	X	X	C	E
DICHLOROPROPENE	X		X	X	G	G		C	X	X	C	
DIESEL OIL	X	X	X	X	E	E	E	E	C	C	C	E
DIETHANOL AMINE	G	X	E	G			E	C	G	F	C	X
DIETHYLBENZENE	X	X	X				C			X	X	E
DIETHYL ETHER	X	X	X	X	E	E	X	X	X	X	C	X
DIETHYL KETONE	X		G	G	E	E		X	X	X		X
DIETHYL OXALATE	F		X	X				X	X	X		
DIETHYL PHTHALATE	X		X	F	E	E		X	X	X	C	F
DIETHYL SEBACATE	X	X	G	F			C	C	X	F	X	G
DIETHYL SULFATE	X	E	C	E			C	X	E	X	X	X
DIETHYL AMINE	C	G	C	C	E	E	C	C	C	C	C	X

Blank = No data E = Excellent G = Good F = Fair C = Conditional X = Unsatisfactory

Chemical or material conveyed	Compound											
	NR	SBR	IR	EPDM	XLPE	UPE	PTFE	NBR	CR	CSM	AU	FKM
DIETHYLENE GLYCOL	E	E	E	E	E	E	E	E	E	E	X	E
DIETHYLENE OXIDE	X		X	E			X	X	X	X	C	X
DIETHYLENTRIAMINE	G	X	E	E			E	G	X	F		X
DIHYDROXY SUCCINIC ACID	E		G	G			E	G	G	E	E	E
DIHYDROXYDIETHYL ETHER	E		E	E	E	E	E	E	E	E	X	E
DIISOBUTYL KETONE	X	X	G	E	E	E	C	X	X	X	X	E
DISODECYL PHTHALATE	X		E	E	E	E		X	X	X		F
DISOOCTYL ADIPATE	X		E	E				X	X	X		F
DISOOCTYL PHTHALATE	X		E	G	E	E		X	X	X		F
DIMETHYL CARBINOL	E		E	E	E	E	E	C	G	E	X	E
DIMETHYL KETONE	C	F	E	E	E	E	X	X	C	X	C	X
DIMETHYL PHTHALATE	X	X	C	C	E	E	C	X	X	X	X	E
DIMETHYL SULFATE	X		G	X	E	E		X	X	X	G	X
DIMETHYL SULFIDE	X		F	X				X	X	X		
DIMETHYLAMINE	G	X	G	E	E	E		F	X	X	X	X
DIMETHYLANILINE	X	X	G	E			G	X	X	X	X	X
DIMETHYLBENZENE	X	X	X	X			X	X	X	X	C	E
DIMETHYLBUTANE	X		X				X			X	G	
DIOXANE	X	X	C	C	E	E	X	X	X	X	X	X
DIPENTENE	X	X	X	X			C	C	X	X	X	E
DIPENTYLAMINE	G	X	E	E			E	G	C	C	E	X
DIPROPYLAMINEOLAMINE												
DIPROPYLENE GLYCOL	E		E	E				E	E	E		E
DISODIUM PHOSPHATE	E		E	E				E	E	E	E	E
DIVINYL BENZENE	X	X	X	X				X	X	X	X	E
DOWTHERMIN, A AND E	X	X	X	X			C	X	X	C	X	E
DRY CLEANING FLUIDS	X	X	X	X			G	C	X	X	X	E
ETHANOIC ACID		G		C	E	E		C	C			X
ETHANOL	E	E	E	E	E	E	E	C	E	E	C	E
ETHANOLAMINE	C	X	C	E			E	C	C	C	C	X
ETHERS	X	X	X	X	E	E	X	F	X	X	C	X
ETHYL ACETATE	X	X	C	C	E	E	X	X	X	X	C	X
ETHYL ACETOACETATE	C	F	C	C			X	X	X	X	C	X
ETHYL ACETONE	X		G	G				X	X	X		X
ETHYL ACRYLATE	X	X	C	C			C	X	X	X	X	X
ETHYL ALCOHOL	E	E	E	E	E	E	E	C	E	E	C	E
ETHYL ALDEHYDE	C		E	E	E	E	C	X	X	F	F	X
ETHYL ALUMINIUM DICHLORIDE	X		X					X		X		G
ETHYL BENZENE	X	X	X	X	E	E	F	X	X	X	X	E
ETHYL BROMIDE	C	X	X	X	E	E	E	C	X	X	X	E
ETHYL BUTYL ACETATE	X		E					X		G		X
ETHYL BUTYL ALCOHOL	E		E							E		G
ETHYL CELLULOSE	C	G	C	C	E	E	E	C	C	C	C	X
ETHYL CHLORIDE	C	G	E	C	E	E	G	E	X	C	C	E
ETHYL DICHLORIDE	X	X	F	X	E	E	E	X	X	X	X	G
ETHYL ETHER	X	X	X	X	E	E	X	X	X	X	C	X
ETHYL FORMATE	X	X	C	C			E	X	C	C		E
ETHYL IODIDE	X		F	F	E	E		X	X	X		G
ETHYL OXALATE	E	X	X	E			E	X	X	X	E	E
ETHYL PHTHALATE	X		X	F	E	E		X	X	X	C	F
ETHYL SILICATE	C	G	E	E			E	E	E	C	X	E
ETHYL-N-BUTYL KETONE	X		G	G				X	X	X		X
ETHYL-1-BUTANOL	E		E	E				E	E	E		
ETHYLAMINE	C	X	C	E			E	C	C	F	X	X
ETHYLENE CHLOROHYDRIN	C	G	C	C			E	X	C	C	X	E
ETHYLENE DIAMINE	C	G	E	E	E	E	G	C	E	C	X	X
ETHYLENE DIBROMIDE	X	X	C	C	F	F	G	X	X	X	X	G
ETHYLENE DICHLORIDE	X	X	C	X	F	F	C	X	X	X	X	E
ETHYLENE GLYCOL MONOETHYL ACETATE												E
ETHYLENE GLYCOL MONOBUTYL ETHER	X	X	E	E	E	E	G	F	X	C	X	X
ETHYLENE GLYCOL MONOETHYL ETHER	X		C	C	E	E	C	C	X	X	X	X
ETHYLENE GLYCOL	E	E	E	E	E	E	E	E	E	E	C	E
ETHYLENE OXIDE	X	X	C	C	E	E	X	X	X	X	X	X
FATTY ACIDS	X	X	C	X	E	G	E	C	C	C	G	E
FERRIC BROMIDE	E		E					E		E		E
FERRIC CHLORIDE	E	E	E	E			E	E	C	C	E	E
FERRIC NITRATE	E	E	E	E			E	E	E	E	E	E

Blank = No data E = Excellent G = Good F = Fair C = Conditional X = Unsatisfactory

Chemical or material conveyed	Compound											
	NR	SBR	IIR	EPDM	XLPE	UPE	PTFE	NBR	CR	CSM	AU	FKM
FERRIC SULFATE	E	E	E	E		E	E	E	E	E	E	E
FERROUS ACETATE	X		E	G				X	X	E		X
FERROUS CHLORIDE	E		E	E		E	E	E	E	E	E	E
FERROUS SULFATE	E	E	E	E		E	E	E	E	E	E	E
FLUOROBORIC ACID	E	E	C	E	E	E		E	E	E	X	E
FLUORINE	X		X	E	G	G		X	X	X	X	E
FLUOROSILICIC ACID	E	G	E	E	E	E	E	E	E	E	C	E
FORMALDEHYDE	C	G	C	C	E	E	C	C	C	C	C	E
FORMALIN	C	G	C	E	E	E	C	G	G	C	C	E
FORMIC ACID	C	E	E	E	E	E	C	C	C	E	X	C
FREON 113	G	G	X	X			X	E	E	C	C	E
FREON 12	X	E	X	C	F	G	X	C	C	E	E	E
FREON 22	C	E	C	C	F	E	X	X	E	E	X	X
FUEL A	X		X	X			F	E	C	C	E	
FUEL B	X		X	X			X	C	X	X	C	
FUEL OIL	X	X	X	X	E	E	C	E	C	C	C	E
FURAN	X	X	X	X	E	E	C	X	X	X	X	X
FURFURAL	X	X	C	C	E	E	C	X	X	C	C	X
FUEL A (ASTM)	X	X	X	X				E	C	X		E
FUEL B (ASTM)	X	X	X	X				C	X	X		E
FUEL OIL	X	X	X	X	E	E	E	E	C	C	X	E
FURAN	X	X	X	X	E	E		X	X	X		
FURFURAL	X	X	E	C	E	E	E	X	X	X		X
FURFURAN	X	X	X	X	E	E	C	X	X	X	X	X
FURFURYL ALCOHOL	X	X	C	C	E	E	G	X	X	X	X	X
GALLIC ACID	E	G	C	C	E	E	E	C	C	C	X	E
GALLOTANNIC ACID	E		G	E			E		E	E	E	E
GAS, COAL												G
GASOLINE	C	X	C	X	E	E	C	E	X	C	C	E
GLACIAL ACRYLIC ACID	X		X	X			X	X	X	G	C	
GLUCONIC ACID	X		F	E				C	E	G		
GLUCOSE	E	E	E	E	E	E	E	E	C	E	E	E
GLYCERINE	E	E	E	E	E	E	E	E	E	E	G	E
GLYCEROL	E	E	E	E	E	E	E	E	E	E	G	E
GLYCOGENIC ACID	X		F	E				F	E	G		
GLYCOLS	E	E	E	E	E	E	E	E	E	E	C	E
GLYCONIC ACID	X		F	E				F	E	G		
GLYCLYL ALCOHOL												
GREASE	X	X	X	X			G	E	F	C	E	E
GREEN SULPHATE LIQUOR	C	G	E	E			E	C	C	G	E	E
HELIUM	E	E	E	E			E	E	E	E	E	E
HEPTALDEHYDE	X	X	C	C			C	E	C	X	C	
HEPTANAL	X	X	C	C			C	E	C	X	C	
HEPTANE	X	X	X	X		E	C	E	C	C	C	E
HEPTANOIC ACID	X		X	X				E	G	C	E	
HEXADECANOIC ACID	E	G	G	G	E	E		E	X	X	E	E
HEXALDEHYDE	X	X	C	C	E	E	C	X	C	C	C	X
HEXANE	X	X	X	X	E	E	C	E	C	C	C	E
HEXANOL	E	E	C	C	E	E	E	C	C	C	C	E
HEXENE	X	X	X	X			X	C	C	C	C	E
HEXYL ALCOHOL	E	E	C	C	E	E	E	C	C	C	C	E
HEXYL METHYL KETONE	X		G	G				X	C	X	X	X
HEXYLAMINE	F		G	G				F	G	F		X
HEXYLENE GLYCOL	E		E	F				C	E	E	X	E
HISTOWAX	X		X							C	E	
HYDRAULIC & MOTOR OIL	X	X	C	C	E	E	E	C	C	C	C	E
HYDRAZINE	C	G	C	E			E	C	C	C	X	X
HYDROBROMIC ACID	E	X	E	E	E	E	E	X	C	E	X	E
HYDROCHLORIC ACID	C	X	C	C	C	C	E	C	C	C	C	E
HYDROCYANIC ACID	C	G	C	E			E	C	C	E	C	E
HYDROFLUORIC ACID	C	X	C	C	E	E	E	C	C	E	C	G
HYDROFLUOSILICIC ACID	E	G	E	E	E	E	E	X	C	E	F	E
HYDROGEN CHLORIDE ANHYDROUS	X	X	E	E			E	X	C	E		E
HYDROGEN DIOXIDE	G		G	G			E	F	F	C	G	E
HYDROGEN GAS	C	G	E	E	E	E	E	E	E	E	E	E
HYDROGEN PEROXIDE OVER 10%	C	X	C	C	C	F	C	X	X	C	C	E
HYDROGEN PEROXIDE 10%	G	X	G	G	E	E	E	F	F	C	G	E

Blank = No data E = Excellent G = Good F = Fair C = Conditional X = Unsatisfactory

Chemical or material conveyed	Compound												
	NR	SBR	IR	EPDM	XLPE	UPE	PTFE	NBR	CR	CSM	AU	FKM	
HYDROGEN SULFIDE	X	X	E	E	E	E	E	X	E	G	C	X	
HYDROXY BENZENE	C		C	C			E	X	X	C	X	E	
HYDROXYISOBUTYRONIRILE	C		E	E				C	G	F	X		
HYDROXYTOLUENE	X	X	C	C			E	X	C	C	X	E	
IMINODI-2-PROPANOL	G		E	E				G	G	F			
IMINODIETHANOL	C	X	G	G			E	C	G	F	C	X	
IODINE	X	G	C	C	E	E	E	C	C	C	C	E	
IODINE PENTAFLUORIDE	X	X	X	X			X	X	X	X	X	X	
IODIFORM	X		X	E			X	E	X	X	C		
ISO-BUTANAL	X	G		G	E	E	X	X	F		X	X	
ISO-BUTYLAMINE	F		E	G				X	X	F		X	
ISO-BUTYLBROMIDE	X		X	X				X	X	X		G	
ISO-BUTYL CARBINOL	X		E	E			E	E	E	E	F	E	
ISOCYANATES	F		G	G	E	E	F	C	X	F	G	G	
ISOOCTANE	X	X	X	X	E	E	F	E	C	C	C	E	
ISOPROPYL ACETATE	X	X	C	C	E	E	X	X	X	X	X	X	
ISOPROPYL ALCOHOL	E	E	E	E	E	E	E	C	C	E	X	E	
ISOPROPYL ETHER	X	X	X	X	E	E	X	G	X	C	G	X	
JET FUELS	X	X	X	X	E	E	C	C	C	X	C	E	
JP-4 OIL	X	X	X	X			C	E	X	X	C	E	
KEROSENE	X	X	X	X	E	E	C	E	C	C	E	E	
KETONES	C	E	G	E	E	E	X	C	C	C	C	X	
LACQUER SOLVENTS	X		X	X	E	E	X	X	X	X	X	X	
LACTIC ACID - COLD	E	G	E	C	G	G	E	C	C	E	C	E	
LACTIC ACID - HOT	E	X	E	C	G	G	E	C	C	E	C	E	
LARD	X	X	C	C	E	E	E	E	C	G	E	E	
LAVENDER OIL	X	X	X	X			E	C	X	X	X	E	
LEAD ACETATE	E	X	E	E	E	E	X	C	C	X	C	E	
LEAD NITRATE	E	E	E	E			G	E	E	E		E	
LEAD SULFATE	E		E	E	E	E		E	E	E	G	E	
LIME	E		E	E	E	E		G	G	G	E	E	
LIME BLEACH	C	E	E	E			E	C	C	E	C	E	
LIME SULFUR	C	X	E	E	E	E	E	E	E	E	C	E	
LIMONENE	X		X	X			C	C	X	X	X	E	
LINOLEIC ACID	X	X	X	X			E	C	C	X	F	G	
LINSEED OIL	X	X	C	C	E	E	E	E	C	C	E	E	
LIQUID PETROLEUM GAS	X	X	X	X	E	E	G	E	G	C	E	E	
LUBRICATING OIL	X	X	X	X	E	E	E	C	C	C	C	E	
LYE SOLUTIONS	E	G	E	G			E	C	G	E	C	G	
MEK	X	X	E	E	E	E	X	X	X	X	X	X	
MAGNESIUM ACETATE	X	X	E	G				X	X	E	X	X	
MAGNESIUM CHLORIDE	E	E	E	E	E	E	E	E	E	E	E	E	
MAGNESIUM HYDRATE	C	G	E	E	E	E	G	C	C	E	C	G	
MAGNESIUM HYDROXYDE	G	G	E	E	E	E	G	C	C	E	C	G	
MAGNESIUM SULFATE	C	G	E	E	E	E	E	E	E	E	G	E	
MALEIC ACID	X	X	X	C	E	E	E	X	X	X	C	E	
MALEIC ANHYDRIDE	X	X	C	C			E	X	X	X		G	
MALIC ACID	E	G	X	C	C	G	E	E	C	C	C	E	
MANGANOUS SULFATE	G		G	E			E	E	E	E	X		
MERCURY	E	E	E	E	E	E	E	E	E	E	E	E	
MERCURY VAPORS	G	E	E	E			E	E	G	E		E	
MESITYL OXIDE	X	X	F	C			X	X	X	X	X	X	
METHALLYL ALCOHOL	E		E	E				E	E	E		G	
METHALLYL CHLORIDE	X		X						X	X	C		
METHANE CARBOXYLIC ACID see Acetic Acid					E	E							
METHANOIC ACID	C	E	E	E	E	E	C	G	E	E	X	C	
METHANOL	E	E	C	E	E	E	E	C	E	E	C	F	
METHOXY ETHANOL	E		E	E	E	E		C	E	E	X		
METHYL ACETATE	C	X	C	C			X	X	C	X	X	X	
METHYL ACETOACETATE	X	X	C	C			X	X	X	X	X		
METHYL ACETONE	X	X	E	E	E	E	X	X	X	X	X		
METHYL ALLYL CHLORIDE	X		X						X	X	C	F	
METHYL AMYL CARBINOL	G		G	E			C	E	G	E	X	G	
METHYL BENZENE	X	X	X	X	F	F	X	X	X	X	X	E	
METHYL BROMIDE	X	X	C	X	F	F	G	C	X	X	X	E	
METHYL BUTANE	X		X	X			X	E	X	X	G		
METHYL BUTYL KETONE	X	X	E	E	E	E	X	X	X	X	X	X	

Blank = No data E = Excellent G = Good F = Fair C = Conditional X = Unsatisfactory

Chemical or material conveyed	Compound											
	NR	SBR	IR	EPDM	XLPE	UPE	PTFE	NBR	CR	CSM	AU	FKM
METHYL CARBITOL				G			E	F	F			
METHYL CELLOSOLVE	X	X	C	C	E	E	E	C	C	C	X	X
METHYL CHLORIDE	X	X	C	C	F	F	X	X	X	X	X	E
METHYL CYANIDE	G		E	E			E	C	E	G	X	X
METHYL ETHYL KETONE	X	X	E	E	E	E	X	X	X	X	X	X
METHYL HEXANOL	E		E	E				E	E	E		G
METHYL METHACRYLATE	X	X	X	X	E	E	X	X	X	X	X	X
METHYL NORMAL AMYL KETONE	X			E				C	E	X		X
METHYL PROPYL ETHER	X		X	X				X	X	C	X	
METHYL SALICYLATE	X		C	C	E	E	F	X	X	X		
METHYL STYRENE	X		X	X				X	X	X		
METHYL SULFIDE	X		F	X				X	X	X		
METHYL-ISO-AMYL-KETONE	X		G							X		
METHYL-2-BUTANONE	X	X	C	C			X	X	X	X	X	X
METHYL-2-HEXANONE	X		G							X		
METHYL-2-PENTANOL	G		E	E				G	G	E		C
METHYL-2-PENTANONE	X		C	C			X	X	X	X	X	
METHYL-4-ISOPROPYL BENZENE	X		X	X			F	X	X	X	X	E
METHYL AMYL ACETATE	X									X		X
METHYL AMYL ALCOHOL	G		E	E				G	G	E		C
METHYLCYCLOHEXANE	X		X	X				X	X	C		G
METHYLENE BROMIDE	X		X	X	E	E	G	C	X	X	C	G
METHYLENE CHLORIDE	X	X	X	C	F	F	C	X	X	X	X	G
METHYLETHYL KETONE	X	X	E	E			X	X	X	X	X	X
METHYL HEXYL KETONE	X		G	G	E			X	C	X	X	X
METHYL ISOBUTYL CARBINOL	G		E	C				X	X	E		C
METHYLISOBUTYL KETONE	X	X	C	C	E	E	X	X	X	X	X	X
METHYLISOPROPYL KETONE	X	X	C	C			X	X	X	X	X	X
METHYL LACTONITRILE	F		E	E				X	G	F	X	
METHYLPROPYL CARBINOL	E		E					E		E		G
METHYLPROPYL KETONE	X		G	G	E	E		X	X	X		X
MIL-A-6091	E		E	E				C	E	E	X	
MIL-C-4339	X		X	X				E	X	X	E	
MIL-C-7024	X		X	X				E	C	X	E	
MIL-E-9500	E	E	E	E				E	E	E	X	E
MIL-F-16884	X	X	X	X				E	C	C	C	E
MIL-F-17111	X	X	X	X				E	C	X	C	E
MIL-F-25558	X	X	X	X			E	E	C	C	G	
MIL-G-10924	X	X	X	X				E	C	C	G	E
MIL-G-25013	C	X	X	E				E	C	C	C	
MIL-G-25537	X	X	X	X				E	C	C	G	
MIL-G-3545	X		X	X				E	C	C	E	
MIL-G-5572	X	X	X	X				E	X	X	C	E
MIL-G-7711	X	X	X	X				E	X	X	E	E
MIL-H-05606	X		X	C				E	C	C	C	E
MIL-H-13910	E	E	G	E				E	E	G	X	E
MIL-H-19457	X	X	E	C				X	X	X	X	C
MIL-H-22251		G	E	E				C	C	C		
MIL-H-27601	X		X	X				G	G	C	C	X
MIL-H-5806	X		X	C			E	E	C	C	C	E
MIL-H-6083	C	X	X	X				E	E	C	G	E
MIL-H-8446	X	X	X	X			E	G	E	C	C	E
MIL-J-5161	X	X	X	X				C	X	X	C	E
MIL-J-5624	X	X	X	X			C	E	X	X	C	E
MIL-L-15016	X	X	X							C	E	E
MIL-L-17331	X	X	X							G	E	E
MIL-L-2104	X		X	X				E	C	C	E	
MIL-L-21280	X	X	X	X				E	C	C	E	
MIL-L-23699	X	X	X	X			E	C	C	C	C	
MIL-L-25681	C	G	E	E				C	C	C	C	
MIL-L-3150	X	X	X	X				E	C	C	C	E
MIL-L-4343		X										E
MIL-L-6082		X										E
MIL-L-6085	X	X	X	X				C	X	X	C	E
MIL-L-7808	X	X	X	X			E	G	X	X	X	E
MIL-L-7870	X	X	X	X				E	C	X	C	E
MIL-L-9000	X	X	X	X				E	C	C	C	E

Blank = No data E = Excellent G = Good F = Fair C = Conditional X = Unsatisfactory

Chemical or material conveyed	Compound											
	NR	SBR	IR	EPDM	XLPE	UPE	PTFE	NBR	CR	CSM	AU	FKM
MIL-L-9236	X	X	X	X				C	X	X	X	E
MIL-P-27402		G	E	E				C	C	C		
MIL-R-25576	X		X				E			C	E	
MIL-S-3136 TYPE 1 FUEL	X	X	X	X				E	C	C	G	E
MIL-S-3136 TYPE 2 FUEL	X	X	X	X				C	X	X	C	E
MIL-S-3136 TYPE 3 FUEL	X	X	X	X				G	X	X	C	E
MIL-S-3136 TYPE 4 OIL, LOWSWELL	X	X	X	X				E	X	C	E	E
MIL-S-3136 TYPE 5 OIL, MEDSWELL	X	X	X	X				E	G	G	E	E
MIL-S-3136 TYPE 6 OIL, HI SWELL	X	X	X	X			E	E	X	C	E	E
MIL-S-81087	E	E	E	E				E	E	E	E	
MINERAL OIL	X	X	C	X	E	E	E	E	C	C	E	E
MINERAL SPIRITS	X	X	X	X				C	C	G	C	E
MOBILE HF A	X	X	X	X			E	E	C	X	G	E
MOLTEN SULFUR	G		G	E				G	E	E	G	E
MONO-CHLOROACETIC ACID	C	X	G	G	E	E	X	X	C	G	X	C
MONOBUTYL ETHER	X	X	C	C				G	C	C	C	X
MONOCHLOROBENZENE	X	X	X	X	F	F	C	X	X	X	X	E
MONOCHLORODIFLUOROMETHANE	C	E	C	C	E	E	X	X	C	E	X	C
MONOETHANOL AMINE	C	G	C	C			E	G	G	C	C	X
MONOETHYL AMINE	C	F	C	E			E	C	C	F	X	X
MORPHOLINE	X		C	C				X	X	X	C	
MOTOR OIL, 40W	X		X	X				E	C	C	G	E
MTBE			G				G	X	X			
MURIATIC ACID	C	X	C	F				C	C	C	C	E
N-BUTANAL	X	X	C	C	E	E	X	X	X	X	C	X
N-BUTYLAMINE	X	X	C	C			C	C	X	X	X	X
N-BUTYLBENZENE	X		X	X				X	X	X		E
N-BUTYLBROMIDE	X		X	X				X	X	X		G
N-BUTYLBUTYRATE	X	X	E	E			E	X	X	X		E
N-BUTYL CARBINOL	E		E	E	E	E	E	E	E	E	X	G
N-NONYL ALCOHOL	E		E	E				E	E	E		G
N-OCTANE	X	X	X	X	E	E	C	C	G	X	X	E
NAPHTHA	X	X	X	X	E	E	E	C	X	C	F	E
NAPHTHALENE	X	X	X	X	E	E	F	X	X	X	C	E
NAPHTHENIC ACID	X	X	X	X			E	C	X	X		E
NATURAL GAS	C	F	X	X	E	E	E	E	E	E	F	E
NEOHXANE	X		X	X				E	G	X	X	E
NEON GAS	E	E	E	E			E	E	E	E	E	E
NEU-TRI	X		X					X		X		E
NICKEL ACETATE	E	X	E	E			X	C	G	X	X	X
NICKEL CHLORIDE	E	E	E	E	E	E	E	E	C	E	C	E
NICKEL NITRATE	E		E	E	E	E		E	E	E	C	E
NICKEL SULFATE	C	G	E	E	E	E	E	E	E	E	E	E
NITRIC ACID, CONC	X		X	X			C	X	X	X	X	
NITRIC ACID, RED FUMING	X	X	X	X	X	X	F	X	X	X	X	E
NITRIC ACID, 10%	X	X	E	E	E	E	E	X	G	E	X	E
NITRIC ACID, 13N	X						C	X	X		X	
NITRIC ACID, 13N +5%	X						C	X	X		X	
NITRIC ACID, 20%	X	X	G	E	E	E	E	X	X	E	X	E
NITRIC ACID, 30%	X	X	F	F	G	G	E	X	X	E	X	E
NITRIC ACID, 30% - 70%	X	X	F	X	F	F	G	X	X	C	X	E
NITRILOTRIETHANOL	C	G	E	E	E	E	E	F	C	C	X	X
NITROBENZENE	X	X	F	C	E	E	E	X	X	X	X	G
NITROETHANE	G	G	G	C			C	X	C	G	X	X
NITROGEN	E	E	E	E	E	E	E	E	E	E	E	E
NITROMETHANE	G	C	G	C			C	X	C	C	X	X
NITROUS OXIDE GAS				E			F	E	G			E
NONANOIC ACID	X		E		E	E		E		X		
NONANOL	E		E	E				E	E	E		
OCTANOIC ACID	F		F				G	F		G		
OCTANOL	C	E	C	C			E	C	C	C	X	E
OCTYL ACETATE	C	X	E	G	E	E		C	C	E	X	
OCTYL ALCOHOL	C	E	C	C			E	C	C	C	X	G
OCTYL ALDEHYDE	X		F		E	E		X		X		X
OCTYL AMINE	F		E	G				F	G	F		X
OCTYL CARBINOL	E		E	E				E	E	E		G
OCTYLENE GLYCOL	E		E	E				E	E	E		E

Blank = No data E = Excellent G = Good F = Fair C = Conditional X = Unsatisfactory

Chemical or material conveyed	Compound											
	NR	SBR	IIR	EPDM	XLPE	UPE	PTFE	NBR	CR	CSM	AU	FKM
POTASSIUM PERMANGANATE, 5%	E	G	E	E	E	E	E	F	E	G	X	E
POTASSIUM SILICATE	E	E	E	E	E	E	E	E	E	E	E	E
POTASSIUM SULFATE	C	G	E	E	E	E	E	E	E	E	E	E
POTASSIUM SULFIDE	G	G	E	E	E	E	E	C	E	E	C	E
POTASSIUM SULFITE	C	G	E	E	E	E	E	E	E	C	E	E
PRESTONE ANTIFREEZE	E	E	E	E	E	E	G	E	E	E	X	E
PRODUCER GAS	X	X	X	X	E	E	E	E	G	C	E	E
PROPANE	X	X	X	X	E	E	E	E	E	G	G	E
PROPANEDIOL	E	E	E	E	E	E	E	E	G	E	G	E
PROPANETRIOL	E	E	E	E	E	E	E	E	E	E	C	E
PROPANOL	E	E	E	E	E	E	E	E	E	E	X	E
PROPANOLAMINE												
PROPANONE	C	G	E	E	E	E	X	X	X	C	X	X
PROPENOL	E		E							E		E
PROPANEDIAMINE	G		E					G		F		
PROPENE NITRILE	G		X		E	E		X	X			
PROPENYL ALCOHOL	E		E	E	E	E		E	E	E		E
PROPENYL ANISOLE	X		X		E	E		X		X		G
PROPIONIC ACID	E	X	E	E			E	C	C	G	X	X
PROPIONITRILE	E		E	C			E	E	C			X
PROPYL ACETATE	X	X	C	C	E	E	X	X	X	X	X	X
PROPYL ALCOHOL	E	E	E	E	E	E	E	E	E	E	X	E
PROPYL ALDEHYDE	F		G	G				X	X	X		X
PROPYL BENZENE	X		X						X	X	C	
PROPYL CHLORIDE	X		F	F				X	F	X		G
PROPYL NITRATE	X	X	C	C			F	X	X	X	X	X
PROPYLENE	X	X	X	X			E	X	X	X	X	E
PROPYLENE DIAMINE	G		E					G		F		
PROPYLENE GLYCOL	E	E	E	E	E	E	E	E	E	E	G	E
PYDRAUL, 'E' SERIES	X	X	C	G			E	X	X	X	X	X
PYDRAULIC 'C'	X	X	X	X			E	X	X	X	X	E
RED OIL	X	X	X	F	E	E	E	E	F	C	C	E
REFRIGERANT 11	X	X	X		E	E	X			E	X	C
REFRIGERANT 12	X	E	X		E	E	X			E	E	G
REFRIGERANT 22	C	E	X		E	E	X			E	X	C
RESORCINOL	E	G	E	G			E	C	A	G	X	E
SAE NO. 10 OIL	X	X	X	X			E	E	C	X	E	E
SAL AMMONIAC	E	E	E	E	E	E	E	E	E	E	G	E
SEA WATER	E	E	E	E	E	E	E	E	E	E	G	E
SEWAGE	G	G	G	G	E	E	E	E	C	E	X	E
SILICATE ESTERS	X	C	X	X			E	G	E	G	E	E
SILICATE OF SCDA	E	E	E	E			E	E	E	E	G	E
SILICONE GREASE	E	E	E	E	E	E	E	E	E	E	E	E
SILICONE OIL	E	E	E	E	E	E	E	E	E	E	E	E
SILVER NITRATE	E	G	E	E	E	E	E	C	E	E	E	E
SKYDROL 500 TYPE 2	X	X	G	E			X	X	X	X	X	G
SKYDROL 500B	X	X	G	E			X	X	X	X	X	G
SKYDROL 500C	X	X	G	E			X	X	X	X	X	G
SKYDROL 7000 TYPE 2	E	X	E	E			E	X	X	X	X	F
SOAP SOLUTIONS	F	X	E	E	E	E	E	E	G	E	G	E
SODA ASH	E	X	E	E	E	E	E	E	E	E	G	E
SODA LIME	E		E	E			G	G	G	G	F	G
SODA NITER	G	G	E	E	E	E	E	E	G	E	E	E
SODIUM ACETATE	F	X	F	E	E	E	C	G	C	G	C	X
SODIUM ALUMINATE	E	G	E	E			E	E	E	E	X	E
SODIUM BICARBONATE	E	E	E	E	E	E	E	E	E	E	E	E
SODIUM BISULFATE	E	G	E	E	E	E	E	E	E	E	E	E
SODIUM BISULFITE	E	G	E	E	E	E	E	E	E	E	G	E
SODIUM BORATE	E	E	E	E	E	E	E	E	E	E	E	E
SODIUM CARBONATE	E	E	E	E	E	E	E	E	E	E	C	E
SODIUM CHLORIDE	E	E	E	E	E	E	E	E	E	E	E	E
SODIUM CYANIDE	E	E	E	E	E	E	E	E	E	E	E	E
SODIUM DICHROMATE	X	G	E	E			E	E	F	G	G	E
SODIUM HYDRATE	E	G	E	E	E	E	E	X	G	C	C	G
SODIUM HYDROCHLORITE	F	G	G	G			E	F	F	E	C	E
SODIUM HYDROXIDE	E	G	E	E	E	E	E	X	G	C	C	G
SODIUM HYPOCHLORITE	X	F	C	E	E	E	E	C	C	G	X	E

Blank = No data E = Excellent G = Good F = Fair C = Conditional X = Unsatisfactory

Chemical or material conveyed	Compound											
	NR	SBR	IIR	EPDM	XLPE	UPE	PTFE	NBR	CR	CSM	AU	FKM
POTASSIUM PERMANGANATE, 5%	E	G	E	E	E	E	E	F	E	G	X	E
POTASSIUM SILICATE	E	E	E	E	E	E	E	E	E	E	E	E
POTASSIUM SULFATE	C	G	E	E	E	E	E	E	E	E	E	E
POTASSIUM SULFIDE	G	G	E	E	E	E	E	C	E	E	C	E
POTASSIUM SULFITE	G	G	E	E	E	E	E	E	E	C	E	E
PRESTONE ANTIFREEZE	E	E	E	E	E	E	G	E	E	E	X	E
PRODUCER GAS	X	X	X	X	E	E	E	E	G	C	E	E
PROPANE	X	X	X	X	E	E	E	E	E	C	G	E
PROPANEDIOL	E	E	E	E	E	E	E	E	G	E	G	E
PROPANETRIOL	E	E	E	E	E	E	E	E	E	E	C	E
PROPANOL	E	E	E	E	E	E	E	E	E	E	X	E
PROPANOLAMINE												
PROPANONE	C	G	E	E	E	E	X	X	X	C	X	X
PROPENOL	E		E							E		E
PROPANEDIAMINE	G		E					G		F		
PROPENE NITRILE	G		X		E	E		X	X			
PROPENYL ALCOHOL	E		E	E	E	E		E	E	E		E
PROPENYL ANISOLE	X		X		E	E		X		X		G
PROPIONIC ACID	E	X	E	E			E	C	C	G	X	X
PROPIONITRILE	E		E	C			E	E	C			X
PROPYL ACETATE	X	X	C	C	E	E	X	X	X	X	X	X
PROPYL ALCOHOL	E	E	E	E	E	E	E	E	E	E	X	E
PROPYL ALDEHYDE	F		G	G				X	X	X		X
PROPYL BENZENE	X		X						X	X	C	
PROPYL CHLORIDE	X		F	F				X	F	X		G
PROPYL NITRATE	X	X	C	C			F	X	X	X	X	X
PROPYLENE	X	X	X	X			E	X	X	X	X	E
PROPYLENE DIAMINE	G		E					G		F		
PROPYLENE GLYCOL	E	E	E	E	E	E	E	E	E	E	G	E
PYDRAULIC 'E' SERIES	X	X	C	C			E	X	X	X	X	X
PYDRAULIC 'C'	X	X	X	X			E	X	X	X	X	E
RED OIL	X	X	X	F	E	E	E	E	F	C	C	E
REFRIGERANT 11	X	X	X		E	E	X			E	X	C
REFRIGERANT 12	X	E	X		E	E	X			E	E	G
REFRIGERANT 22	C	E	X		E	E	X			E	X	C
RESORCINOL	E	G	E	G			E	C	A	G	X	E
SAE NO. 10 OIL	X	X	X	X			E	E	C	X	E	E
SAL AMMONIAC	E	E	E	E	E	E	E	E	E	E	G	E
SEA WATER	E	E	E	E	E	E	E	E	E	E	G	E
SEWAGE	G	G	G	G	E	E	E	E	C	E	X	E
SILICATE ESTERS	X	C	X	X			E	G	E	G	E	E
SILICATE OF SODA	E	E	E	E			E	E	E	E	G	E
SILICONE GREASE	E	E	E	E	E	E	E	E	E	E	E	E
SILICONE OIL	E	E	E	E	E	E	E	E	E	E	E	E
SILVER NITRATE	E	G	E	E	E	E	E	C	E	E	E	E
SKYDROL 500 TYPE 2	X	X	G	E			X	X	X	X	X	G
SKYDROL 500B	X	X	G	E			X	X	X	X	X	G
SKYDROL 500C	X	X	G	E			X	X	X	X	X	G
SKYDROL 7000 TYPE 2	E	X	E	E			E	X	X	X	X	F
SOAP SOLUTIONS	F	X	E	E	E	E	E	E	G	E	G	E
SODA ASH	E	X	E	E	E	E	E	E	E	E	G	E
SODA LIME	E		E	E			G	G	G	G	F	G
SODA NITER	G	G	E	E	E	E	E	E	G	E	E	E
SODIUM ACETATE	F	X	F	E	E	E	C	G	C	G	C	X
SODIUM ALUMINATE	E	G	E	E			E	E	E	E	X	E
SODIUM BICARBONATE	E	E	E	E	E	E	E	E	E	E	E	E
SODIUM BISULFATE	E	G	E	E	E	E	E	E	E	E	E	E
SODIUM BISULFITE	E	G	E	E	E	E	E	E	E	E	G	E
SODIUM BORATE	E	E	E	E	E	E	E	E	E	E	E	E
SODIUM CARBONATE	E	E	E	E	E	E	E	E	E	E	C	E
SODIUM CHLORIDE	E	E	E	E	E	E	E	E	E	E	E	E
SODIUM CYANIDE	E	E	E	E	E	E	E	E	E	E	E	E
SODIUM DICHROMATE	X	G	E	E			E	E	F	G	G	E
SODIUM HYDRATE	E	G	E	E	E	E	E	X	G	C	C	G
SODIUM HYDROCHLORITE	F	G	G	G			E	F	F	E	C	E
SODIUM HYDROXIDE	E	G	E	E	E	E	E	X	G	C	C	G
SODIUM HYPOCHLORITE	X	F	C	E	E	E	E	C	C	G	X	E

Blank = No data E = Excellent G = Good F = Fair C = Conditional X = Unsatisfactory

Chemical or material conveyed	Compound											
	NR	SBR	IR	EPDM	XLPE	UPE	PTFE	NBR	CR	CSM	AU	FKM
SODIUM METAPHOSPHATE	E	E	G	E	E	E	E	E	E	C	C	E
SODIUM NITRATE	G	G	E	E	E	E	C	C	G	E	E	E
SODIUM PERBORATE	G	G	E	E			E	C	G	E	G	E
SODIUM PEROXIDE	C	G	E	E	E	E	E	C	G	G	X	E
SODIUM PHOSPHATE	E	E	E	E	E	E	E	E	G	E	E	E
SODIUM SILICATE	E	E	E	E	E	E	E	E	E	E	G	E
SODIUM SULFATE	C	G	E	E	E	E	E	E	E	E	E	E
SODIUM SULFIDE	G	G	E	E	E	E	E	E	E	E	E	E
SODIUM SULFITE	G	G	E	E	E	E	E	E	E	E	E	E
SODIUM THIOSULFATE	G		E	E	E	E	E	C	E	E	E	E
SOYBEAN OIL	X	X	G	C			E	E	E	G	C	E
STANNIC CHLORIDE	E	E	E	E	E	E	E	E	G	E	E	E
STANNIC SULFIDE	E		E	E				E	E	E		
STANNOUS CHLORIDE	E	E	E	G	E	E	E	E	E	E	G	E
STANNOUS SULFIDE	E		E	E				E	E	E		
STEAM, BELOW 350 DEG F	C	X	G	E	X	X	E	X	X	C	X	C
STEARIC ACID	C	G	C	G	E	E	E	G	G	G	E	E
STODDARD SOLVENT	X	X	X	X	E	E	G	E	G	X	E	E
STYRENE	X	X	X	X	F	F	X	X	X	X	X	E
SULFAMIC ACID	G		E	E				C	G	E	X	E
SULFUR	X	X	E	E	E	E	E	X	E	E	X	E
SULFUR CHLORIDE	X	X	X	E			E	C	E		C	E
SULFUR DIOXIDE	C	G	C	E		G	G	X	C	C	C	E
SULFUR TRIOXIDE, DRY	C	X	G	E	X	X	G	X	X	X	X	E
SULFURIC ACID, CONC.	X	X	X	X	F	F	E	X	X	X	X	E
SULFURIC ACID, FUMING	X	X	X	X	X	X	E	X	X	X	X	E
SULFURIC ACID, 25%	E	F	G	E	E	E	E	C	C	E	X	E
SULFURIC ACID, 25%-50%	G	F	G	E	E	E	E	C	X	G	X	E
SULFURIC ACID, 50%-88%	X	X	X	X	G	G	E	X	X	X	X	E
SULFUROUS ACID, 10%	G	G	E	E	E	E	E	E	C	E	X	E
SULFUROUS ACID, 10%-75%	G	G	E	E	E	E	E	F	C	E	X	E
T-BUTYL AMINE	X		C	C			G	C	X	X	X	
TALL OIL	X	X	X	X			E	E	G	F	E	E
TALLOW	X	X	X	E	E	E	E	E	G	F	E	E
TANNIC ACID	E	G	E	E	E	E	E	E	E	E	E	E
TAR	X	X	X	X	X	F	E	X	X		G	E
TAR BITUMINOUS	X	X	X	X			E	G	C	X	G	E
TARTARIC ACID	E	G	G	G	E	E	E	E	E	E	E	E
TELLONE 2	C											
TERTIARY BUTYL ALCOHOL	C	G	C	C			E	C	C	C	X	E
TERPINEOL	X	X	C				E			X	C	E
TERTIARY BUTYL AMINE	X		C	C			G	C	X	X	X	
TERTIARY BUTYL MERCAPTAN	X	X	X	X			E	X	X	X	X	E
TETRACHLOROBENZENE	X		X	X				X	X	X		G
TETRACHLOROETHANE	X	X	X	X	F	F	X	X	X	X	X	E
TETRACHLOROETHYLENE	X	X	X	X	F	F	X	C	X	X	X	E
TETRACHLOROMETHANE	X		X	X	E	E	E	X	X	X	F	E
TETRACHLORONAPHTHALENE	X		X	X	E	E		X	X	X		G
TETRAETHYLENE GLYCOL	E		E	E				E	E	E		E
TETRAETHYLORTHOSILICATE	X		E	E				E	E			
TETRAHYDROFURAN	X	X	C	X			X	X	X	X	X	X
TIN CHLORIDE	E		E	E	E	E	E	E	C	C	G	E
TITANIUM TETRACHLORIDE	X	X	X	X			G	C	C	X	X	E
TOLUENE	X	X	X	X	E	E	X	X	X	X	X	E
TOLUIDINE	X		X	X	E	F		C	X	X	C	G
TOLUOL	X	X	X	X	E	E	X	X	X	X	X	E
TRANSFORMER OIL	X	X	X	X	E	E	E	C	C	C	C	E
TRANSMISSION 'W' OIL	X		X	X			E	E	C	C	E	
TRI-AMINE	C		E	E			E	G	C	C	X	
TRIBUTYL PHOSPHATE	C	X	G	G			G	F		X	X	X
TRIBUTYLAMINE	G		E					G		F		
TRICHLOROACETIC ACID	C	X	C	C			F	C	C	X	X	X
TRICHLOROENZENE	X	X	X	X	F	F	C	C	X	X	C	G
TRICHLOROETHANE	X	X	X	X			X	X	X	X	X	E
TRICHLOROETHYLENE	X	X	X	X	F	F	X	X	X	X	X	E
TRICHLOROMETHANE	X	X	X	X	F	F	X	X	X	X	X	E
TRICHLOROTOLUENE	X		E				E	X	X	X		

Blank = No data E = Excellent G = Good F = Fair C = Conditional X = Unsatisfactory

Chemical or material conveyed	Compound											
	NR	SBR	IR	EPDM	XLPE	UPE	PTFE	NBR	CR	CSM	AU	FKM
TRICRESYL PHOSPHATE	X	X	E	E			E	X	X	X	X	E
TRITHANOLAMINE	C	G	E	E	E	E	E	C	C	C	X	X
TRIETHYLAMINE	G	X	G	E			E	E	G	E	X	E
TRIETHYLENE GLYCOL	E		E	E	E	E		C	E	E	X	E
TRIHYDROXYBENZOIC ACID	E		C	C			E	C	C	G	X	
TRIMETHYL PENTANE	X	X	X	X			F	E	G	G	G	E
TRIMETHYLAMINE	E		E	C				C	E	E	X	
TRISODIUM PHOSPHATE	E	E	E	E	E	E	E	E	E	E	E	E
TRITOYL PHOSPHATE	X	X	E	E			E	X	C	C	C	E
TUNG OIL	X	X	C	X	E	E	E	E	C	C	F	E
TUNG OIL	X	X	C	X	E	E	E	E	C	C	F	E
TURPENTINE	X	X	X	X	E	E	E	E	X	X	G	E
UNSYMMETRICAL DIMETHYL HYDRAZINE	E	X	E	E			F	C	C	E	X	X
UNDECYL ALCOHOL	E		E	E				E	E	E		G
UREA	E		E	E	E	E	F	G	G	E	G	E
URIC ACID	E		E	E				C	E	E	X	
VARNISH	X	X	X	X	E	E	C	G	X	X	G	E
VEGETABLE OILS	X	X	C	F	E	E	E	E	C	G	E	E
VERSILUBE F44	E	E	E	E			E	E	E	E	E	E
VERSILUBE F55	E	E	E	X			E	E	E	E	E	E
VINEGAR	G	G	E	E	E	E	E	G	G	E	C	E
VINEGAR ACID	G		E		E	E	E			E	C	
VINYL ACETATE	X	X	E	G	E	E	X	C	C	F	X	E
VINYL BENZENE	X	X	X	X	F	F	X	C	X	X	C	G
VINYL CHLORIDE	X		X	C	E	E	E	X	X	X	C	E
VINYL CYANIDE	G	F	X	X	E	E	G	X	X	G	X	X
VINYL ETHER	X		X				X	G		G		X
VINYL STYRENE												
VINYL TOLUENE	X		X	X				X	X	X		E
VINYL TRICHLORIDE	X		X	X			X	X	X	X	X	E
VM & NAPHTHA	X	X	X	X				G	F	X		E
WATER	E	C	E	E	E	E	E	E	G	E	E	E
WATER, BOILING	E		E	E			E	G	G	E	E	
WATER, SODA					E	E						
WEMCO C	X	X	X	X			E	E	C	X	E	E
WHISKEY	E	E	E	E	E	E	E	E	E	E	X	E
WHITE OIL	X	X	X	X	E	E	E	E	G	C	E	E
WHITE PINE OIL	X	X	X	X			E	G	X	X		E
WINES	E	E	E	E	E	E	E	E	E	E	X	E
WOOD ALCOHOL	E	E	C	E	E	E	E	C	E	E	C	F
WOOD OIL	X	X	C	X	E	E	E	E	C	C	C	E
XENON	E	E	E	E			E	E	E	E	E	E
XYLENE, XYLON	X	X	X	X	F	F	X	X	X	X	X	E
XYLIDINE	X	X	G	G			G	C	X	X	X	X
ZEOLITES	E	E	E	E			E	E	E	E	E	E
ZINC ACETATE	E	X	E	E			F	G	C		X	C
ZINC CARBONATE	E		E	E				E	E	E	E	E
ZINC CHLORIDE	E	E	E	E	E	E	E	E	E	E	E	E
ZINC CHROMATE	E		E	E				C	E	G	X	
ZINC SULFATE	E	G	E	E	E	E	E	E	E	E	X	E
O-AMINOTOLLENE	X		C	C			C	X	X	X	X	
1 UNDECANOL	E	E	E	E	E	G		E	E	E		G
1-AMINO-2-PROPANOL	G		E	E				C	E	F		X
1-AMINO BUTANE	X	X	C	C			G	C	X	X	X	X
1-AMINOPENTANE	F		G	X				F	C	F		X
1-BROMO-2-METHYL PROPANE	X		X	X				X	X	X		G
1-BROMO-3-METHYL BUTANE	X		X	X				X	X	X		G
1-BROMOBUTANE	X		X	X				X	X	X		
1-CHLORO-2-METHYL PROPANE	X		X	X				X	X	X		G
1-CHLORO-3-METHYL BUTANE	X		X	X			X	X	X	X	X	E
1-DECANOL	X		X	X	E	E		E	X	C	E	G
1-HENDECANOL	E		E	E				E	E	E		
1,4-DIOXANE	X		C	C	E		X	X	X	X	X	
2,2AMINOETHYLAMINO) ETHANOL	G		E							G		
2,2ETHOXYETHOXY) ETHANOL	C	G	C	C			E	C	C	C	X	G
2,2ETHOXYETHOXY) ETHYL ACETATE	X	X	G	X			E	X	X	G	X	G
2-AMINOETHANOL	C	F	C	E			E	C	C	C	X	X

Blank = No data E = Excellent G = Good F = Fair C = Conditional X = Unsatisfactory

Chemical or material conveyed	Compound											
	NR	SBR	IIR	EPDM	XLPE	UPE	PTFE	NBR	CR	CSM	AU	FKM
2-CHLORO-1-HYDROXY-BENZENE	X		X	X			E	X	X	X	X	
2-CHLOROPHENOL	X	X	X	X			E	X	X	X	X	G
2-CHLOROPROPANE	X	X	X	X			X	X	X	X	X	E
2-ETHOXYETHANOL	X	X	C	C	E	E	C	C	X	X	X	X
2-ETHOXYETHYL ACETATE	C		C	G	E	E	C	X	X	X	C	
2-ETHYL	X		G					X		X		X
2-ETHYL-1-HEXANOL	G	G	C	C	E	E	E	C	C	C	X	G
2-ETHYLHEXANOIC ACID	F		F					F		G		
2-ETHYLHEXYL ACETATE	X		E		C	C		X		G		
2-OCTANONE	X		G	G				X	C		X	X
3-BROMOPROPENE	X		X	X				X	X	X		G
3-CHLOROPROPENE	X	E	C	X	E	G	G	C	X	X		E
3-COAL OIL	X		X	X			E	E	G	F	F	
4-HYDROXY-4-METHYL-2-PENTANONE	X	X	E	E	E	E	X	X	F	C	X	X

Blank = No data

E = Excellent

G = Good

F = Fair

C = Conditional

X = Unsatisfactory

// PVC CHEMICAL RESISTANCE CHART

Chemical	Concentration	Temperature	
		20 °C 68 °F	60 °C 140 °F
Acetate Solvents		U	U
Acetic Acid	10%	A	C
Acetic Acid	Glacial	C	U
Acetone		U	U
Acrylonitrile		A	C
Adipic Acid		A	C
Alcohol Butyl		A	C
Alcohol Ethyl		A	C
Alcohol Isopropyl		A	C
Alcohol Methyl		A	C
Aluminum Acetate		A	
Aluminum Chloride		A	A
Aluminum Hydroxide		A	
Aluminum Sulfate		A	A
Allyl Chloride			
Ammonia	0.88 S.G. (Aqueous)	A	A
Ammonia	Dry Gas	A	
Ammonia	Liquid	U	U
Ammonium Chloride		A	A
Ammonium Hydroxide		A	
Animal Oils			
Amyl Acetate		U	U
Aniline Oils			
Aromatic Hydrocarbons		U	U
Asphalt		U	U
ASTM Fuel A		A	A
ASTM Fuel B		U	U
ASTM 1 Oil			
ASTM 3 Oil			
Barium Chloride		A	A
Barium Hydroxide		A	A
Barium Sulfide		A	A
Benzene		U	U
Benzine		C	C
Bordeaux Mixture		A	A
Borax		A	A
Boric Acid		A	A
Brine		A	A
Bromine Traces		U	U
Butyl Acetate		U	U
Calcium Hydroxide		A	A
Calcium Hypochlorite		A	A
Carbonic Acid		C	U
Carbon Dioxide		A	A
Carbon Disulphite		U	U
Carbon Monoxide		A	A
Carbon Tetrachloride		U	U
Casein		A	C
Chlorine	Dry gas	A	A
Chlorine	Wet Gas	C	U
Chlorine	Water	U	U
Chlorobenzene		U	U
Chlorinated Hydrocarbons		U	U
Chloroform		U	U
Chromic Acid	10%	A	C
Citric Acid		A	A
Coal Tar		U	U
Copper Chloride		A	A
Copper Nitrate		A	A
Copper Sulphate		A	A
Cottonseed Oil			

Chemical	Concentration	Temperature	
		20 °C 68 °F	60 °C 140 °F
Creosote		U	U
Cresol		A	C
Cresylic Acid		U	U
Cyclohexane		A	C
Cyclohexanone		U	U
DDT Weed Killer		A	C
Detergent Synthetic		A	A
Developers Photographic		A	A
Dextrin		A	A
Dextrose		A	A
Dibutyl Phthalate		U	U
Dichlorobenzene		U	U
Diesel Oil			
Diethylene Glycol		A	A
Diethyl Ether		U	U
Di-isodecyl Phthalate		U	U
Dicetyl Phthalate		U	U
Emulsifiers		A	A
Emulsions Photographic		A	A
Ethyl Acetate		U	U
Ethylene Dichloride		U	U
Ethylene Glycol		A	A
Fatty Acid		A	A
Ferric Chloride		A	A
Ferric Sulphate		A	A
Ferrous Chloride		A	A
Ferrous Sulphate		A	A
Fixing Solution Photographic	A	A	
Fluorine		U	U
Formaldehyde	40%	U	U
Formic Acid	40%	A	A
Formic Acid	50%	C	U
Formic Acid	100%	U	U
Fuel Oil			
Glacial Acetic Acid		C	U
Glucose		A	A
Glycerine		A	A
Grape Sugar		A	A
Grease			
Heptane		C	U
Hexane		C	U
Hydrobromic Acid		A	A
Hydrochloric Acid	10%	A	A
Hydrochloric Acid	40%	A	U
Hydrofluoric Acid	10%	A	C
Hydrofluoric Acid	40%	A	U
Hydrofluoboric Acid		A	A
Hydrofluosilicic Acid		A	A
Hydrogen Peroxide		A	
Hydrogen Sulphide		A	
Iso-octan		A	C
Isopropyl Acetate		U	U
Kerosene		C	C
Ketones		U	U
Lactic Acid	10%	A	
Lactic Acid	100%	U	U
Lacquer Solvents		C	U
Linseed Oil			
Lubricating Oils			
Magnesium Chloride		A	A
Magnesium Hydroxide		A	A

A : Satisfactory

C : Questionable - Suggest testing

U : Unsatisfactory

Blank : No data available

Chemical	Concentration	Temperature	
		20 °C 68 °F	60 °C 140 °F
Magnesium Sulphate		A	A
Malic Acid		A	A
Methyl Acetate		U	U
Methyl Bromide		U	U
Methyl Ethyl Ketone		U	U
Methylene Chloride		U	U
Mineral Oils			
Monochlorobenzene		U	U
Naphtha		C	U
Napthalene		C	U
Nitric Acid	10%	A	A
Nitric Acid	40%	A	C
Nitric Acid	70%	U	U
Nitrobenzene		U	U
Nitrogen Fertilizers		A	
Oleic Acid		A	C
Oxalic Acid		A	A
Palmitic Acid		A	A
Paraffin		A	A
Pentane		C	U
Perchloroethylene		U	U
Phenol		C	U
Phosphoric Acid		A	A
Pitch		A	C
Potassium Hydroxide		A	A
Propane		A	A
Sea Water		A	A
Sodium Hydroxide (caustic soda)	10%	A	A

Chemical	Concentration	Temperature	
		20 °C 68 °F	60 °C 140 °F
Sodium Hydroxide (caustic soda)	50%	A	U
Sodium Cyanide		A	A
Soybean Oil			
Stearic Acid		A	A
Styrene		U	U
Sulphur Dioxide	Dry	A	A
Sulphur Dioxide	Moist	C	U
Sulphur Dioxide	Liquid	U	U
Sulphuric Acid	45%	A	A
Sulphuric Acid	60%	C	C
Sulphuric Acid	98%	U	U
Sulphurous Acid	30%	A	
Tannic Acid		A	A
Tartaric Acid		A	A
Tetrahydrofuran		U	U
Toluene		U	U
Trichloroethylene		U	U
Triethanolamine		A	A
Triresyl Phosphate		U	U
Turpentine		C	U
Urea		A	A
Vinegar		A	A
Vinyl Acetate		U	U
Vinyl Chloride		U	U
Water		A	A
Xylene		U	U
Zinc Chloride		A	A
Zinc Sulphate		A	A

A : Satisfactory

C : Questionable - Suggest testing

U : Unsatisfactory

Blank : No data available

// FORMULAS AND CONVERSION FACTORS

LENGTH	mm	in	$\text{mm} \times 0,03937 = \text{in}$
	in	mm	$\text{in} \times 25,4001 = \text{mm}$
	m	ft	$\text{m} \times 3,2808 = \text{ft}$
	ft	m	$\text{ft} \times 0,3048 = \text{m}$
WEIGHT	kg	lb	$\text{kg} \times 2,20462 = \text{lb}$
	lb	kg	$\text{lb} \times 0,45359 = \text{kg}$
	kg/m	lb/ft	$\text{kg/m} \times 0,672 = \text{lb/ft}$
	lb/ft	kg/m	$\text{lb/ft} \times 1,488 = \text{kg/m}$
PRESSURE	bar	MPa	$\text{bar} \times 10^{-1} = \text{MPa}$
	MPa	bar	$\text{MPa} \times 10 = \text{bar}$
	bar	psi	$\text{bar} \times 14,504 = \text{psi}$
	psi	bar	$\text{psi} \times 0,068948 = \text{bar}$
	mm Hg	bar	$\text{mm Hg} \times 1,33322 \times 10^{-3} = \text{bar}$
TEMPERATURE	°C	°F	$9/5 \text{ } ^\circ\text{C} + 32 = \text{ } ^\circ\text{F}$
	°F	°C	$5/9 \times (\text{ } ^\circ\text{F} - 32) = \text{ } ^\circ\text{C}$

// INDUSTRIAL FITTINGS MANUAL

// COMPRESSED AIR

// EXPRESS NF E 29.573

	CONNECTION TYPE Symmetric coupling system The two symmetrical half-couplings have two claws each, which are connected by pushing them together and rotating the two claws to be 45° apart to form a seal.	WP = 10 bar
	INSERT TYPE Serrated insert with safety collar.	APPLICATION For air compressed and water applications.
	RECOMENDED FERRULE/CLAMPS (SEE TABLE A-B) <ul style="list-style-type: none"> Express clamps - 2 gripping finger type Worm gear clamp Crimping ring 	WARNING & NOTE Internal claw distance = 41 mm. Not interchangeable with Geka couplings and with other compressed air claw couplings (type A, type B, type S). Not to be used for steam application. As the connecting heads are the same on all parts, hose and threads of all dimensions can be connected together with no adaptors being required.

// TYPE A CLAW COUPLING (EUROPEAN TYPE)

	CONNECTION TYPE Symmetric coupling system The two symmetrical half-couplings have two claws each, which are connected by pushing them together and rotating the two claws to form a seal.	WP = 10 bar
	INSERT TYPE Serrated insert with safety collar.	APPLICATION For air compressed and water applications.
	RECOMENDED FERRULE/CLAMPS (SEE TABLE A-B) <ul style="list-style-type: none"> Claw Clamps Type A - DIN 20039B Worm Gear Clamp Two Bolt Saddle Clamp Crimping Ring Australian version: serrated ferrule for compressed air Type S	WARNING & NOTE Internal claw distance = 42 mm. Not interchangeable with Express, Geka couplings and with other compressed air claw couplings (type B, type S). Not to be used for steam application. As the connecting heads are the same on all parts, hose and threads of all dimensions can be connected together with no adaptors being required.

// TYPE A CLAW COUPLING (EUROPEAN TYPE)

	CONNECTION TYPE Symmetric coupling system The two symmetrical half-couplings have two claws each, which are connected by pushing them together and rotating the two claws to form a seal. For extra security, the presence of a safety pin inserted in the holes prevents accidental opening.	WP = 10 bar Australian version WP = 17.5 bar as per AS 2660/A requirements for air and water.
	INSERT TYPE Serrated insert with safety collar.	APPLICATION For air compressed and water applications.
	RECOMENDED FERRULE/CLAMPS (SEE TABLE A-B) <ul style="list-style-type: none"> Claw Clamps Type A - DIN 20039B Worm Gear Clamp Two Bolt Saddle Clamp Crimping Ring Australian version: serrated ferrule for compressed air Type S	WARNING & NOTE Internal claw distance = 42 mm. Not interchangeable with Express, Geka couplings and with other compressed air claw couplings (type B, type S). Not to be used for steam application. As the connecting heads are the same on all parts, hose and threads of all dimensions can be connected together with no adaptors being required.

// TYPE B CLAW COUPLING (U.S. TYPE)

	CONNECTION TYPE Symmetric coupling system The two symmetrical half-couplings have two claws each, which are connected by pushing them together and rotating the two claws to form a seal. For extra security, the presence of a safety pin inserted in the holes prevents accidental opening.	WP = 10 bar
	INSERT TYPE Serrated insert with safety collar.	APPLICATION For air compressed and water applications.
	RECOMENDED FERRULE/CLAMPS (SEE TABLE A-B) <ul style="list-style-type: none"> Claw Clamps Type B Crimping ring 	WARNING & NOTE Internal claw distance = 41 mm. Not interchangeable with Express, Geka couplings and with other compressed air claw couplings (type A, type S). Not to be used for steam application. As the connecting heads are the same on all parts, hose and threads of all dimensions can be connected together with no adaptors being required.

// TYPE S CLAW COUPLING (AUSTRALIAN TYPE)

	CONNECTION TYPE Symmetric coupling system The two symmetrical half-couplings have two claws each, which are connected by pushing them together and rotating the two claws to form a seal. For extra security, the presence of a safety pin inserted in the holes prevents accidental opening.	WP = 17.5 bar as per AS 2660/A requirements for air and water.
	INSERT TYPE Serrated insert with safety collar.	APPLICATION For air compressed and water applications.
	RECOMENDED FERRULE/CLAMPS (SEE TABLE A-B) <ul style="list-style-type: none"> Claw Clamps Type S - Australian Type Claw Clamps Type S - Australian Type with Safety Chain Serrated Ferrule for Compressed Air Type S 	WARNING & NOTE Internal claw distance = 45-74-117 mm (different for each DN). Not interchangeable with Express, Geka couplings and with other compressed air claw couplings (type A, type B).

// WATER

// TYPE GK CLAW COUPLING

	CONNECTION TYPE Symmetric coupling system The two symmetrical half-couplings have two claws each, which are connected by pushing them together and rotating the two claws to form a seal.	WP = 10 bar
	INSERT TYPE Serrated insert without locking collar.	APPLICATION For agricultural, gardening, irrigation, construction and public service applications.
	RECOMENDED FERRULE/CLAMPS (SEE TABLE A-B) <ul style="list-style-type: none"> • Band-it system • Clamps • Worm gear clamp • Crimping ring • Smooth ferrule 	WARNING & NOTE Internal claw distance = 40 mm. Not interchangeable with Express couplings and with other compressed air claw couplings (type A, type B, type S). Not to be used for steam application. As the connecting heads are the same on all parts, hose and threads of all dimensions can be connected together with no adaptors being required.

// TYPE B - BAUER COMPATIBLE

	CONNECTION TYPE Asymmetric coupling system: male & female part The male fitting has a double pin closure lever for smoother closing action. The male fitting is inserted into the female fitting and the joint closed by latching the lever over the head of the female fitting.	WP = 20 bar (DN 50mm / 89mm) WP = 12 bar (DN 108mm / 300mm)
	INSERT TYPE Ridged insert for clamps.	APPLICATION For different applications like: agriculture, irrigation, road construction, water delivery in the mines, suction line, civil projects, dewatering, by pass lines, chemical and food industry. Used in a wide range of water related applications and activities such as gully emptiers, sewage systems, fertiliser spraying and general water pumping.
	RECOMENDED FERRULE/CLAMPS (SEE TABLE A-B) <ul style="list-style-type: none"> • Band-it system • Clamps • Pw-clamp 	WARNING & NOTE Not interchangeable with type C - Cardan / Perrot compatible couplings.

// TYPE C - CARDAN/PERROT COMPATIBLE

	CONNECTION TYPE Asymmetric coupling system: male & female part The female fitting incorporates a thick o-ring seal and a closure lever with two-claws. The male fitting is inserted into the female fitting and the joint closed by latching the lever over the conical head of the male fitting.	WP = 12 bar
	INSERT TYPE Ridged insert for clamps.	APPLICATION For agricultural, irrigation, cleaning and construction applications. Most commonly used with systems carrying water, mortar, bitumen, bulk products. They assure the delivery of several media like: potable drinking water, waste water, sludge, bentonite, cement, compressed air in the most various applications like the food, pharmaceutical and chemical industries, irrigation, mining and tunneling, civil projects and dewatering.
	RECOMENDED FERRULE/CLAMPS (SEE TABLE A-B) <ul style="list-style-type: none"> • Band-it system • Clamps • Pw-clamp 	WARNING & NOTE Not interchangeable with type B - Bauer compatible couplings.

// VIDANGE

	CONNECTION TYPE Asymmetric coupling system: male & female part	WP = 6 bar
	INSERT TYPE Serrated insert without locking collar.	APPLICATION For water applications.
	RECOMENDED FERRULE/CLAMPS (SEE TABLE A-B) <ul style="list-style-type: none"> • Band-it system • Clamps • Pw-clamp • Smooth Ferrule 	WARNING & NOTE /

// TYPE 42

	CONNECTION TYPE Asymmetric coupling system: male & female part	WP = 12 bar (liquids)
	INSERT TYPE Ridged insert for clamps.	APPLICATION For water applications (irrigation systems). For different applications like: chemical industry, paper industry, process industry, for mobile water pipes in mining, steel and heavy industry. On sewage vehicles, on trucks for bulk transport of granulates (grain, flour, feed, pellets), concrete and minerals.
	RECOMENDED FERRULE/CLAMPS (SEE TABLE A-B) <ul style="list-style-type: none"> • Clamps 	WARNING & NOTE Not interchangeable with type B - Bauer compatible couplings. Not interchangeable with type C - Cardan / Perrot compatible couplings.

// HYGIENIC - FOOD

// SMS 1145

	<p>CONNECTION TYPE</p> <p>Asymmetric coupling system: male & female threaded end</p> <p>SMS food couplings are connected in the same way as DIN 11851 food couplings. The nut is slid across the head of the female coupling and onto the male coupling. The flat face of the female coupling is brought into contact with the turned-up seal of the male coupling. The nut is then tightened by hand or using a wrench. Threaded food couplings complying with SMS have a rounded thread complying with DIN 405/1. This rounded thread ensures that SMS food couplings are easy to connect by hand or using a wrench.</p>	<p>WP = 6 bar</p>
	<p>INSERT TYPE</p> <p>Serrated insert with EN 14 420-2 / DIN 2817 collar.</p>	<p>APPLICATION</p> <p>Used in food, beverage, chemical and pharmaceutical industries.</p>
	<p>RECOMENDED FERRULE/CLAMPS (SEE TABLE A-B)</p> <ul style="list-style-type: none"> • Serrated ferrule for hygienic coupling 	<p>WARNING & NOTE</p> <p>Supplied in Stainless Steel in order to meet the specifications of the Food Processing, Brewing, Dairy and Pharmaceutical industries.</p> <p>Food couplings complying with SMS (Swedish Manufacturing Standard) are not interchangeable with DIN 11851 food couplings. Although the threads of both couplings comply with DIN 405/1, precise dimensions vary, making them non-interchangeable.</p> <p>Female coupling = flat face Male coupling = turned-up seal Seal = square seal</p>

// DIN 11851

	<p>CONNECTION TYPE</p> <p>Asymmetric coupling system: male & female threaded end</p> <p>The seal must be inserted correctly into the seal sitting of the male coupling before connection. The conical female coupling is then pushed onto the male threaded coupling. The two are secured by sliding the nut across the conical head of the female coupling and onto the thread of the male coupling. The flanged seal enables easy assembly and prevents any displacement by vacuum or pressure. Threaded food couplings complying with DIN 11851 have a rounded thread complying with DIN 405/1. This rounded thread ensures that DIN 11851 compliant food couplings are easy to connect by hand or using a wrench.</p>	<p>WP = 40 bar / 25 bar (DN 15 mm / 100 mm)</p>
	<p>INSERT TYPE</p> <p>EN 14 420-2 / DIN 2817 smooth insert with collar.</p>	<p>APPLICATION</p> <p>Used in food, beverage, pharmaceutical and chemical industries.</p>
	<p>RECOMENDED FERRULE/CLAMPS (SEE TABLE A-B)</p> <ul style="list-style-type: none"> • Safety clamps en 14 420-3 / din 2817 • Safety clamps flexoline® • Serrated ferrule for hygienic coupling 	<p>WARNING & NOTE</p> <p>Supplied in Stainless Steel in order to meet the specifications of the Food Processing, Brewing, Dairy and Pharmaceutical industries.</p> <p>Food couplings complying with DIN 11851 are not interchangeable with SMS food couplings. Although the threads of both couplings comply with DIN 405/1, precise dimensions vary, making them non-interchangeable.</p> <p>Female coupling = conical face Male coupling = deep seal Seal = U-shape seal</p>

// DIN 11851

	<p>CONNECTION TYPE</p> <p>Asymmetric coupling system: male & female threaded end</p> <p>The seal must be inserted correctly into the seal sitting of the male coupling before connection. The conical female coupling is then pushed onto the male threaded coupling. The two are secured by sliding the nut across the conical head of the female coupling and onto the thread of the male coupling. The flanged seal enables easy assembly and prevents any displacement by vacuum or pressure. Threaded food couplings complying with DIN 11851 have a rounded thread complying with DIN 405/1. This rounded thread ensures that DIN 11851 food couplings are easy to connect by hand or using a wrench.</p>	<p>WP = 40 bar / 25 bar (DN 15 mm / 100 mm)</p>
	<p>INSERT TYPE</p> <p>Serrated insert with EN 14 420-2 / DIN 2817 collar.</p>	<p>APPLICATION</p> <p>Used in food, beverage, pharmaceutical and chemical industries.</p>
	<p>RECOMENDED FERRULE/CLAMPS (SEE TABLE A-B)</p> <ul style="list-style-type: none"> • Serrated ferrule for hygienic coupling 	<p>WARNING & NOTE</p> <p>Supplied in Stainless Steel in order to meet the specifications of the Food Processing, Brewing, Dairy and Pharmaceutical industries.</p> <p>Food couplings complying with DIN 11851 are not interchangeable with SMS food couplings. Although the threads of both couplings comply with DIN 405/1, precise dimensions vary, making them non-interchangeable.</p> <p>Female coupling = conical face Male coupling = deep seal Seal = U-shape seal</p>

// MACON

	CONNECTION TYPE Asymmetric coupling system: male & female threaded end	WP = 10 bar
	INSERT TYPE Serrated insert with locking collar.	APPLICATION Especially designed for wine industry in France.
	RECOMENDED FERRULE/CLAMPS (SEE TABLE A-B) <ul style="list-style-type: none"> Serrated ferrule for hygienic coupling 	WARNING & NOTE -

// STEAM

// EN 14 423 / DIN 2826

	<p>CONNECTION TYPE</p> <p>Asymmetric coupling system: male & female threaded end</p> <p>Symmetric coupling system: flanged end</p> <p>Steam couplings complying with EN 14423/ DIN 2826 are available in female and male threaded screw couplings and in flanged couplings.</p>	<p>WP max = 18 bar with a temperature of 210°C / BP=180 bar</p>
	<p>INSERT TYPE</p> <p>EN 14 423 / DIN 2826 serrated insert with collar.</p>	<p>APPLICATION</p> <p>To be used for saturated steam (up to +210° C) and hot water (up to +120° C) with a working pressure up to 18 bar.</p>
	<p>RECOMENDED FERRULE/CLAMPS (SEE TABLE A-B)</p> <ul style="list-style-type: none"> • Safety clamps EN 14 423 / DIN 2826 	<p>WARNING & NOTE</p> <p>Steam couplings complying with EN 14423 / DIN 2826 are used to assemble steam hoses complying with EN ISO 6134. The serrated hose shank with collar is designed to be assembled with steam clamps complying with EN 14423 / DIN 2826. Under no circumstances safety clamps EN 14420-3 / DIN 2817 shall be used. Compared with EN 14420-2 / DIN 2817 smooth hose shanks, steam hose shanks complying with EN 14423 / DIN 2826 are serrated and are physically longer and larger.</p>

// GROUND JOINT SEAL

	<p>CONNECTION TYPE</p> <p>Asymmetric coupling system: male & female threaded end</p> <p>The coupling system consists of a male threaded insert (with a serrated hose shank with safety collar for safety clamps) and a female threaded complete coupling composed by 3 elements: a female stem (with a serrated hose shank with safety collar for safety clamps), a female threaded spud and a swivel nut.</p>	<p>WP max = 41 bar</p>
	<p>INSERT TYPE</p> <p>Serrated insert with safety collar.</p>	<p>APPLICATION</p> <p>Designed for steam and high pressure compressed air and other high pressure or hazardous applications requiring a safety coupling and clamp assembly. This reusable, rugged coupling can be fitted or re-attached in the field without special equipment. Widely used in oil refineries, chemical plants and other factories using steam as an essential service. Used for compressed air (especially in larger sizes), in quarrying, mining, pile driving, as well as other service duties. Also used for LPG, grouting, volatile liquids and similar applications.</p>
	<p>RECOMENDED FERRULE/CLAMPS (SEE TABLE A-B)</p> <ul style="list-style-type: none"> • Clamps - 2 Bolt - 2 Gripping Finger Type • Clamps - 4 Bolt - 2 Gripping Finger Type • Clamps - 6 Bolt - 3 Gripping Finger Type 	<p>WARNING & NOTE</p> <p>/</p>

// TURNEX P

	CONNECTION TYPE Asymmetric coupling system: female threaded end	WP = 25 bar
	INSERT TYPE Serrated insert with locking collar / serrated insert without locking collar.	APPLICATION Used in petrochemical plants in France.
	RECOMENDED FERRULE/CLAMPS (SEE TABLE A-B) <ul style="list-style-type: none"> • Alfacrimp hydraulic serrated ferrule (H1200004-xx0000) 	WARNING & NOTE /

// SYMMETRIC GUILLEMIN

// SYMMETRIC GUILLEMIN NF E 29.572

	CONNECTION TYPE Symmetric coupling system A coupling system in which both halves are identical. Couplings have locking rings to connect and secure the other half. This is the French standard tanker connection. The coupling is connected by simply putting the two halves together and turning a tapered locking ring which tightens into a tapered channel on the other half of the coupling making a tight, secure connection. Couplings can be connected by hand or with the aid of spanners designed for the purpose.	WP = 16 bar
	INSERT TYPE Serrated insert with locking collar / serrated insert without locking collar.	APPLICATION For pressure and suction delivery of liquid (general industrial, water, hydrocarbons, chemicals) and solids (powders, granules).
	RECOMENDED FERRULE/CLAMPS (SEE TABLE A-B) <ul style="list-style-type: none"> • Band-it system • Clamps • Crimping ring • Smooth ferrule 	WARNING & NOTE Symmetric Guillemin Couplings are not interchangeable with DSP/AR couplings. Not to be used for steam or liquid gas application.

// SYMMETRIC DSP & AR (NF S 61.704 - NF S 61.705)

// SYMMETRIC DSP NF S 61.704

	CONNECTION TYPE Symmetric coupling system These French hose couplings are symmetrical, clamp fitting and hose tail are one piece fitted with a locking ring. By turning the locking ring the bosses are pushed underneath the two strips of the mating coupling.	WP = 16 bar
	INSERT TYPE Serrated insert without locking collar.	APPLICATION For fire fighting application. DSP couplings are used for pressure (delivery) purposes in the fire fighting field.
	RECOMENDED FERRULE/CLAMPS (SEE TABLE A-B) <ul style="list-style-type: none"> • Band-it system • Worm gear clamp • Clamps • Crimping ring • Smooth ferrule 	WARNING & NOTE Symmetric DSP/AR Couplings are not interchangeable with Symmetric Guillemin Couplings. They differ from Guillemin Couplings by the preformed bosses on the locking ring respect the strips on the lugs.

// SYMMETRIC AR NF S 61.705

	CONNECTION TYPE Symmetric coupling system These French hose couplings are symmetrical, clamp fitting and hose tail are one piece fitted with a locking ring. By turning the locking ring the bosses are pushed underneath the two strips of the mating coupling.	WP = 16 bar
	INSERT TYPE Serrated insert without locking collar.	APPLICATION For fire fighting application. AR couplings are used for suction & delivery purposes in the fire fighting field.
	RECOMENDED FERRULE/CLAMPS (SEE TABLE A-B) <ul style="list-style-type: none"> • Band-it system • Worm gear clamp • Clamps • Crimping ring • Smooth ferrule 	WARNING & NOTE Symmetric DSP/AR Couplings are not interchangeable with Symmetric Guillemin Couplings. They differ from Guillemin Couplings by the preformed bosses on the locking ring respect the strips on the lugs.

// GFR - ROUND THREAD COUPLING NF E 29.579

// GFR - ROUND THREAD COUPLING NF E 29.579

	CONNECTION TYPE Asymmetric coupling system male & female threaded end	WP = 16 bar WP = 25 bar (DN 20 mm)
	INSERT TYPE Serrated insert without locking collar.	APPLICATION For air, nitrogen and water in petrochemical plants and refineries in France.
	RECOMENDED FERRULE/CLAMPS (SEE TABLE A-B) <ul style="list-style-type: none"> • Band-it system • Clamps • Crimping ring • Smooth ferrule 	WARNING & NOTE /

// STORZ

// STORZ

	CONNECTION TYPE Symmetric coupling system A straight through coupling in which both halves are identical. Each half has forward projecting lugs and mating recesses. Any two parts with the same lug dimensions will connect together. This is the standard German tanker connection. The coupling is connected by simply locating the lugs into the recesses of each half and turning clockwise up to the stop (a 120° rotation). One half of the coupling normally has a swivel head which prevents hose / pipe twists when connecting. Couplings can be connected by hand or with the aid of spanners designed for the purpose.	WP = 16 bar
	INSERT TYPE Ridged insert for clamps.	APPLICATION Used for liquids, powders and granulates. The storz system was originally designed for fire fighting equipment. it is suitable for water and a wide range of other fluids. It has also been adopted for use with powder blowing systems.
	RECOMENDED FERRULE/CLAMPS (SEE TABLE A-B) <ul style="list-style-type: none"> • Band-it system • Clamps • Crimping ring • Smooth ferrule 	WARNING & NOTE Different lug spaced units can be used to prevent accidental cross line contamination.

// TANKWAGEN

// TANKWAGEN EN 14 420-6 / DIN 28 450

	<p>CONNECTION TYPE</p> <p>Asymmetric coupling system male & female part</p> <p>To be screwed on BSPP male fittings. The locking lever fitted to the female (MK) coupling engages in the rim of the male (VK) part. It's turned until both halves are tightly compressed. The locking lever is then pushed downwards.</p>	<p>WP = 25 bar</p>
	<p>INSERT TYPE</p> <p>/</p>	<p>APPLICATION</p> <p>Used for transport of liquids, solids and gases, with exception of liquefied gas and steam. Potential areas of application are stationary and mobile tanking facilities, forwarding/ tanking and silo vehicles, chemical industry, food industry, plant and power station construction and shipbuilding.</p>
	<p>Recommended Ferrule/Clamps (See table A-B)</p> <p>/</p>	<p>WARNING & NOTE</p> <p>/</p>

// CAM & GROOVE

// CAM & GROOVE MIL A-A-59326A / MIL C-27487

	CONNECTION TYPE Asymmetric coupling system: male adapter & female coupler The coupling is connected by simply opening the coupler arms and inserting the adapter into the coupler. The cam arms are then closed under normal hand pressure to complete joint.	WP = 11 bar / 3 bar (DN 1/2" / 8")
	INSERT TYPE Ridged insert for clamps / serrated insert without locking collar.	APPLICATION Used for transfer of liquid or dry bulk products with exception of liquid gas or steam. For pipe, hose, tubing and tanks conveying liquids, powders, vapours & gases including cooling water, fuels, chemicals, cosmetics, foodstuffs, offshore, pumps, adhesives, dyes, pharmaceuticals, pellets and many more. Couplings applicable to almost any industry that uses liquids, powders and gases.
	RECOMENDED FERRULE/CLAMPS (SEE TABLE A-B) <ul style="list-style-type: none"> • Band-it system • Worm gear clamp • Clamps • Smooth ferrule 	WARNING & NOTE Not to be used for compressed air and steam application.

// CAM & GROOVE EN 14 420-7 / DIN 2828

	CONNECTION TYPE Asymmetric coupling system: male adapter & female coupler The coupling is connected by simply opening the coupler arms and inserting the adaptor into the coupler. The cam arms are then closed under normal hand pressure to complete joint.	WP = 18 bar / 7 bar (DN 3/4" / 4")
	INSERT TYPE EN 14 420-2 / DIN 2817 smooth insert with collar.	APPLICATION Used for transfer of liquid or dry bulk products with exception of liquid gas or steam. For pipe, hose, tubing and tanks conveying liquids, powders, vapours & gases including cooling water, fuels, chemicals, cosmetics, foodstuffs, offshore, pumps, adhesives, dyes, pharmaceuticals, pellets and many more. Couplings applicable to almost any industry that uses liquids, powders and gases.
	RECOMENDED FERRULE/CLAMPS (SEE TABLE A-B) <ul style="list-style-type: none"> • Safety clamps EN 14 420-3 / DIN 2817 • Safety clamps flexoline • ® 	WARNING & NOTE Not to be used for steam or liquid gas application. Couplings CAM & GROOVE (EN 14420-7 / DIN 2828) are interchangeable with couplings CAM & GROOVE (MIL C - 27.487) as coupling side but differ in term of hose shank design and thread side. A flat PTFE thread seal has been added to the female threaded parts compared to Cam & Groove (MIL C - 27.487).

// COMBINATION NIPPLE

// COMBINATION NIPPLE FOR CLAMPING

	CONNECTION TYPE Asymmetric coupling system: male threaded end Symmetric coupling system: plain end	WP = 10 bar The WP varies with size of the combination nipple, the size and construction of the hose and the type of clamping system used.
	INSERT TYPE Serrated insert without locking collar.	APPLICATION For all suction and discharge hose applications at low pressure. For oil, petroleum, water (widely used in offshore rig operations by oil companies), volatile fluids, abrasives and dry products.
	RECOMENDED FERRULE/CLAMPS (SEE TABLE A-B) <ul style="list-style-type: none"> • Band-it system • Worm gear clamp • Clamps • Smooth ferrule 	WARNING & NOTE Not to be used for compressed air application. Hose nipples made from tubular stock; threaded male end, in all style, has the same size as hose.

// ALFACRIMP COMBINATION NIPPLE

	CONNECTION TYPE Asymmetric coupling system: Male threaded end	WP = 25 bar
	INSERT TYPE Industrial "one-piece" (precrimped serrated insert).	APPLICATION For all suction and discharge hose applications at low pressure. For oil, petroleum, water (widely used in offshore rig operations by oil companies), volatile fluids, abrasives and dry products.
	RECOMENDED FERRULE/CLAMPS (SEE TABLE A-B) <ul style="list-style-type: none"> • DN ≥ 3": industrial precrimped ferrule 	WARNING & NOTE /

// EN 14 420-5 / DIN 2817

// EN 14 420-5 / DIN 2817

	CONNECTION TYPE Asymmetric coupling system: male & female threaded end	WP = 25 bar
	INSERT TYPE EN 14 420-2 / DIN 2817 smooth insert with collar.	APPLICATION Potential Areas of Application are chemical, petrochemical, pharmaceutical industry, food industry and blast furnaces.
	RECOMENDED FERRULE/CLAMPS (SEE TABLE A-B) <ul style="list-style-type: none"> • Safety clamps EN 14 420-3 / DIN 2817 • Safety clamps flexoline® • Serrated ferrule suitable to EN 14 420-2 / DIN 2817 	WARNING & NOTE Screw hose couplings EN 14420-5 / DIN 2817 are not interchangeable with steam hose couplings EN 14 423 / DIN 2826, due to differences in application and overall dimensions.

// AVIATION

// EN 14 420-5 / DIN 2817

	CONNECTION TYPE Asymmetric coupling system: male & female threaded end	WP = 25 bar
	INSERT TYPE EN 14 420-2 / DIN 2817 smooth insert with collar.	APPLICATION For aircraft ground fuelling and defuelling application.
	RECOMENDED FERRULE/CLAMPS (SEE TABLE A-B) <ul style="list-style-type: none"> • Safety clamps EN 14 420-3 / DIN 2817 • Serrated ferrule 	WARNING & NOTE Different from the standard screw hose couplings EN 14420-5 / DIN 2817 for the material: produced in tinned brass for aviation refuelling service.

// BSPP MALE THREADED FITTING

	CONNECTION TYPE Asymmetric coupling system: male threaded end	WP = 25 bar
	INSERT TYPE Serrated insert with EN 14 420-2 / DIN 2817 collar.	APPLICATION For aircraft ground fuelling and defuelling application.
	RECOMENDED FERRULE/CLAMPS (SEE TABLE A-B) <ul style="list-style-type: none"> • Safety clamps EN 14 420-3 / DIN 2817 • Serrated ferrule 	WARNING & NOTE /

// SANDBLAST

// SANDBLAST - QUICK COUPLING

	CONNECTION TYPE Symmetric coupling system A coupling system related to claw couplings, always identical head dimensions and therefore always interchangeable.	WP = 12 bar
	INSERT TYPE External insert secured by screws into the hose.	APPLICATION Used on all stationary and mobile blasting machines and plants.
	Recommended Ferrule/Clamps (See table A-B) /	WARNING & NOTE Internal claw distance = 58 mm

// MORTAR

// MORTAR - INSERT FOR CLAMPS

	CONNECTION TYPE Asymmetric coupling system: male adapter & female coupler Asymmetric coupling system: male threaded end The principle of the Mortar coupling is similar to Cam & Groove Coupling, but both are not interchangeable.	WP max = 50 bar
	INSERT TYPE Serrated insert without locking collar.	APPLICATION For mortar and concrete lines on pumps, spraying-devices, plastering machine, ect.
	RECOMENDED FERRULE/CLAMPS (SEE TABLE A-B) <ul style="list-style-type: none"> • Band-it system • Crimping ring • Smooth ferrule 	WARNING & NOTE Note that there are two different Systems used in the market: System 22 and System 23,5. Attention: only fittings with same coupling-size and same system are interchangeable.

// MORTAR - INSERT FOR SERRATED FERRULE

	CONNECTION TYPE Asymmetric coupling system: male adapter & female coupler Asymmetric coupling system: male threaded end The principle of the Mortar coupling is similar to Cam & Groove Coupling, but both are not interchangeable.	WP max = 50 bar
	INSERT TYPE Serrated insert with locking collar.	APPLICATION For mortar and concrete lines on pumps, spraying-devices, plastering machine, ect.
	RECOMENDED FERRULE/CLAMPS (SEE TABLE A-B) <ul style="list-style-type: none"> • Serrated ferrule 	WARNING & NOTE Note that there are two different Systems used in the market: System 22 and System 23,5. Attention: only fittings with same coupling-size and same system are interchangeable. Not present in ALFAGOMMA catalogue.

// CONCRETE

// CONCRETE - HARDENED INSERT COMPLETE WITH PRECRIMPED FERRULE

	CONNECTION TYPE Symmetric coupling system: grooved end - indirect connection through joint clamps <ul style="list-style-type: none"> • Victaulic style • Shouldered style • California style Asymmetric coupling system: male & female threaded end <ul style="list-style-type: none"> • BSPT/NPT male • BSPP female Asymmetric coupling system: male & female part <ul style="list-style-type: none"> • Schwing style 	WP = 100 bar
	INSERT TYPE Concrete "one-piece" (precrimped serrated insert).	APPLICATION For high pressure concrete pumping.
	RECOMENDED FERRULE/CLAMPS (SEE TABLE A-B) <ul style="list-style-type: none"> • Concrete precrimped ferrule 	WARNING & NOTE /

// FLANGED FITTING

// FIXED FLANGE EN 1092-1 PN 10/16 - SERRATED INSERT COMPLETE WITH PRE-CRIMPED FERRULE

	CONNECTION TYPE Symmetric coupling system: flanged end	WP = 16 / 25 bar
	INSERT TYPE Industrial "one-piece" (precrimped serrated insert).	APPLICATION For all suction and discharge hose applications at low pressure. For oil, petroleum, water and other fluids (chemicals included).
	RECOMENDED FERRULE/CLAMPS (SEE TABLE A-B) <ul style="list-style-type: none"> • DN = 3" - 6": industrial precrimped ferrule 	WARNING & NOTE /

// FIXED FLANGE EN 1092-1 PN 10/16 - SERRATED INSERT

	CONNECTION TYPE Symmetric coupling system: flanged end	WP = 16 / 25 bar
	INSERT TYPE Serrated insert with locking collar.	APPLICATION For all suction and discharge hose applications at low pressure. For oil, petroleum, water and other fluids (chemicals included).
	RECOMENDED FERRULE/CLAMPS (SEE TABLE A-B) <ul style="list-style-type: none"> • Serrated ferrule 	WARNING & NOTE /

// FIXED FLANGE ASME ANSI B 16.5 - ASA 150 - SERRATED INSERT COMPLETE WITH PRE-CRIMPED FERRULE

	CONNECTION TYPE Symmetric coupling system: flanged end	WP = 16 / 25 bar
	INSERT TYPE Industrial "one-piece" (precrimped serrated insert).	APPLICATION For all suction and discharge hose applications at low pressure. For oil, petroleum, water and other fluids (chemicals included).
	RECOMENDED FERRULE/CLAMPS (SEE TABLE A-B) <ul style="list-style-type: none"> • DN = 3"- 6": industrial precrimped ferrule 	WARNING & NOTE /

// FIXED FLANGE ASME ANSI B 16.5 - ASA 150 - SERRATED INSERT

	CONNECTION TYPE Symmetric coupling system: flanged end	WP = 16 / 25 bar
	INSERT TYPE Serrated insert with locking collar.	APPLICATION For all suction and discharge hose applications at low pressure. For oil, petroleum, water and other fluids (chemicals included).
	RECOMENDED FERRULE/CLAMPS (SEE TABLE A-B) <ul style="list-style-type: none"> • Serrated ferrule 	WARNING & NOTE /

// SWIVEL FLANGE EN 1092-1 PN 10/16 - SERRATED INSERT COMPLETE WITH PRE-CRIMPED FERRULE

	CONNECTION TYPE Symmetric coupling system: flanged end	WP = 16 / 25 bar
	INSERT TYPE Industrial "one-piece" (precrimped serrated insert).	APPLICATION For all suction and discharge hose applications at low pressure. For oil, petroleum, water and other fluids (chemicals included).
	RECOMENDED FERRULE/CLAMPS (SEE TABLE A-B) • DN = 3" - 6": industrial precrimped ferrule	WARNING & NOTE /

// SWIVEL FLANGE EN 1092-1 PN 10/16 - SERRATED INSERT

	CONNECTION TYPE Symmetric coupling system: flanged end	WP = 16 / 25 bar
	INSERT TYPE Serrated insert with locking collar.	APPLICATION For all suction and discharge hose applications at low pressure. For oil, petroleum, water and other fluids (chemicals included).
	RECOMENDED FERRULE/CLAMPS (SEE TABLE A-B) • Serrated ferrule	WARNING & NOTE /

// SWIVEL FLANGE EN 1092-1 PN 10/16 - EN 14 420-2 / DIN 2817 HOSE SHANK

	CONNECTION TYPE Symmetric coupling system: flanged end	WP = 25 bar
	INSERT TYPE EN 14 420-2 / DIN 2817 smooth insert with collar.	APPLICATION For all suction and discharge hose applications at low pressure. For oil, petroleum, water and other fluids (chemicals included).
	RECOMENDED FERRULE/CLAMPS (SEE TABLE A-B) • Safety clamps EN 14 420-3 / DIN 2817 • Safety clamps flexoline®	WARNING & NOTE /

// SWIVEL FLANGE ASME ANSI B 16.5 - ASA 150 - SERRATED INSERT COMPLETE WITH PRE-CRIMPED FERRULE

	CONNECTION TYPE Symmetric coupling system: flanged end	WP = 16 / 25 bar
	INSERT TYPE Industrial "one-piece" (precrimped serrated insert).	APPLICATION For all suction and discharge hose applications at low pressure. For oil, petroleum, water and other fluids (chemicals included).
	RECOMENDED FERRULE/CLAMPS (SEE TABLE A-B) <ul style="list-style-type: none"> • DN = 3" - 6": industrial precrimped ferrule 	WARNING & NOTE /

// SWIVEL FLANGE ASME ANSI B 16.5 - ASA 150 - SERRATED INSERT

	CONNECTION TYPE Symmetric coupling system: flanged end	WP = 16 / 25 bar
	INSERT TYPE Serrated insert with locking collar.	APPLICATION For all suction and discharge hose applications at low pressure. For oil, petroleum, water and other fluids (chemicals included).
	RECOMENDED FERRULE/CLAMPS (SEE TABLE A-B) <ul style="list-style-type: none"> • Serrated ferrule 	WARNING & NOTE /

// FIXED FLANGE - SPLIT COUPLING - AS 2129 TABLE D

	CONNECTION TYPE Symmetric coupling system: flanged end	WP = 10 bar
	INSERT TYPE Muff coupling with external insert clamped with screwed bolts on external hose diameter.	APPLICATION For bulk material and abrasive slurries suction and delivery in heavy duty mining.
	Recomended Ferrule/Clamps (See table A-B) /	WARNING & NOTE /

// CLAMPS & FERRULES FOR ASSEMBLY

// INSERT TYPE

Drawing example	Insert type (ind)	Ferrule/clamps To be used for assembly
	Serrated insert with locking collar	Serrated ferrule
	Serrated insert without locking collar	Smooth ferrule - Crimping ring - Clamps - Band-it
	Standard insert for clamp Ridged insert for clamp	Smooth ferrule - Crimping ring - Clamps - Band-it
	Serrated insert with EN 14 420-2 - DIN 2817 collar	EN 14 420-3 - DIN 2817 safety clamps Serrated ferrule suitable for EN 14 420-2 - DIN 2817 hose shank
	EN 14 420-2 - DIN 2817 smooth insert with collar	EN 14 420-3 - DIN 2817 safety clamps
	EN 14 423 - DIN 2826 serrated insert with collar	EN 14 423 - DIN 2826 safety clamps
	Concrete "One-piece" - Precrimped serrated insert (full flow)	Concrete serrated ferrule already precrimped to the fitting
	Industrial "One-piece" - Precrimped serrated insert	Industrial serrated ferrule already precrimped to the fitting
	External insert fixed by screws	Secured by screws into the hose (no ferrule & clamps needed)
	External insert - Muff coupling	Clamped by screwed bolts on external hose diameter (no ferrule & clamps needed)
	Composite hose insert (helical hose shank)	Smooth ferrule for composite hose
	Built-in insert	Insert bonded to hose during construction (no ferrule needed)

// TABLE A: FERRULES

Ferrule type (ind)	Ferrule drawing
	Crimping ring
	Smooth ferrule for composite hose (Suitable for industrial hose)
	Serrated ferrule
	Industrial precrimped serrated ferrule
	Concrete precrimped serrated ferrule

// TABLE B: CLAMPS

Clamps drawing	Clamp family
	Express clamps
	Type A claw clamps - DIN20039B
	Type B claw clamps
	Type S (australian type) claw clamps
	Loose saddle&saf.Claw clamps
	Boss clamps - ground joint
	Safety clamps EN 14 423 / DIN 2826
	Safety clamps EN 14 420-3 / DIN 2817
	Loose saddle clamps
	Loose saddle clamps - DIN20039A

// TABLE B: CLAMPS

Clamps drawing	Clamp family
	Ear pinch on clamp
	Miniclamp
	Worm gear clamp
	Spiral clamp - double bridge
	Bolt superclamp
	PW clamp
	Band-it band & band-it buckles
	Preformed band clamp
	Rubber lined clips
	Exhaust pipe clamp

// INDUSTRIAL HOSE & RACOMMENDED FITTING TABLES

// COMPRESSED AIR – HOSE CHAPTER

		195AT	191AK	180AA	185AA/AH/AK	186AA	175AA/AH/AK	155AA/AK	140AK	142AK	132AE
	Express	●	●	●	●	●	●				
	Claw Couplings EU	●	●	●	●	●	●	●			
	Claw Couplings USA	●	●	●	●	●	●	●			
	Claw Couplings AUS	●	●	●	●	●	●	●			
	Geka	●	●	●	●	●	●				
	Ground Joint Seal							●	●	●	
	Combination nipples precrimped ferrule							●	●		
	Hydraulic Fittings	●	●	●	●	●	●	●	●	●	●

The match hose/fitting is just an indication and needs checking depending on the actual application.
The final choice is on Customer's responsibility

// HOT AIR – HOSE CHAPTER

		952AA	902AA	902AE	902LE	903LE
	Cardan-Perrot	●				
	Type 42		●			
	SMS					●
	DIN 11851				●	●
	Symmetric Guilfemin		●		●	●
	Storz	●	●		●	●
	Cam & Groove	●	●	●	●	●
	TW Couplings: EN 14 420-6 DIN 28 450	●			●	●
	Flange PN10/16 ASA150		●			

The match hose/fitings is just an indication and needs checking depending on the actual application.
The final choice is on Customer's responsibility

// WATER & LIQUIDS – HOSE CHAPTER

		49000	49200	284AA/AH	286EE/288HH	250AA	253AA	254AA/AH	256AA	264GL	266GL/KL/OL	265TH	267BE	269BA	268BL	47200	204AA	202AA	223AA	221AA	222AA	248AE	
	Type GK claw coupling	●	●	●				●															
	Bauer				●	●	●	●				●		●			●	●			●		
	Cardan-Perrot				●	●	●	●		●	●	●	●	●	●	●	●	●				●	
	Type 42									●	●	●	●	●	●								
	Symmetric Guillemin									●	●		●	●	●	●		●					
	Storz				●		●	●		●	●	●	●	●	●	●		●				●	
	Cam & Groove		●	●	●	●	●	●		●	●	●	●	●	●	●	●	●				●	
	Combination nipple	●	●	●		●	●	●				●		●		●	●					●	
	Combination nipple precrimped Ferrule							●	●								●	●	●				
	Flange PN10/16 ASA150				●	●	●	●	●							●	●	●	●	●	●	●	
	Hydraulic Fittings							●	●											●			●

* Flange with pre-crimped ferrule not to be used

The match hose/fitings is just an indication and needs checking depending on the actual application.
The final choice is on Customer's responsibility

// FIRE FIGHTING – HOSE CHAPTER

					
	Gros filet rond couplings	Symmetric Guillemain	Symmetric DSP & AR	Storz	Fire Fighting Couplings
283AA				•	•
251AA	•				•
212AA		•	•	•	•

// HOT WATER & STEAM – HOSE CHAPTER

				
	Hydraulic Fittings	Turnex P	Ground Joint Seal	EN 14 423 - DIN 2826 couplings
350AA	•		•	
354AA				•
350LL/LE	•		•	
340AA/AH	•		•	
344AH				•
343AH	•		•	
341AA/AH	•	•	•	
345AA				•

The match hose/fittings is just an indication and needs checking depending on the actual application. The final choice is on Customer's responsibility

// LIQUID FOOD – HOSE CHAPTER

		49200	4660L	4680H	47200	452LH	402LH	410LL	412LE	418LE	455LE/LL	405LE/LL/LH	417LE
	SMS	•	•	•	•	•	•	•	•	•	•	•	•
	DIN 11851	•	•	•	•	•	•	•	•	•	•	•	•
	Macon		•	•		•							
	Symmetric Guillemín	•	•	•	•	•	•	•	•	•	•	•	•
	Storz		•	•	•								
	Cam & Groove	•	•	•	•	•	•	•	•		•	•	•
	TW Couplings								•	•	•	•	•
	EN14 420-5 / DIN 2817								•	•	•	•	•





The match hose/fittings is just an indication and needs checking depending on the actual application.
The final choice is on Customer's responsibility

// BULK FOOD – HOSE CHAPTER

				
	SMS	DIN 11851	Symmetric Guillemin	Cam & Groove
760LA	●	●	●	●
760LB				●
720LA	●	●	●	●
720LG				●

The match hose/fitings is just an indication and needs checking depending on the actual application.
The final choice is on Customer's responsibility

// BULK MATERIAL – HOSE CHAPTER



		760AA	766AA	720AA	767AL	780AA
	Bauer		●		●	●
	Cardan-Perrot	●	●	●		
	Type 42	●	●	●		
	Symmetric Guillemin	●	●	●		
	Storz	●	●	●		
	Cam & Groove	●	●	●	●	●
	Combination ripple		●		●	
	Flange PN10/16 ASA150			●		

The match hose/fitting is just an indication and needs checking depending on the actual application.
The final choice is on Customer's responsibility

// PLASTER – HOSE CHAPTER





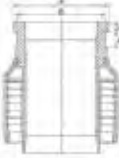
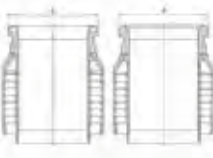
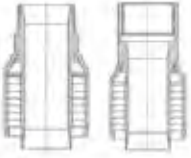



			
	Cardan-Perrot	Storz (hose ID 45 mm)	Mortar Couplings
764OL		•	
752AA	•		
757AA			•
758AA			•
758AE			•

// CONCRETE – HOSE CHAPTER

					
	Victaulic style	Shouldered style	California style	Schwing style	Male & Female threaded fittings
737AA	•	•			•
740AA	•	•	•	•	•
741AA	•	•	•	•	•

The match hose/fitings is just an indication and needs checking depending on the actual application.
The final choice is on Customer's responsibility

// ACID, CHEMICAL & MULTIPURPOSE – HOSE CHAPTER

		984AH	974AH	975AH	954AH	976AB	956AB	503AA	505OG	529AA	509OE	538AA
	Claw Couplings EU-AUS		●									
	Symmetric Guillemin							●	●	●	●	
	Cam & Groove							●	●	●	●	
	TW Couplings						●	●	●	●	●	●
	EN 14 420-5 DIN 2817						●	●	●	●	●	●
	Combination nipple precrimped Ferrule							●	●		●	
	Flange PN10/16 ASA150							●	●	●	●	
	Hydraulic Fittings	●	●	●	●	●	●	●	●	●	●	●

The match hose/fittings is just an indication and needs checking depending on the actual application.
The final choice is on Customer's responsibility

// HYDROCARBONS – HOSE CHAPTER

		650AA/AH	650AB	668EL	601AA	605AA	605AH	629AA	655AA	619AA	620AA
	Symmetric Guillemin					●	●	●			
	Cam & Groove	●	●	●	●	●	●	●	●	●	
	TW Couplings EN 14 420-6 DIN 28 450	●	●			●		●	●	●	●
	EN14 420-5 DIN 2817	●	●			●		●	●	●	●
	Combination nipple	●	●	●		●	●	●			
	Combination nipple precrimped Ferrule	●			●	●	●	●	●	●	●
	Flange PN10/16 ASA150	●	●		●	●	●	●	●	●	●
	Hydraulic Fittings	●	●	●		●	●	●	●	●	●

The match hose/fitings is just an indication and needs checking depending on the actual application.
The final choice is on Customer's responsibility

			
	EN 14 420-5 DIN 2817	Hydraulic Fittings	Volucompteur*
658AA	●	●	●
659AA	●	●	

* Available on request

		
	EN14 420-5 DIN 2817 Aviation	Male Aviation
656AA	●	●
611AA	●	●

The match hose/fitings is just an indication and needs checking depending on the actual application.
The final choice is on Customer's responsibility

// DOCK – HOSE CHAPTER

			
	Combination nipple precrimped Ferrule	Crimped Fitting with flange PN10/16 ASA150	Built-in Fitting with flange PN10/16 ASA150
60DAA			•
64AAA			•
60NAA	•	•	
60GAA			•
64DAA			•
60PAA	•	•	
64PAA	•	•	

The match hose/fitings is just an indication and needs checking depending on the actual application.
The final choice is on Customer's responsibility

// RIG SUPPLY – HOSE CHAPTER

		
	Combination nipple precrimped Ferrule	Flange PN10/16 ASA150
648AA	•	•
615AA	•	•
622AA	•	•
748AA	•	•
715AA	•	•
448LI	•	•
415LI	•	•

The match hose/fitings is just an indication and needs checking depending on the actual application.
The final choice is on Customer's responsibility

// MINING – HOSE CHAPTER

						
	Compr. Air Claw Coupling	Bauer	Ground Joint Seal	Cam & Groove	Combination nipple precrimped Ferrule	Hydraulic Fittings
151AA	•					•
151AK	•					•
157AK			•			•
189AK	•					•
146AK						•
141AA			• *		•	•
289GG		•		•		
240AA	•				•	•
241AA	• *					•
225AA				• **	•	•
245AA				• *		
765AA				• **		
776AA/HA			•			

* Pay attention:
 - hose WP higher than fitting WP
 - hose assembly must be used at fitting working pressure

** Brass

	
	Muff coupling with Flange
706AA	•

The match hose/fitings is just an indication and needs checking depending on the actual application. The final choice is on Customer's responsibility

// INDUSTRIAL HOSE**// DUCTING & VENTILATION**

161BL	Air ducting	11
163AL	General purpose.....	11
174BB	Air ducting - High temperature +100 °C (+212 °F).....	12
178AA	Air ducting - High temperature +120 °C (+248 °F).....	12
17100	Air ducting - Polyurethane - Gauge 0,4 mm	13
17200	Air ducting - Polyurethane - Gauge 0,8 mm	13
17300	Air ducting - Polyurethane - Gauge 1,2 mm	14
17700	Air ducting - Polyurethane - Gauge 1,7 mm.....	14

// GAS & WELDING

081AE	Oxygen 20 bar (300 psi).....	16
081AH	Acetylene 20 bar (300 psi)	16
088AI	LPG-natural gas 25 bar (375 psi).....	16
076AE	Oxygen welding 20 bar (300 psi).....	17
076AH	Acetylene welding 20 bar (300 psi).....	17
076AI	LPG welding 20 bar (300 psi).....	17
076EH	Oxygen/acetylene twin welding 20 bar (300 psi).....	18
076EI	Oxygen/LPG twin welding 20 bar (300 psi)	18
071AI	LPG welding 12 bar (180 psi).....	19
071EH	Oxygen/acetylene twin welding 12 bar (180 psi)	19
071EI	Oxygen/LPG twin welding 12 bar (180 psi).....	19

// COMPRESSED AIR

195AT	Compressed air 20 bar (300 psi) - Polyurethane - Pneumatic tools.....	22
191AK	Compressed air 20 bar (300 psi) - PVC.....	22
180AA	Compressed air 20 bar (300 psi).....	23
185AA	Compressed air 20 bar (300 psi) - Standard duty	23
185AH	Compressed air 20 bar (300 psi) - Standard duty	24
185AK	Compressed air 20 bar (300 psi) - Standard duty	24
186AA	Compressed air 20 bar (300 psi) - Heavy duty	24
175AA	Compressed air 20 bar (300 psi) - Standard duty	25
175AH	Compressed air 20 bar (300 psi) - Standard duty	25
175AK	Compressed air 20 bar (300 psi) - Standard duty	25
155AA	Compressed air 20 bar (300 psi) - Heavy duty	26
155AK	Compressed air 20 bar (300 psi) - Heavy duty	26
140AK	Compressed air - Steel braided.....	27
142AK	Compressed air 40 bar (600 psi) - High temperature - Oil resistant - Steel braided	27
132AE	Compressed air 80 bar (1200 psi) - High temperature - Steel braided.....	28
179AA	Push-loc/push-on	28
179AB	Push-loc/push-on	28
165AA	Air brake 10 bar (150 psi).....	29
166AA	Air brake 20 bar (300 psi)	29
160AA	Railway air brake 20 bar (300 psi).....	29

// INDUSTRIAL HOSE**// HOT AIR**

952AA	Hot air blower 10 bar (150 psi) - Soft wall - External textile braid.....	31
962LA	Hot air blower 10 bar (150 psi) - Soft wall.....	31
902AA	Hot air blower 10 bar (150 psi) - Hard wall.....	32
902AE	Hot air blower 10 bar (150 psi) - Hard wall.....	32
902LE	Hot air blower 10 bar (150 psi) - Hard wall.....	33
903LE	Hot air blower 10 bar (150 psi) - Hard wall.....	33

// WATER & LIQUIDS

49000	General purpose tubing - PVC.....	36
49200	General purpose food quality - PVC.....	36
284AA	Water delivery 10 bar (150 psi).....	37
284AH	Water delivery 10 bar (150 psi).....	37
286EE	Water discharge - PVC - Lay flat - Standard duty.....	38
288HH	Water discharge - PVC - Lay flat - Heavy duty.....	38
250AA	Water discharge 5 bar (75 psi) - Lay flat.....	39
253AA	Water discharge 10 bar (150 psi) - Lay flat.....	39
254AA	Air-water delivery 10 bar (150 psi).....	40
254AH	Air-water delivery 10 bar (150 psi).....	40
256AA	Water-irrigation 18 bar (270 psi) - Heavy duty.....	40
264GL	Water S&D - PVC - Light duty.....	41
266GL	Water S&D - PVC - Standard duty.....	41
266KL	Water S&D - PVC - Standard duty.....	42
266OL	Water S&D - PVC - Standard duty - Super elastic.....	42
265TH	Water-slurry S&D - PVC - Standard duty - Super elastic.....	43
267BE	Water-slurry S&D - PVC - Medium duty - Super elastic.....	43
269BA	Water-slurry S&D - PVC/NBR - Medium duty - Superior flexibility.....	44
268BL	Water-abrasive slurry S&D - PVC - Heavy duty.....	44
47200	General purpose food quality S&D - PVC.....	45
204AA	Water S&D 5 bar (75 psi).....	46
202AA	General purpose S&D 10 bar (150 psi) - EPDM.....	46
223AA	Water S&D 20 bar (300 psi) - Heavy duty.....	47
221AA	Water-slurry S&D - Corrugated - Soft ends.....	47
222AA	Heavy duty dewatering - EPDM - Corrugated - Soft ends.....	48
268LL	Pools-spa water circulation.....	48
248AE	High pressure water delivery 100 bar (1500 psi) - Snow maker - Steel braided.....	49

// AGRICULTURE

591AE	Crop spraying 40 bar (600 psi) - PVC.....	51
593AK	Crop spraying 80 bar (1200 psi) - PVC.....	51
2660A	Air seeder - PVC.....	52
702AA	Air seeder.....	52

// FIRE FIGHTING

283AA	Fire reel 12 bar (180 psi).....	54
251AA	Fire reel 40 bar (600 psi) - Textile braided.....	54

// INDUSTRIAL HOSE

212AA	Fire engine water S&D 5 bar (75 psi).....	54
-------	---	----

// FURNACE & CABLE COOLING

254AL	Furnace cooling 10 bar (150 psi) - Soft wall.....	56
203AL	Furnace cooling 10 bar (150 psi) - Hard wall.....	56
957LL	Cable cooling 20 bar (300 psi) - Non conductive.....	57

// HOT WATER & STEAM

375AA	Hot water-car heater 10 bar (150 psi).....	60
352AA	Radiator 5 bar (75 psi).....	60
395BT	Hot water wash down 50 bar (750 psi).....	61
351LL	Hot water wash down 10 bar (150 psi) - Built in nozzle.....	61
351LG	Hot water wash down 10 bar (150 psi) - Built in nozzle.....	61
350LL	Steam 6 bar (90 psi) - Hot water 15 bar (225 psi).....	62
350LE	Steam 6 bar (90 psi) - Hot water 15 bar (225 psi).....	62
350AA	Steam 6 bar (90 psi) - Hot water 15 bar (225 psi).....	63
354AA	Steam 6 bar (90 psi).....	63
340AA	Steam 18 bar (270 psi) - Steel braided.....	64
340AH	Steam 18 bar (270 psi) - Steel braided.....	64
344AH	Steam 18 bar (270 psi) - Steel braided.....	65
343AH	Steam 18 bar (270 psi) - Oil resistant - Steel braided.....	65
341AA	Steam 18 bar (270 psi) - CIIR - Steel braided.....	66
341AH	Steam 18 bar (270 psi) - CIIR - Steel braided.....	66
345AA	Steam 18 bar (270 psi) - CIIR - Steel braided.....	66

// LIQUID FOOD

49200	General purpose food quality - PVC.....	70
4660L	General purpose S&D - PVC - Standard duty.....	70
4680H	Liquid food S&D - PVC - Heavy duty.....	71
47200	General purpose food quality S&D - PVC.....	71
452LH	Liquid food delivery 10 bar (150 psi).....	72
402LH	Liquid food S&D 10 bar (150 psi).....	72
410LL	Alcoholic beverages S&D 16 bar (240 psi) - Crush resistant.....	73
412LE	Milk tanker 10 bar (150 psi) - Hard wall.....	74
418LE	Milk tanker 10 bar (150 psi) - Hard wall - Crush resistant.....	74
455LE	Fat food delivery 10 bar (150 psi).....	75
455LL	Fat food delivery 10 bar (150 psi).....	75
405LE	Fat food S&D 10 bar (150 psi).....	76
405LL	Fat food S&D 10 bar (150 psi).....	76
405LH	Fat food S&D 10 bar (150 psi).....	77
417LE	Fat food S&D 16 bar (240 psi) - Crush resistant.....	77

// BULK FOOD

760LA	Bulk food delivery 5 bar (75 psi).....	83
760LB	Bulk food delivery 5 bar (75 psi).....	83
720LA	Bulk food S&D 10 bar (150 psi).....	84

// INDUSTRIAL HOSE

720LG	Bulk food S&D 10 bar (150 psi)	84
9670E	Fish handling - PVC - Super elastic	85
949AA	Fish pump 3 bar (45 psi)	85

// BULK MATERIAL

760AA	Bulk material delivery 5 bar (75 psi)	87
766AA	Bulk material delivery 10 bar (150 psi)	87
720AA	Bulk material S&D 10 bar (150 psi)	88
767AL	Bulk material S&D - PVC - Polyurethane lined	88
780AA	Bulk material S&D - PVC	89

// SANDBLAST

753AA	Sandblast 12 bar (180 psi) - Premium quality	91
753AH	Sandblast 12 bar (180 psi) - Premium quality	91
753AG	Sandblast 12 bar (180 psi) - Premium quality	92
755AA	Sandblast 12 bar (180 psi) - Top quality	92

// PLASTER

7640L	Plaster conveyance - Polyurethane	94
752AA	Plaster 10 bar (150 psi)	94
757AA	Plaster 40 bar (600 psi)	94
758AA	Plaster 55 bar (800 psi)	95
758AE	Plaster 55 bar (800 psi)	95

// CONCRETE

754AA	Concrete vibrator 10 bar (150 psi)	97
737AA	Concrete pumping 40 bar (600 psi)	97
740AA	Concrete pumping 85 bar (1275 psi) - Heavy duty - Steel reinforced	98
741AA	Concrete pumping 100 bar (1500 psi) - Extra service - Steel reinforced	98

// ACID CHEMICAL & MULTIPURPOSE

984AH	Multipurpose 20 bar (300 psi)	100
974AH	Multipurpose 17 bar (250 psi) - Non conductive	100
975AH	Multipurpose 20 bar (300 psi) - Non conductive	101
954AH	Multipurpose 20 bar (300 psi) - Non conductive	101
976AB	General purpose 20 bar (300 psi) - EPDM	102
956AB	General purpose 20 bar (300 psi) - EPDM	102
503AA	Acid-chemical S&D 16 bar (240 psi) - EPDM	103
5050G	Acid-chemical S&D 16 bar (240 psi) - XLPE	103
529AA	Acid-chemical S&D 16 bar (240 psi) - UPE	104
5090E	Acid-chemical S&D 16 bar (240 psi) - UPE	104
5190E	Acid-chemical S&D 16 bar (240 psi) - UPE - Corrugated	105
538AA	Tank cleaning 20 bar (300 psi) - EPDM - Textile braided	105

// HYDROCARBONS

687AA	Automotive fuel 10 bar (150 psi)	108
-------	--	-----

// INDUSTRIAL HOSE

689AA	Automotive fuel 10 bar (150 psi) - External textile braid	108
688AA	Diesel oil delivery 15 bar (225 psi) - External steel braid	108
680AA	Fuel-oil delivery 10 bar (150 psi)	109
671AA	Fuel-oil delivery 16 bar (240 psi)	109
650AA	Fuel-oil delivery 10 bar (150 psi)	110
650AH	Fuel-oil delivery 10 bar (150 psi)	110
650AB	Fuel-oil delivery 10 bar (150 psi)	111
668EL	Fuel-oil S&D - PVC - Heavy duty	111
601AA	Oil rigger-fracking S&D 10 bar (150 psi)	112
605AA	Fuel-oil S&D 10 bar (150 psi)	112
605AH	Fuel-oil S&D 10 bar (150 psi)	113
629AA	Biofuel S&D 10 bar (150 psi)	113
606AE	Tank truck 10 bar (150 psi) - Corrugated - Low temperature	113
655AA	Fuel-oil delivery 16 bar (240 psi)	114
619AA	Fuel-oil S&D 16 bar (240 psi)	114
620AA	Fuel-oil S&D 20 bar (300 psi)	115
658AA	Domestic fuel reeling 16 bar (240 psi) - Textile braided	115
659AA	LPG delivery 25 bar (375 psi) - Textile braided	116
656AA	Aircraft ground fuelling 20 bar (300 psi)	117
611AA	Aircraft ground fuelling-defuelling 20 bar (300 psi)	117
614AA	Hot tar 10 bar (150 psi)	118

// MARINE

266LL	Marine sanitary hose - PVC	120
202LL	Marine sanitary hose 7 bar (100 psi)	120
653AA	Marine exhaust - Soft wall	121
6E1AA	Marine exhaust - Hard wall	122
605AA	Fuel-oil S&D 10 bar (150 psi)	123

// DOCK

60DAA	Fuel-oil S&D 10 bar (150 psi)	125
64AAA	Fuel-oil delivery 10 bar (150 psi)	125
60NAA	Fuel-oil S&D 15 bar (225 psi)	126
60GAA	Fuel-oil S&D 15 bar (225 psi)	126
64DAA	Fuel-oil delivery 15 bar (225 psi)	127
60PAA	Fuel-oil S&D 20 bar (300 psi)	127
64PAA	Fuel-oil delivery 20 bar (300 psi)	128

// FLOATING ROOF DRAIN

906AA	Roof drain 10 bar (150 psi)	130
-------	-----------------------------------	-----

// RIG SUPPLY

648AA	Rig supply soft wall - Fuel-liquid mud 20 bar (300 psi)	132
615AA	Rig supply hard wall - Fuel-liquid mud 20 bar (300 psi)	132
622AA	Rig supply hard wall - Fuel-liquid mud	133
748AA	Rig supply soft wall - Bulk material 20 bar (300 psi)	134

// INDUSTRIAL HOSE

715AA	Rig supply hard wall - Bulk material 20 bar (300 psi).....	134
448LI	Rig supply soft wall - Potable water 20 bar (300 psi).....	135
415LI	Rig supply hard wall - Potable water 20 bar (300 psi).....	135

// MINING

151AA	Compressed air 20 bar (300 psi) - Heavy duty mining.....	140
151AK	Compressed air 20 bar (300 psi) - Heavy duty mining.....	140
157AK	Compressed air 27 bar (400 psi) - Heavy duty mining.....	141
189AK	Air-water delivery - PVC - FRAS.....	141
146AK	Compressed air-water 70 bar (1000 psi) - Steel braided.....	142
141AA	Compressed air 40 bar (600 psi) - Steel braided - FRAS.....	142
289GG	Mine dewatering - PVC - Lay flat.....	143
240AA	Air-water delivery 20 bar (300 psi) - FRAS.....	143
241AA	Air-water delivery 35 bar (525 psi).....	143
225AA	General purpose S&D 10 bar (150 psi) - FRAS.....	144
245AA	General purpose delivery & light suction 27 bar (400 psi) - Crush resistant - FRAS.....	144
756AA	Gunite 14 bar (200 psi) - FRAS.....	145
765AA	Stone dust 7 bar (100 psi) - FRAS.....	145
706AA	Abrasive slurry S&D 10 bar (150 psi) - Muff couplings.....	145
776AA	Mineral sampling 35 bar (525 psi).....	146
776HA	Mineral sampling 35 bar (525 psi).....	146
714HA	Drill cutting suction 5 bar (75 psi) - Corrugated.....	146
612AA	Nitro blast handling 20 bar (300 psi).....	147
964AA	Cable protection - FRAS.....	147

// INDUSTRIAL FITTINGS

// COMPRESSED AIR

// EXPRESS NF E 29.573

Hose shank complete with seal - Brass	151
BSPP Male complete with seal - Brass	151
BSPP Female complete with seal - Brass	151
Blank cap complete with seal - Brass	152
Seal - NBR	152
Clamp - 2 gripping finger type - Plated steel	152

// TYPE A CLAW COUPLING (EUROPEAN TYPE)

Hose shank with safety collar and safety pin holes - complete with seal - Plated steel	153
BSPT Male with safety pin holes - complete with seal - Plated steel	153
BSPP Female with safety pin holes - complete with seal - Plated steel	153
Blank cap with safety pin holes - complete with seal - Plated steel	154
Three way connector with safety pin holes - complete with seal - Plated steel	154
Seal - NBR	154
Seal - Silicone	154
Claw clamp (A-Europe) - DIN 20 039 B - Malleable iron	155

// TYPE B CLAW COUPLING (U.S. TYPE)

Hose shank with safety collar and safety pin holes - complete with seal - Malleable iron	156
Hose shank with safety collar and safety pin holes - 4 Lug type - complete with seal - Malleable iron	156
NPT Male with safety pin holes - complete with seal - Malleable iron	156
NPT Female with safety pin holes - complete with seal - Malleable iron	157
NPT Female with safety pin holes - 4 Lugs - complete with seal - Malleable iron	157
Blank cap with safety pin holes - complete with seal - Malleable iron	157
Three way connector with safety pin holes - complete with seal - Malleable iron	158
Seal - NBR	158
Claw clamp (B-U.S.) - Malleable iron	158

// TYPE S CLAW COUPLING (AUSTRALIAN TYPE)

Hose shank with safety collar complete with seal - Plated steel	159
BSPT Male complete with seal - Plated steel	159
BSPP Female complete with seal - Plated steel	160
Three way connector complete with seal - Plated steel	160
Seal - NBR	160

// HOSE MENDER

Hose shank with safety collar for claw clamps - Plated steel	161
Hose shank without safety collar - Plated steel	161

// CLAW COUPLING - ACCESSORY

Safety Pin - AU type (A-Europe / B-U.S.A. / S-Australia) - Plated steel	162
Safety Pin - standard type (A-Europe / B-U.S.A. / S-Australia) - Plated steel	162

// CLAW COUPLING - CLAMP & FERRULE

Claw clamp (A-Europe complete with safety pin holes / S-Australia) - Plated steel	163
Claw clamp with safety chain lugs (S-Australia) - Plated steel	163
Claw clamp complete with safety chain (S-Australia) - Plated steel	163
Serrated ferrule (A-Europe complete with safety pin holes / S-Australia) - Plated steel	164
Serrated ferrule (S-Australia) - Plated steel	164

// INDUSTRIAL FITTINGS**// WATER****// TYPE GK CLAW COUPLING**

Hose shank complete with seal - Brass.....	166
BSPP Male complete with seal - Brass.....	166
BSPP Female complete with seal - Brass.....	166
Blank cap complete with seal - Brass.....	167
Seal - NBR.....	167

// TYPE B - BAUER COMPATIBLE

Male with closure lever - Hose shank - Plated steel.....	168
Male without closure lever - Heavy duty hose shank - Plated steel.....	168
Closure lever - Plated steel.....	168
Female - Hose shank complete with seal - Plated steel.....	169
Female - Heavy duty hose shank - without seal - Plated steel.....	169
Male without closure lever - Black weld on - Unplated steel.....	169
Female complete with seal - Black weld on - Unplated steel.....	170
Male with closure lever - BSPT Male - Plated steel.....	170
Female complete with seal - BSPT Male - Plated steel.....	170
Male with closure lever - BS10 Table D fixed flange - Plated steel.....	171
Female complete with seal - BS10 Table D fixed flange - Plated steel.....	171
Seal - SBR.....	171
Antioil Rubber Seal - NBR.....	172

// TYPE C - CARDAN/PERROT COMPATIBLE

Male - Hose shank - Plated steel.....	173
Female with closure lever - Hose shank complete with seal - Plated steel.....	173

// VIDANGE

Male - Hose shank - Brass.....	174
Female complete with seal - Hose shank - Brass.....	174

// TYPE 42

Male - Hose shank - Plated steel.....	175
Female with closure lever complete with seal - Hose shank - Plated steel.....	175
Male - Weld on - Plated steel.....	176
Female with closure lever complete with seal - Weld on - Plated steel.....	176
Male - BSPT Male - Plated steel.....	176
Female with closure lever complete with seal - BSPT Male - Plated steel.....	176
Male plug - Plated steel.....	177
Female cap with closure lever complete with seal - Plated steel.....	177
Seal - NBR.....	177
Seal - EPDM.....	177

// SHOULDERED STYLE

Low Pressure - Serrated hose shank complete with pre-crimped ferrule - Plated steel.....	178
--	-----

// HYGIENIC - FOOD**// SMS 1145**

Male - Serrated hose shank with collar - complete with seal - Stainless steel 316.....	180
Female - Serrated hose shank with collar - Stainless steel 316.....	180

// INDUSTRIAL FITTINGS**// DIN 11851**

Male - EN 14 420-2 / DIN 2817 hose shank complete with seal - Stainless steel 316.....	181
Female - EN 14 420-2 / DIN 2817 hose shank - Stainless steel 316.....	181
Male - Serrated hose shank complete with seal - Stainless steel 316.....	182
Female with round nut - Serrated hose shank - Stainless steel 316.....	182

// MACON

Male - Serrated hose shank with collar - Stainless steel 316.....	183
Female with round nut - Serrated hose shank with collar complete with seal - Stainless steel 316.....	183

// HYGIENIC COUPLING - FERRULE

Serrated ferrule - for hygienic coupling - Stainless steel 304.....	183
---	-----

// STEAM**// EN 14 423 / DIN 2826**

BSPT Male - Hose shank EN 14 423 / DIN 2826 - Brass.....	185
BSPT Male - Hose shank EN 14 423 / DIN 2826 - Stainless steel 316.....	185
BSPP Female - Hose shank EN 14 423 / DIN 2826 - Brass.....	186
BSPP Female - Hose shank EN 14 423 / DIN 2826 - Stainless steel 316.....	186
PN40 swivel flange - Hose shank EN 14 423 / DIN 2826 - Plated steel.....	187
PN40 swivel flange - Hose shank EN 14 423 / DIN 2826 - Stainless steel 316.....	187
Safety clamps - Brass.....	187

// GROUND JOINT SEAL

BSPT Male - Serrated hose shank with safety collar - Plated steel.....	188
BSPT Male - Serrated hose shank with safety collar - Malleable iron.....	188
NPT Male - Serrated hose shank with safety collar - Malleable iron.....	188
BSPP Female complete with wing nut and seal - Serrated hose shank with collar - Malleable iron.....	189
NPT Female complete with wing nut and seal - Serrated hose shank with collar - Malleable iron.....	189
Clamps - 2 bolt - 2 gripping finger type - Malleable iron.....	189
Clamps - 4 bolt - 2 gripping finger type - Malleable iron.....	190
Clamps - 6 bolt - 3 gripping finger type - Malleable iron.....	190

// TURNEX P

Female with wing nut - Serrated hose shank with safety collar - Plated steel.....	190
---	-----

// SYMMETRIC GUILLEMIN**// SYMMETRIC GUILLEMIN NF E 29.572 - HOSE SHANK**

Serrated hose shank - with locking ring complete with seal - Aluminium.....	192
Serrated hose shank - with locking ring complete with seal - Stainless steel 316.....	192
Serrated hose shank - with locking ring complete with seal - Bronze.....	192
Serrated hose shank with collar - with locking ring complete with seal - Aluminium.....	193
Serrated hose shank with collar - with locking ring complete with seal - Stainless steel 316.....	193
Serrated hose shank with collar - with locking ring complete with seal - Bronze.....	193

// SYMMETRIC GUILLEMIN NF E 29.572 - ADAPTER

Symmetric with locking ring complete with seal - BSPP Male - Aluminium.....	194
Symmetric with locking ring complete with seal - BSPP Male - Stainless steel 316.....	194
Symmetric with locking ring complete with seal - BSPP Male - Bronze.....	194

// INDUSTRIAL FITTINGS

Symmetric without locking ring complete with seal - BSPP Male - Aluminium.....	195
Symmetric without locking ring complete with seal - BSPP Male - Stainless steel 316.....	195
Symmetric without locking ring complete with seal - BSPP Male - Bronze.....	195
Symmetric with locking ring complete with seal - BSPP Female - Aluminium.....	196
Symmetric with locking ring complete with seal - BSPP Female - Stainless steel 316.....	196
Symmetric with locking ring complete with seal - BSPP Female - Bronze.....	196
Symmetric without locking ring complete with seal - BSPP Female - Aluminium.....	197
Symmetric without locking ring complete with seal - BSPP Female - Stainless steel 316.....	197
Symmetric without locking ring complete with seal - BSPP Female - Bronze.....	197
Reducing adapter with locking rings complete with seal - Aluminium.....	198
Male plug with locking ring and chain - Aluminium.....	199
Male plug with locking ring and chain - Stainless steel 316.....	199
Male plug with locking ring and chain - Bronze.....	199
Handled male plug without locking ring - with chain - Aluminium.....	200

// SYMMETRIC GUILLEMIN NF E 29.572 - SEAL & ACCESSORY

Seal - NBR.....	201
Seal - white NBR - food grade.....	201
Seal - PTFE.....	201
Wrenches - Universal - Plated steel.....	202
Wrenches - Universal - Bronze.....	202
Wrenches - Simple - Plated steel.....	202
Wrenches - Simple - Copper Alloy.....	202
Wrenches - Oil tanker - Copper Alloy.....	202

// SYMMETRIC DSP & AR (NF S 61.704 - NF S 61.705)**// SYMMETRIC DSP NF S 61.704**

Serrated hose shank with locking ring complete with seal - Aluminium.....	204
---	-----

// SYMMETRIC AR NF S 61.705

Serrated hose shank with locking ring complete with seal - Aluminium.....	204
---	-----

// GFR - ROUND THREAD COUPLING NF E 29.579**// GFR - ROUND THREAD COUPLING NF E 29.579 - HOSE SHANK**

GFR Male - Hose shank - Bronze.....	206
GFR swivel Female - Hose shank complete with seal - Bronze.....	206

// STORZ**// STORZ - HOSE SHANK**

Suction & delivery hose shank complete with seal - Aluminium.....	208
---	-----

// STORZ - ADAPTER

BSPP Male complete with seal - Aluminium.....	209
BSPP Female complete with seal - Aluminium.....	210
Reducer adapter complete with seal - Aluminium.....	210
Blank cap with chain complete with seal - Aluminium.....	211

// INDUSTRIAL FITTINGS**// TANKWAGEN****// TANKWAGEN EN 14 420-6 / DIN 28 450**

Type VK - Male part - BSPP Female - Stainless steel 316.....	213
Type VK - Male part - BSPP Female - Brass.....	213
Type MK - Female part complete with locking handle and seal - BSPP Female - Stainless steel 316.....	213
Type MK - Female part complete with locking handle and seal - BSPP Female - Brass.....	213
Type VB - Male plug - Aluminium.....	214
Type VB - Male plug - Stainless steel 316.....	214
Type VB - Male plug - Brass.....	214
Type VB - Male plug - PP.....	214
Type MB - Female Cup - Aluminium.....	215
Type MB - Female Cup - Stainless steel 316.....	215
Type MB - Female Cup - Brass.....	215
Profiled Seal for type MK - NBR.....	216
Profiled Seal for type MK - CSM.....	216
Profiled Seal for type MK - FKM/FPM.....	216
Square Seal for type MK and VK thread end - PTFE.....	216
Square Seal for type MK and VK thread end - Polyurethane.....	217
Square Seal for type MB - NBR.....	217
Square Seal for type MB - CSM.....	217

// CAM & GROOVE**// CAM & GROOVE MIL A-A-59326A / MIL C-27487 - TYPE A**

Type A - Adapter, BSPP Female - Aluminium.....	219
Type A - Adapter, BSPP Female - Stainless steel 316.....	219
Type A - Adapter, BSPP Female - Brass.....	220
Type A - Adapter, BSPP Female - PP.....	220
Type A - Adapter, NPT Female - Aluminium.....	221
Type A - Adapter, NPT Female - Stainless steel 316.....	221
Type A - Adapter, NPT Female - Brass.....	222
Type A - Adapter, NPT Female - PP.....	222

// CAM & GROOVE MIL A-A-59326A / MIL C-27487 - TYPE B

Type B - Coupler, BSPT Male - Aluminium.....	223
Type B - Coupler, BSPT Male - Stainless steel 316.....	223
Type B - Coupler, BSPT Male - Brass.....	224
Type B - Coupler, BSPT Male - PP.....	224
Type B - Coupler, NPT Male - Aluminium.....	225
Type B - Coupler, NPT Male - Stainless steel 316.....	225
Type B - Coupler, NPT Male - Brass.....	226
Type B - Coupler, NPT Male - PP.....	226

// CAM & GROOVE MIL A-A-59326A / MIL C-27487 - TYPE C

Type C - Coupler, hose shank - Aluminium.....	227
Type C - Coupler, hose shank - Stainless steel 316.....	227
Type C - Coupler, hose shank - Brass.....	228
Type C - Coupler, hose shank - PP.....	228

// CAM & GROOVE MIL A-A-59326A / MIL C-27487 - TYPE D

Type D - Coupler, BSPP Female - Aluminium.....	229
--	-----

// INDUSTRIAL FITTINGS

Type D - Coupler, BSPP Female - Stainless steel 316.....	229
Type D - Coupler, BSPP Female - Brass.....	230
Type D - Coupler, BSPP Female - PP.....	230
Type D - Coupler, NPT Female - Aluminium.....	231
Type D - Coupler, NPT Female - Stainless steel 316.....	231
Type D - Coupler, NPT Female - Brass.....	232
Type D - Coupler, NPT Female - PP.....	232

// CAM & GROOVE MIL A-A-59326A / MIL C-27487 - TYPE E

Type E - Adapter, hose shank - Aluminium.....	233
Type E - Adapter, hose shank - Stainless steel 316.....	233
Type E - Adapter, hose shank - Brass.....	234
Type E - Adapter, hose shank - PP.....	234

// CAM & GROOVE MIL A-A-59326A / MIL C-27487 - TYPE F

Type F - Adapter, BSPT Male - Aluminium.....	235
Type F - Adapter, BSPT Male - Stainless steel 316.....	235
Type F - Adapter, BSPT Male - Brass.....	236
Type F - Adapter, BSPT Male - PP.....	236
Type F - Adapter, NPT Male - Aluminium.....	237
Type F - Adapter, NPT Male - Stainless steel 316.....	237
Type F - Adapter, NPT Male - Brass.....	238
Type F - Adapter, NPT Male - PP.....	238

// CAM & GROOVE MIL A-A-59326A / MIL C-27487 - TYPE DC

Type DC - Female dust cap for adapter - Aluminium.....	239
Type DC - Female dust cap for adapter - Stainless steel 316.....	239
Type DC - Female dust cap for adapter - Brass.....	240
Type DC - Female dust cap for adapter - PP.....	240

// CAM & GROOVE MIL A-A-59326A / MIL C-27487 - TYPE DP

Type DP - Male dust plug for coupler - Aluminium.....	241
Type DP - Male dust plug for coupler - Stainless steel 316.....	241
Type DP - Male dust plug for coupler - Brass.....	242
Type DP - Male dust plug for coupler - PP.....	242

// CAM & GROOVE EN 14 420-7 / DIN 2828 - TYPE A

Type AF - Adapter, BSPP Female - PTFE Seal - Stainless steel 316.....	243
---	-----

// CAM & GROOVE EN 14 420-7 / DIN 2828 - TYPE C

Type CC - Coupler, EN 14 420-2 / DIN 2817 hose shank - Stainless steel 316.....	243
---	-----

// CAM & GROOVE EN 14 420-7 / DIN 2828 - TYPE D

Type DF - Coupler, BSPP Female - PTFE Seal - Stainless steel 316.....	244
---	-----

// CAM & GROOVE EN 14 420-7 / DIN 2828 - TYPE E

Type EE - Adapter, EN 14 420-2 / DIN 2817 hose shank - Stainless steel 316.....	244
---	-----

// CAM & GROOVE - SEAL

Seal - NBR.....	245
Seal - FKM/FPM.....	245
Seal - Closed envelope - PTFE.....	245

// INDUSTRIAL FITTINGS

// CAM & GROOVE - ACCESSORY

Handle, Ring & Pin - Stainless steel 316.....	246
---	-----

// COMBINATION NIPPLE

// COMBINATION NIPPLE FOR CLAMPING

BSPT Male - Hose shank for clamping - Plated steel.....	248
NPT Male - Hose shank for clamping - Plated steel.....	248
Hose shank for clamping - Plated steel.....	249

// ALFACRIMP COMBINATION NIPPLE

BSPT Male complete with pre-crimped ferrule - Plated steel.....	250
BSPT Male complete with pre-crimped ferrule - Stainless steel 316.....	250
NPT Male complete with pre-crimped ferrule - Plated steel.....	251
NPT Male complete with pre-crimped ferrule - Stainless steel 316.....	251

// EN 14 420-5 / DIN 2817

// EN 14 420-5 / DIN 2817 - HOSE SHANK

BSPP Male - EN 14 420-2 / DIN 2817 hose shank - Stainless steel 316.....	253
BSPP Male - EN 14 420-2 / DIN 2817 hose shank - Brass.....	253
BSPP Female with swivel nut - EN 14 420-2 / DIN 2817 hose shank - Stainless steel 316.....	254
BSPP Female with swivel nut - EN 14 420-2 / DIN 2817 hose shank - Brass.....	254

// AVIATION

// EN 14 420-5 / DIN 2817 - HOSE SHANK

BSPP Male - EN 14 420-2 / DIN 2817 hose shank - Tinned Brass.....	256
BSPP Female with swivel nut - EN 14 420-2 / DIN 2817 hose shank - Tinned Brass.....	256

// BSPP MALE THREADED FITTING

BSPP Male - Serrated hose shank with collar suitable also for safety clamps EN 24 420-3 / DIN 2817 - Aluminium.....	257
---	-----

// SAFETY CLAMP EN 14 420-3 / DIN 2817

Safety clamps - Aluminium.....	257
--------------------------------	-----

// SERRATED FERRULE

Serrated ferrule - for aviation - Plated Steel.....	258
---	-----

// SANDBLAST

// SANDBLAST - QUICK COUPLING

Quick coupling complete with seal - Malleable iron.....	260
Quick coupling complete with seal - PA-Nylon.....	260

// SANDBLAST - NOZZLE HOLDER

Nozzle holder - BSPP Female - Aluminium.....	261
Nozzle holder - BSPP Female - PA-Nylon.....	261
Nozzle holder - Female coarse thread - Aluminium.....	261

// INDUSTRIAL FITTINGS

Nozzle holder - Female coarse thread - PA-Nylon.....261

// SANDBLAST - ADAPTER

Sandblast complete with seal - BSPP Female - Malleable iron.....262
 Sandblast complete with seal - BSPP Female - PA-Nylon.....262

// MORTAR**// MORTAR - HOSE SHANK**

System 22 - Male adapter - Hose shank - Malleable iron.....264
 System 23.5 - Male adapter - Hose shank - Malleable iron.....264
 System 22 - Female coupler complete with seal - Hose shank - Malleable iron.....265
 System 23.5 - Female coupler complete with seal - Hose shank - Malleable iron.....265
 BSPP Male - Hose shank - Plated steel.....265

// MORTAR - FERRULE & CRIMPING RING

Crimping ring - Aluminium.....266

// CONCRETE**// CONCRETE COUPLING - VICTAULIC COMPATIBLE STYLE**

Hardened steel hose shank complete with pre-crimped ferrule.....268

// CONCRETE COUPLING - SHOULDERED STYLE

Hardened steel hose shank complete with pre-crimped ferrule.....268

// CONCRETE COUPLING - CALIFORNIA STYLE

Hardened steel hose shank complete with pre-crimped ferrule.....269

// CONCRETE COUPLING - SCHWING STYLE

Female - Hardened steel hose shank complete with pre-crimped ferrule.....269
 Male - Hardened steel hose shank complete with pre-crimped ferrule.....269

// CONCRETE COUPLING - THREADED STYLE

BSPT Male - Hardened steel hose shank complete with pre-crimped ferrule.....270
 NPT Male - Hardened steel hose shank complete with pre-crimped ferrule.....270
 BSPP Female - Hardened steel hose shank complete with pre-crimped ferrule.....270

// FLANGED FITTING**// FIXED FLANGE - EN 1092-1 PN10/16**

Serrated hose shank with pre-crimped ferrule - Plated steel.....272
 Serrated hose shank with pre-crimped ferrule - Stainless steel 316.....272
 Serrated hose shank with collar - Plated steel.....273
 Serrated hose shank with collar - Stainless steel 316.....273

// FIXED FLANGE - ASME ANSI B 16.5 - ASA 150

Serrated hose shank with pre-crimped ferrule - Plated steel.....274
 Serrated hose shank with pre-crimped ferrule - Stainless steel 316.....274
 Serrated hose shank with collar - Plated steel.....275

// INDUSTRIAL FITTINGS

Serrated hose shank with collar - Stainless steel 316..... 275

// SWIVEL FLANGE - EN 1092-1 PN10/16

Serrated hose shank with pre-crimped ferrule - Plated steel..... 276
 Serrated hose shank with pre-crimped ferrule - Stainless steel 316..... 276
 Serrated hose shank with collar - Plated steel..... 277
 Serrated hose shank with collar - Stainless steel 316..... 277
 EN 14 420-2 / DIN 2817 hose shank - Plated steel..... 278
 EN 14 420-2 / DIN 2817 hose shank - Stainless steel 316..... 278

// SWIVEL FLANGE - ASME ANSI B 16.5 - ASA 150

Serrated hose shank with pre-crimped ferrule - Plated steel..... 279
 Serrated hose shank with pre-crimped ferrule - Stainless steel 316..... 279
 Serrated hose shank with collar - Plated steel..... 280
 Serrated hose shank with collar - Stainless steel 316..... 280

// FLANGE - FERRULE

Serrated ferrule - Plated steel..... 281
 Serrated ferrule - Stainless steel 316..... 281

// FIXED FLANGE - SPLIT COUPLING - AS 2129 TABLE D

Split coupling - Serration for 706AA smooth cover hose - Aluminium..... 281

// CLAMPS

// EAR PINCH CLAMP

Clamp - 1-ear with inner ring - W1 (Plated steel)..... 283
 Clamp - 1-ear with inner ring - W4 (Stainless steel 304)..... 283
 Clamp - 2-ears - W1 (Plated steel)..... 284
 Clamp - 2-ears - W4 (Stainless steel 304)..... 284

// MINICLAMP

Miniclamp - 1 bolt - W1 (Plated steel)..... 285

// BAND-IT SYSTEM

Banding tool - Plated steel..... 286
 Banding bands - Stainless steel 304..... 286
 Banding buckles - Stainless steel 304..... 286

// WORM GEAR CLAMP

Clamp - 1 bolt - DIN 3017 - W1 (Plated steel)..... 287
 Clamp - 1 bolt - DIN 3017 - W5 (Stainless steel 316)..... 287

// SUPERCLAMP

Clamp - 1 bolt - W1 (Plated steel)..... 288
 Clamp - 1 bolt - W4 (Stainless steel 304)..... 289

// PW-CLAMP

Clamp - 1 bolt - W1 (Plated steel)..... 290
 Clamp - 1 bolt - W5 (Stainless steel 316)..... 290
 Clamp - 2 bolts - W1 (Plated steel)..... 291

// INDUSTRIAL FITTINGS

Clamp - 2 bolts - W5 (Stainless steel 316).....292

// SAFETY CLAMP EN 14 420-3 / DIN 2817

Safety clamps - Aluminium.....293

Safety clamps - Stainless steel 316.....293

// SAFETY CLAMPS FLEXOLINE®

Safety clamps - Aluminium.....294

// DOUBLE BOLT CLAMP WITH SADDLES

Clamp - DIN 20039 A - Malleable iron.....295

Clamp - Malleable iron.....295

Clamp - Plated steel.....295

// RUBBER LINED PIPE CLIP

Clip - DIN 3016 - EPDM/W1 (Plated steel).....296

Clip - SMS - EPDM/W1 (Plated steel).....296

// FERRULE & CRIMPING RING**// CRIMPING RING**

Crimping ring - Aluminium.....298

// SMOOTH FERRULE

Smooth ferrule - Aluminium.....299

Smooth ferrule - Stainless steel 304.....299

// SERRATED FERRULE

Serrated ferrule - Stainless steel 316.....300



HEADQUARTER

Alfagomma SpA

Via Torri Bianche 1

20871 Vimercate (MB) Italy

marketing@alfagomma.com

www.alfagomma.com